

SP6123A Buck Regulator 1V/1.5A Out

Date: March 30, 2006

Designed by: Brian Kennedy
Part Number: SP6123ACN

Application Description: Small layout size (16X16mm) from 3V_{in} to 6V_{in}

Electrical Requirements:

Input Voltage	3.0V – 6.0V
Output Voltage	1.0V
Output Current	up to 1.5A

Circuit Description:

This application has been designed for applications that require high efficiency, small size and low EMI. The input voltage range is from 3.0V to 6.0V and is efficiently bucked down to a 1.0V output. All the external components have been optimized for an output current of 1.5A and have been laid out for small size and to minimize EMI related to harmonics generated from the fundamental operating frequency of 500 KHz.

This report includes the application schematic complete with component part numbers and figures 1-8 illustrating electrical performance of the design.

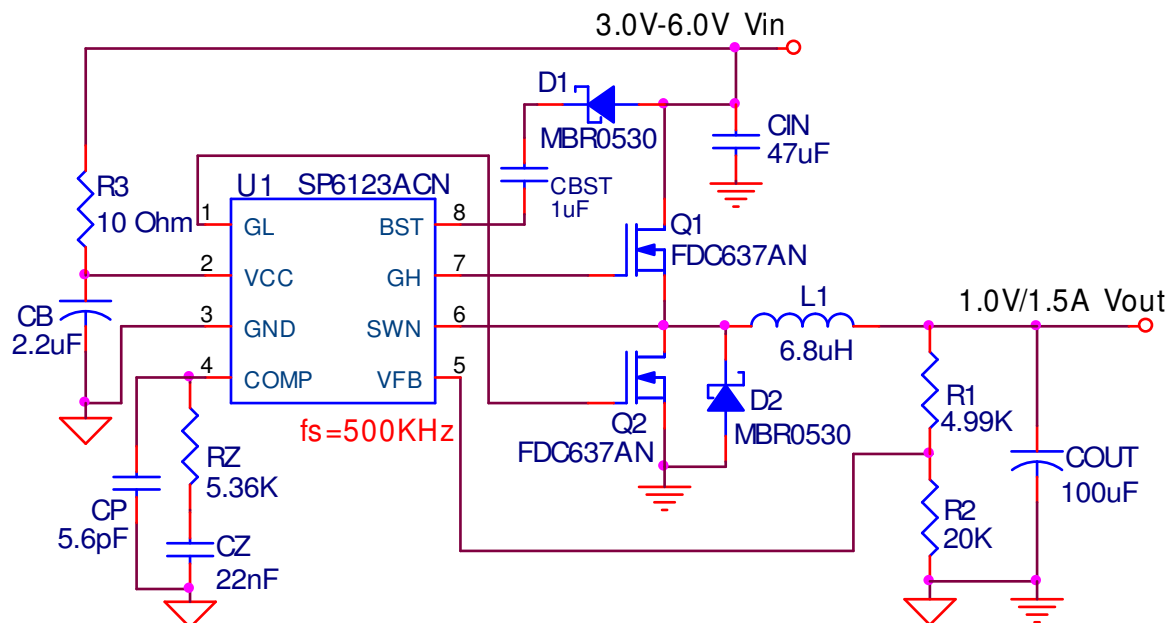

Application Schematic

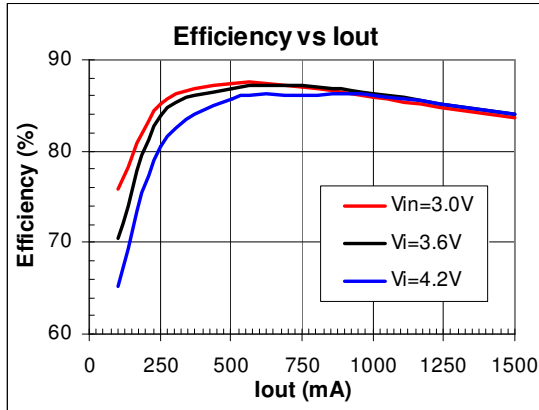

Figure 1. Efficiency Graph

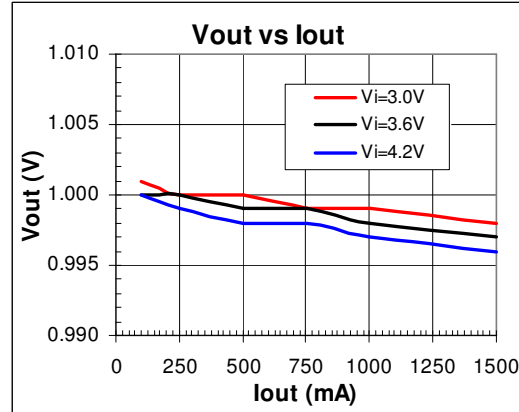

Figure 2. Vout Regulation Graph

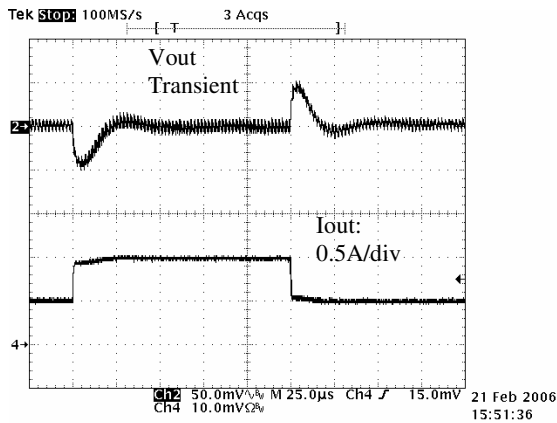

Figure 3. Load Step
Vin=4.2V, Iout=0.5A - 1.0A

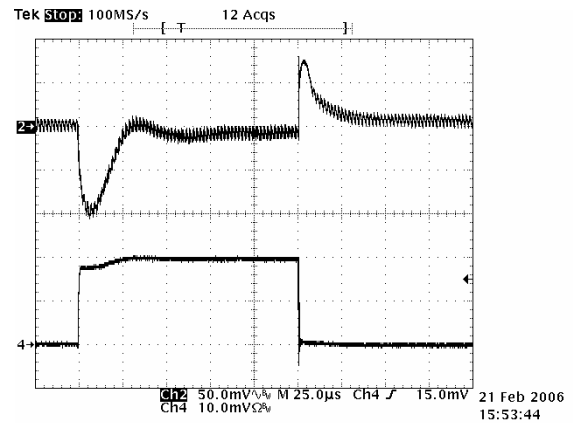

Figure 4. Load Step
Vin=4.2V, Iout=0A - 1.0A

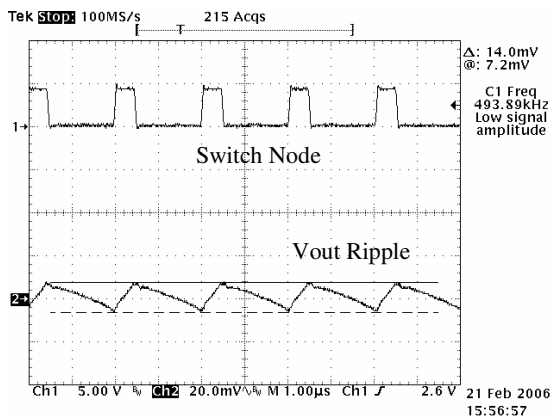

Figure 5. Switch Node, Output Noise
Vin=4.2V No Load

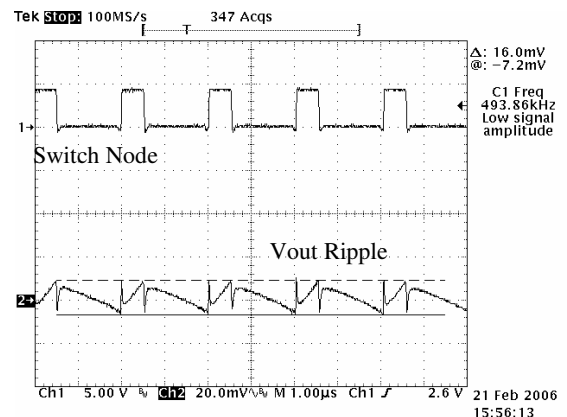

Figure 6. Switch Node, Output Noise
Vin=4.2V, Iout=1.0A

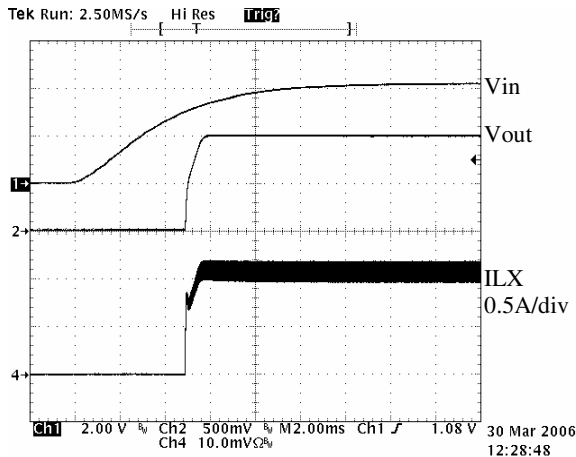

Figure 7. Slow Start up
 $V_{in}=4.2V$, $I_{out}=1.0A$

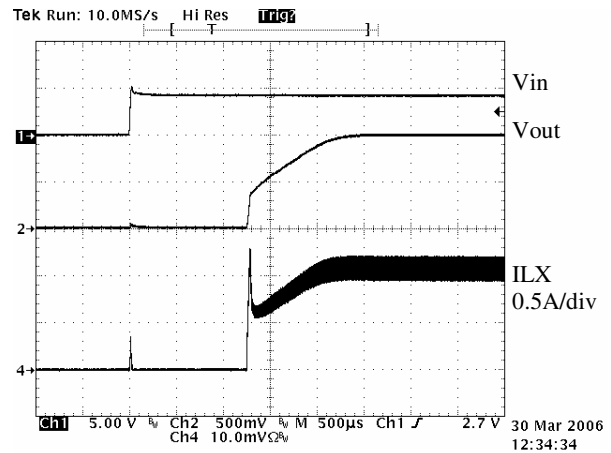

Figure 8. Fast Start up
 $V_{in}=4.2V$, $I_{out}=1.0A$

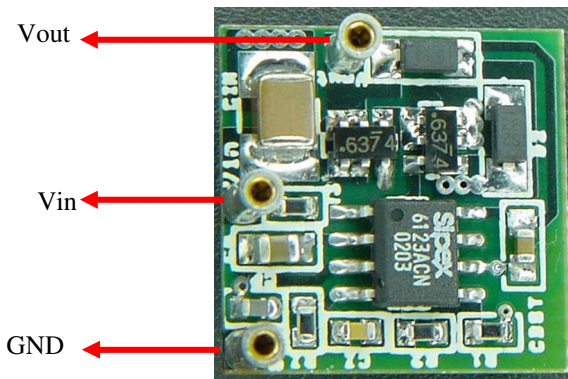

Figure 12. Evaluation board Top layer
 Bottom layer
 (16mmX16mm)

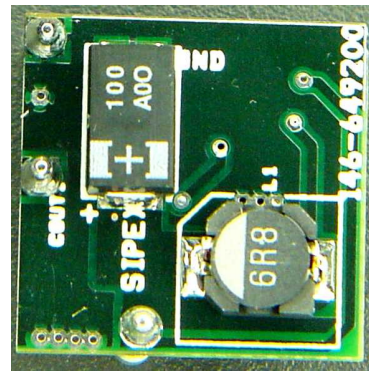

Figure 13. Evaluation board