

# 40V 1.5A/3A/5A/8A Synchronous Step-Down Regulators

## OVERVIEW

XR76201	40V, 1.5A
XR76203	40V, 3A
XR76205	40V, 5A
XR76208	40V, 8A

## FEATURES

- Controller, drivers, bootstrap diode and MOSFETs integrated in one package
- 1.5A, 3A, 5A and 8A step-down regulators
  - 5V to 40V operating range
  - 3V to 40V PVIN with 5V bias
  - 4.5V to 5.5V single supply operation
  - $\geq 0.6V$  adjustable output voltage
- Patented COT control
  - Programmable 200ns-2 $\mu$ s on-time (100ns-1 $\mu$ s XR76201)
  - Constant 100kHz-800kHz switching frequency (400kHz-800kHz XR76201)
- Selectable CCM or CCM/DCM
  - CCM/DCM for high efficiency at light load
  - CCM for constant frequency at light load
- Programmable hiccup current limit with thermal compensation
- Precision enable and Power Good flag
- Programmable soft-start
- Common scalable footprint 5mm x 5mm QFN package

## BENEFITS

- Excellent line and load regulation compared to standard COT
- Stable with ceramic output capacitors
- No compensation required
- Fast transient response with ability to work with low ESR capacitors

## APPLICATIONS

- Automotive infotainment
- UAV or drone power systems
- Industrial FPGA, DSP and SoC power
- Industrial automation

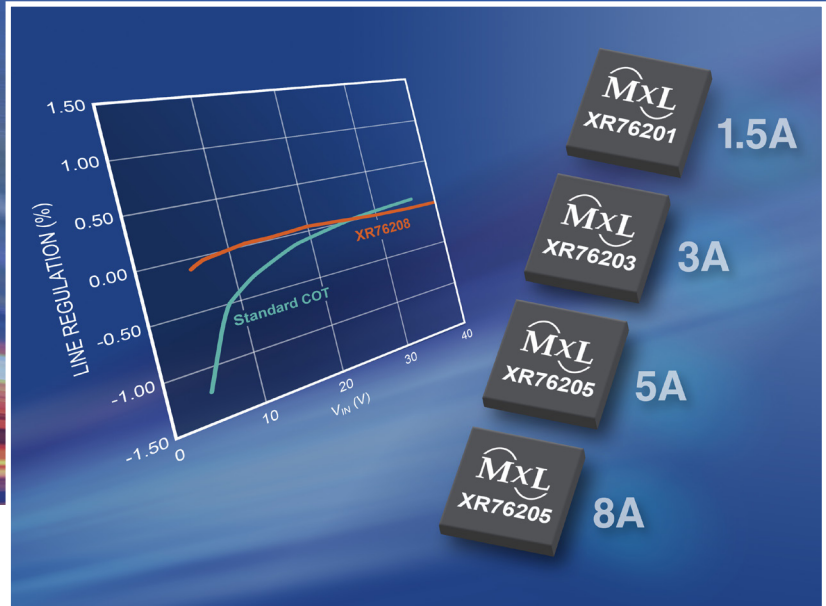

The **XR76201**, **XR76203**, **XR76205** and **XR76208** are synchronous step-down regulators combining the controller, drivers, bootstrap diode and MOSFETs in a single package for point-of-load supplies. The XR76201, XR76203, XR76205 and XR76208 have load current ratings of 1.5A, 3A, 5A and 8A, respectively. A wide 5V to 40V input voltage range allows for single supply operation from industry standard 24V  $\pm 10\%$ , 18V to 36V and rectified 18V<sub>AC</sub> and 24V<sub>AC</sub> rails.

With a proprietary emulated current mode Constant On-Time (COT) control scheme, the XR76201, XR76203, XR76205 and XR76208 provide extremely fast line and load transient response using ceramic output capacitors. They require no loop compensation, simplifying circuit implementation and reducing overall component count. The control loop also provides 0.07% load and 0.15% line regulation and maintains constant operating frequency. A selectable power saving mode allows the user to operate in Discontinuous Conduction Mode (DCM) at light current loads thereby significantly increasing the converter efficiency. A host of protection features, including over-current, over temperature, short-circuit and UVLO, helps achieve safe operation under abnormal operating conditions. These 40V regulators deliver power to a wide range of industrial, networking and telecom equipment.

# XR7620x

Part Number	I <sub>OUT</sub> (A)	V <sub>IN</sub> Range (V)	V <sub>OUT</sub> Range (V)	Frequency (kHz)	Accuracy (%)	Efficiency (%)	Package (mm)	Features
XR76201	1.5	3 to 40	0.6 to 30	100 to 800	0.5	95	5 x 5 QFN	<ul style="list-style-type: none"> <li>Patented COT provides fast transient response with excellent line and load regulation</li> <li>UVLO, OTP, soft-start, adjustable hiccup current limit and short-circuit protection</li> </ul>
XR76203	3					95		
XR76205	5					96		
XR76208	8					96		

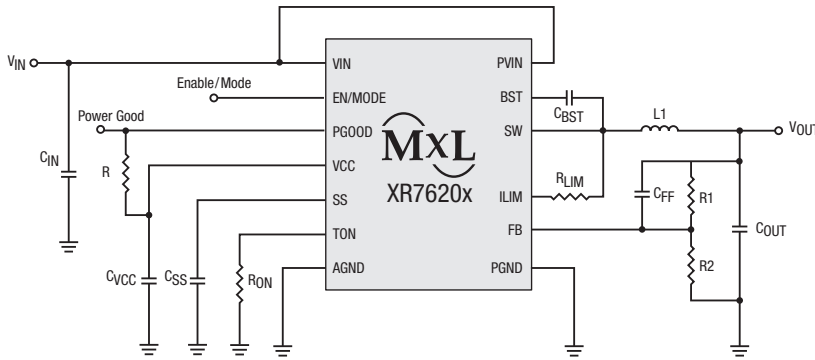

Typical Schematic

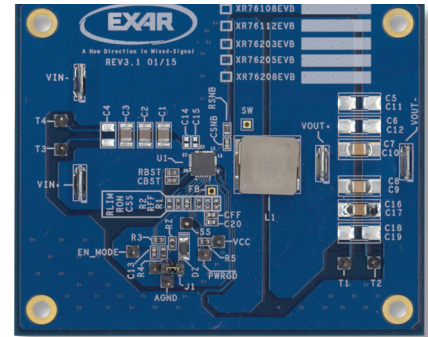

XR76201/03/05/08 Evaluation Board

XR76201 Efficiency

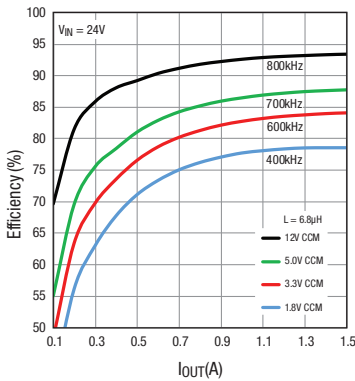

XR76203 Efficiency

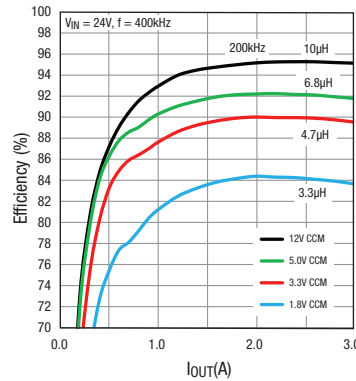

XR76205 Efficiency

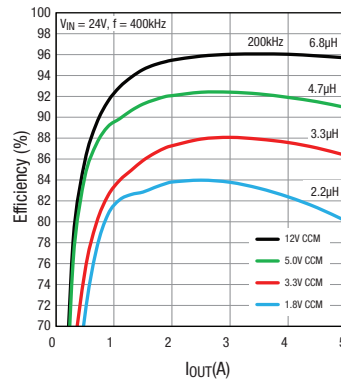

XR76208 Efficiency

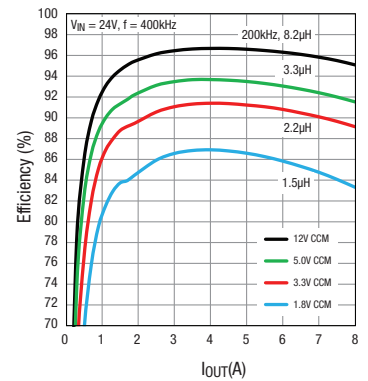

**Corporate Headquarters:**  
 5966 La Place Court  
 Suite 100  
 Carlsbad, CA 92008  
 Tel.: +1 (760) 692-0711  
 Fax: +1 (760) 444-8598  
[www.maxlinear.com](http://www.maxlinear.com)

The content and information contained in this document is furnished for informational or general marketing purposes only, is subject to change without notice, and should not be construed as a commitment by MaxLinear, Inc. MaxLinear, Inc. assumes no responsibility or liability for any errors, inaccuracies, or incompleteness that may appear in the informational content contained in this guide.

Reproduction, in part or whole, without the prior written consent of MaxLinear, Inc. is prohibited. MaxLinear, the MaxLinear logo, and any MaxLinear trademarks; MxL, Full-Spectrum Capture, FSC, G.now, and AirPHY are all trademarks of MaxLinear, Inc. or one of MaxLinear's subsidiaries in the U.S.A. and other countries. Other company trademarks and product names appearing herein are the property of their respective owners.

© 2019 MaxLinear, Inc. All rights reserved.