

ENVISIONING • EMPOWERING • EXCELLING



MxL83411
Quad Receiver
EVK User Manual

Revision History

Document No.	Release Date	Change Description
029UMR00	November 2, 2023	Initial release.

Table of Contents

Introduction	1
Ordering Information	2
Evaluation Kit Overview	2
EVK Schematic	3
EVK PCB Layers (NSOIC16 Package)	4
EVK PCB Layers (TSSOP16 Package)	7
EVK Bill of Material (BOM)	10
Power Supply Recommendations	11
Layout Recommendations.....	14

List of Figures

Figure 1: Top View of the MxL83411 (NSOIC16) EVK.....	1
Figure 2: Top View of the MxL83411 (TSSOP16) EVK.....	1
Figure 3: MxL83411 Quad Receiver.....	2
Figure 4: MxL83411 EVK Schematic.....	3
Figure 5: EVK PCB Layer 1—Top View (NSOIC16)	4
Figure 6: EVK PCB Layer 2—GND Plane (NSOIC16)	5
Figure 7: EVK PCB Layer 3—Power Plane (NSOIC16)	5
Figure 8: EVK PCB Layer 4—Bottom View (NSOIC16)	6
Figure 9: EVK PCB Layer 1—Top View (TSSOP16).....	7
Figure 10: EVK PCB Layer 2—GND Plane (TSSOP16)	8
Figure 11: EVK PCB Layer 3—Power Plane (TSSOP16)	8
Figure 12: EVK PCB Layer 4—Bottom View (TSSOP16)	9

List of Tables

Table 1: EVK Ordering Part Number	2
Table 2: Bill of Materials for NSOIC16.....	10
Table 3: Bill of Materials for TSSOP16.....	10
Table 4: EVK Header Pin Description	11
Table 5: EVK Header Pin Description and Default Settings	11

Introduction

This document is used for the evaluation kits (EVKs) of the MxL83411 device. These EVKs provide a platform to evaluate the features and performance of the MxL83411.

EVK Setup and Pre-configuration

- The EVK is pre-configured for global enable with $RE = V_{CC}$ and $REb = GND$. All four receiver outputs are enabled simultaneously in this configuration.
- Apply $V_{CC} = 5.0V$ bench power supply to header J1 at pin 2 (J1.2) or pin3(J1.3).
- Apply GND connection to J1 at pin 1 (J1.1)
- J14 and J16 are GND probe points on the EVK.
- When the power V_{CC} is applied at header J1, the LED at location D1 is ON.
- Screw terminal block J5, J30, J26, and J18 are inputs to receiver channel 1, channel 2, channel 3, and channel 4 respectively.
- Apply differential signals at J5, J30, J26, and J18. Monitor receiver outputs at J7, J10, J23, and J20.
- [Figure 4 on page 4](#) shows the schematic of the EVK.

For more information about the MxL83411 device, refer to the *MxL83411 Data Sheet (281DS)*.

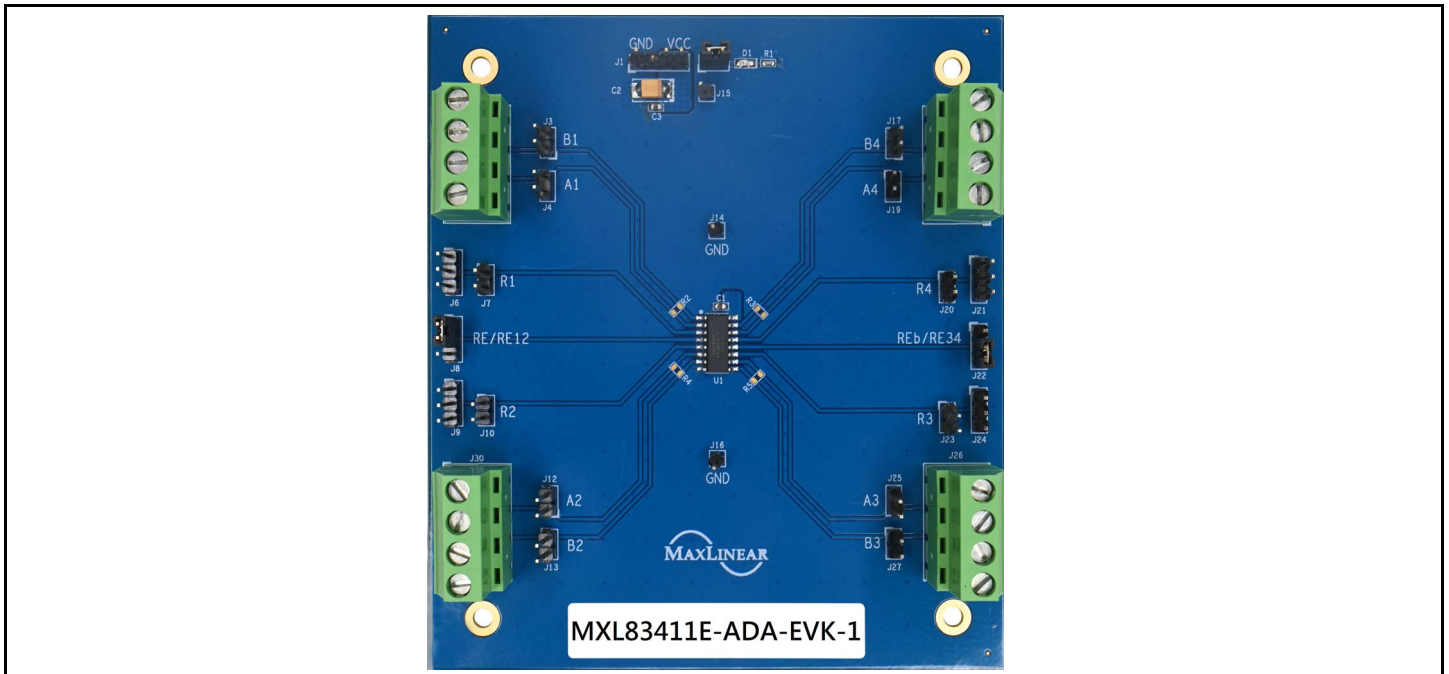

Figure 1: Top View of the MxL83411 (NSOIC16) EVK

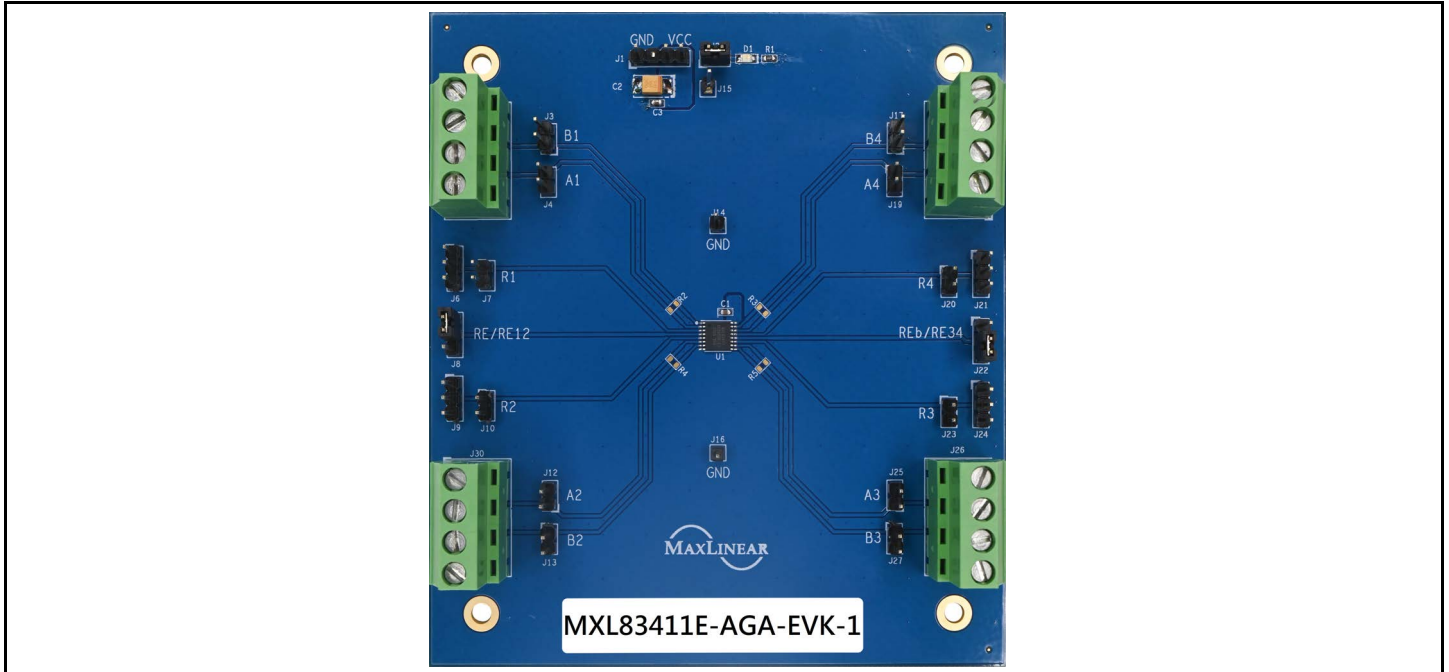

Figure 2: Top View of the MxL83411 (TSSOP16) EVK

Ordering Information

The following table lists the ordering part number for this evaluation kit.

Table 1: EVK Ordering Part Number

EVK Part Number	Description
MXL83411E-ADA-EVK-1	MxL83411 Evaluation Kit NSOIC16
MXL83411E-AGA-EVK-1	MxL83411 Evaluation Kit TSSOP16

Evaluation Kit Overview

The following figures show the pin configuration and logic diagram of the MxL83411 device.

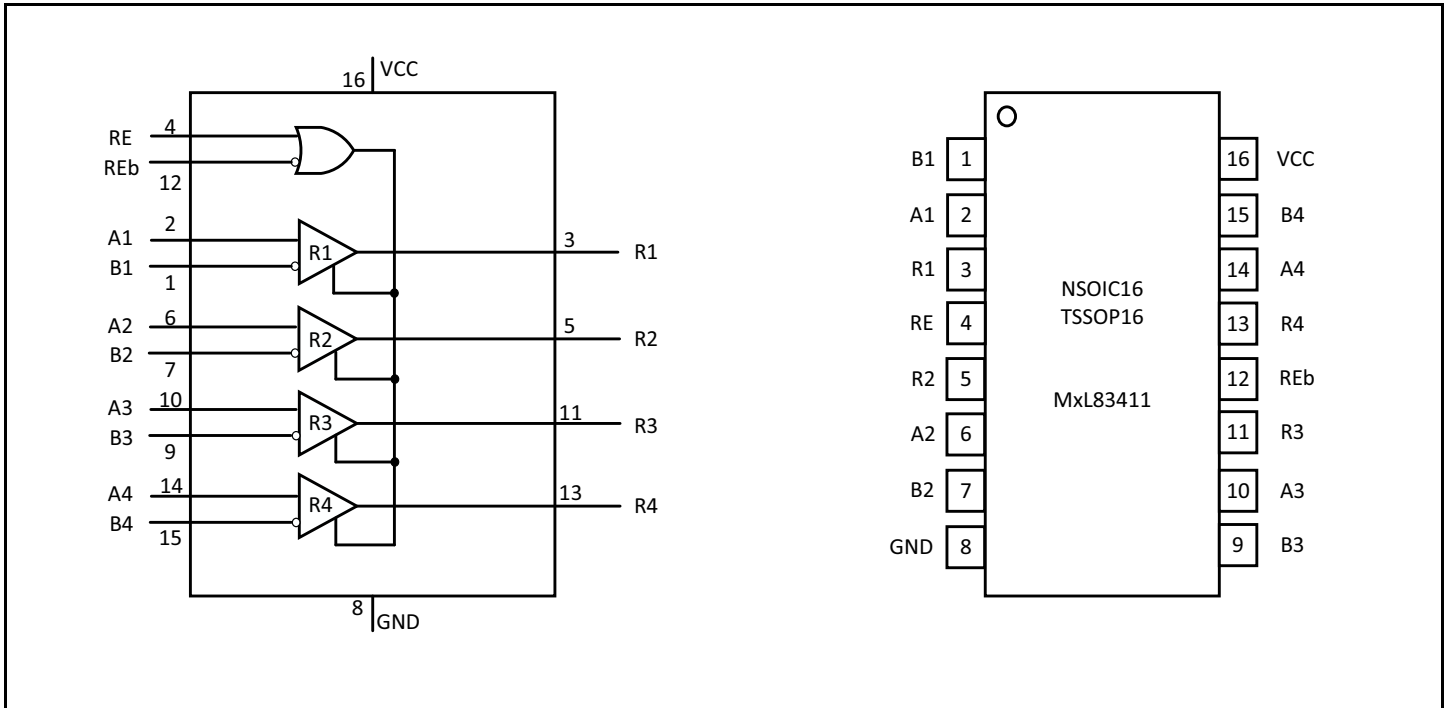

Figure 3: MxL83411 Quad Receiver

EVK Schematic

The following figure show the EVK schematic design of the MxL83411 device.

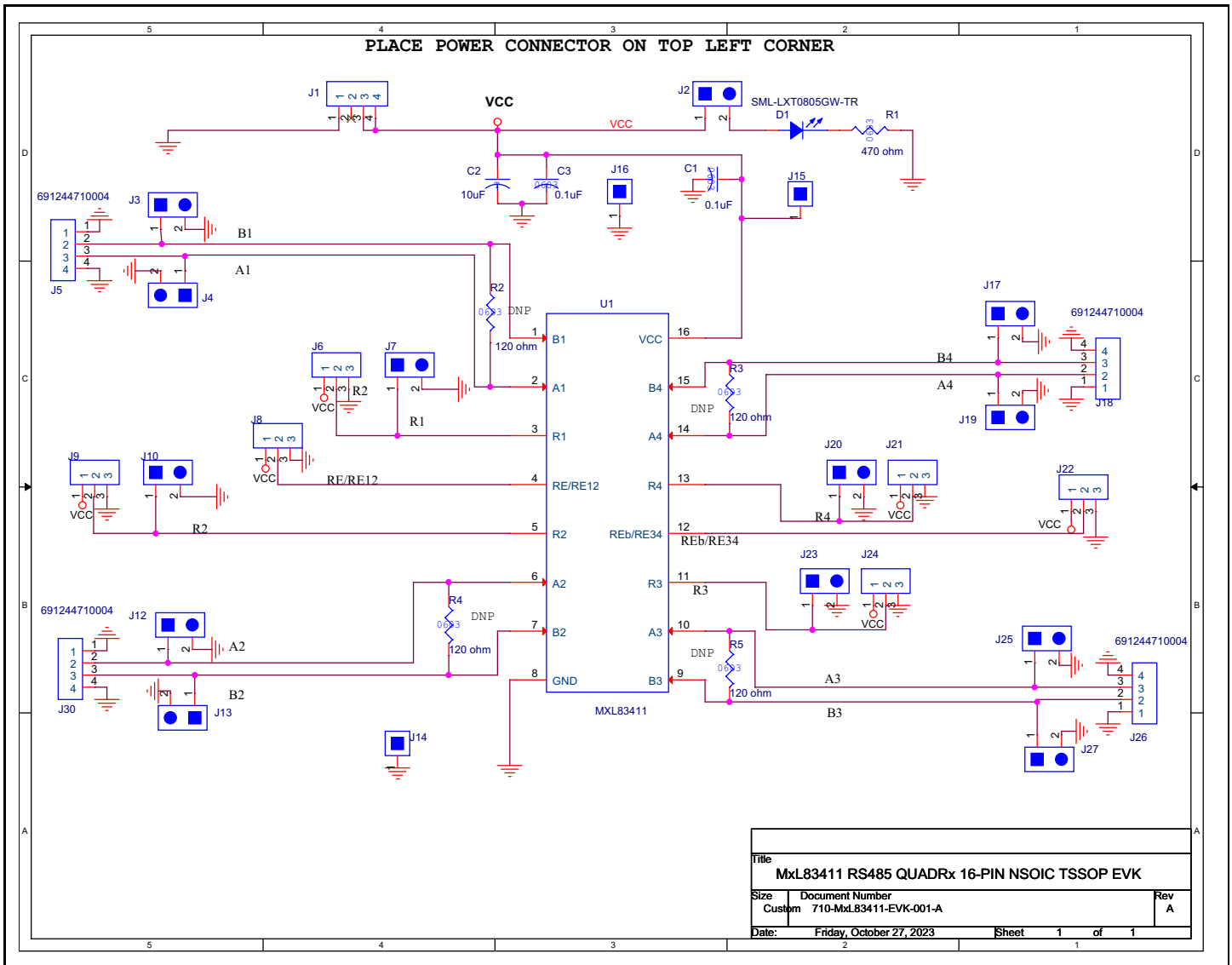

Figure 4: MxL83411 EVK Schematic

EVK PCB Layers (NSOIC16 Package)

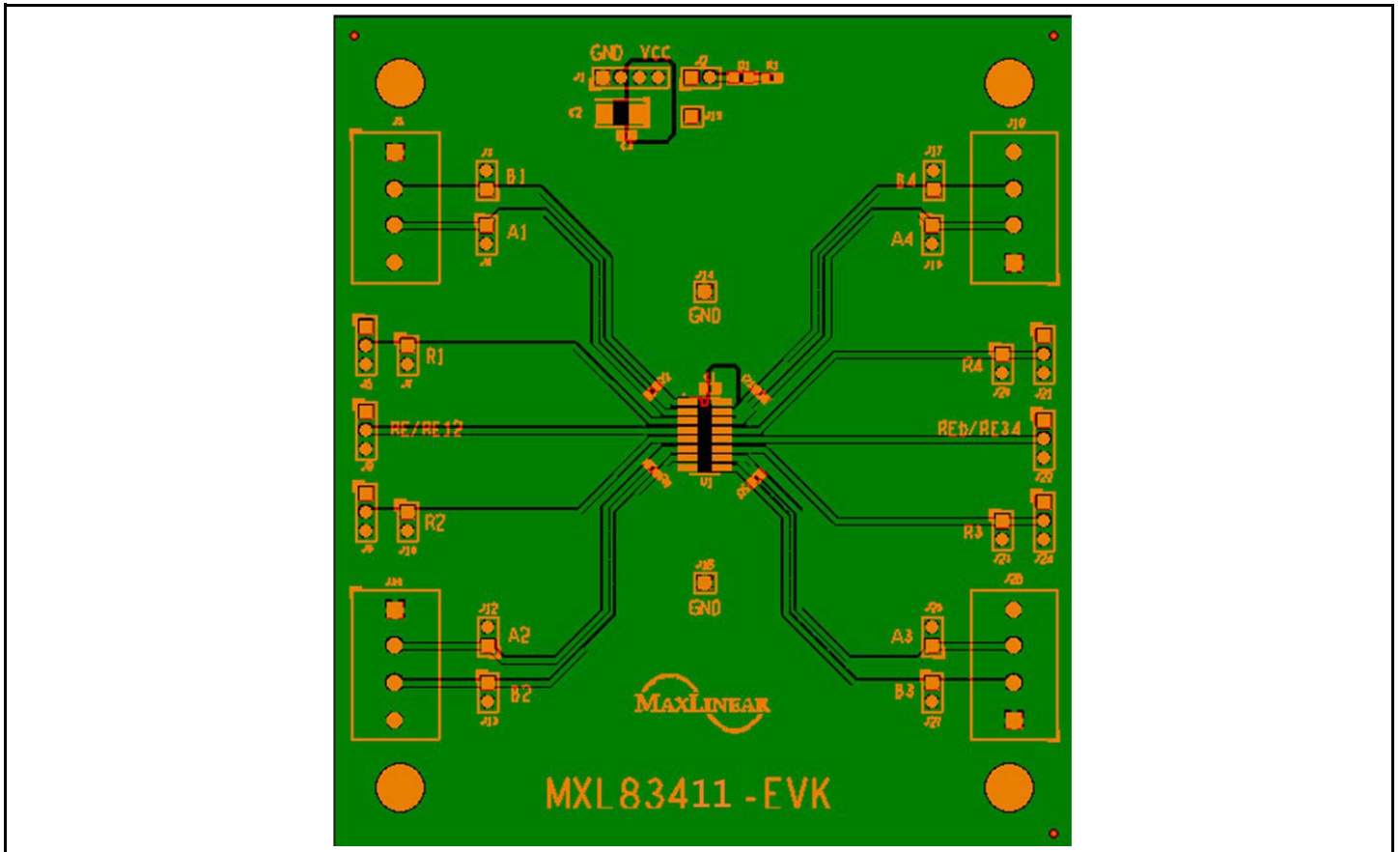

Figure 5: EVK PCB Layer 1—Top View (NSOIC16)

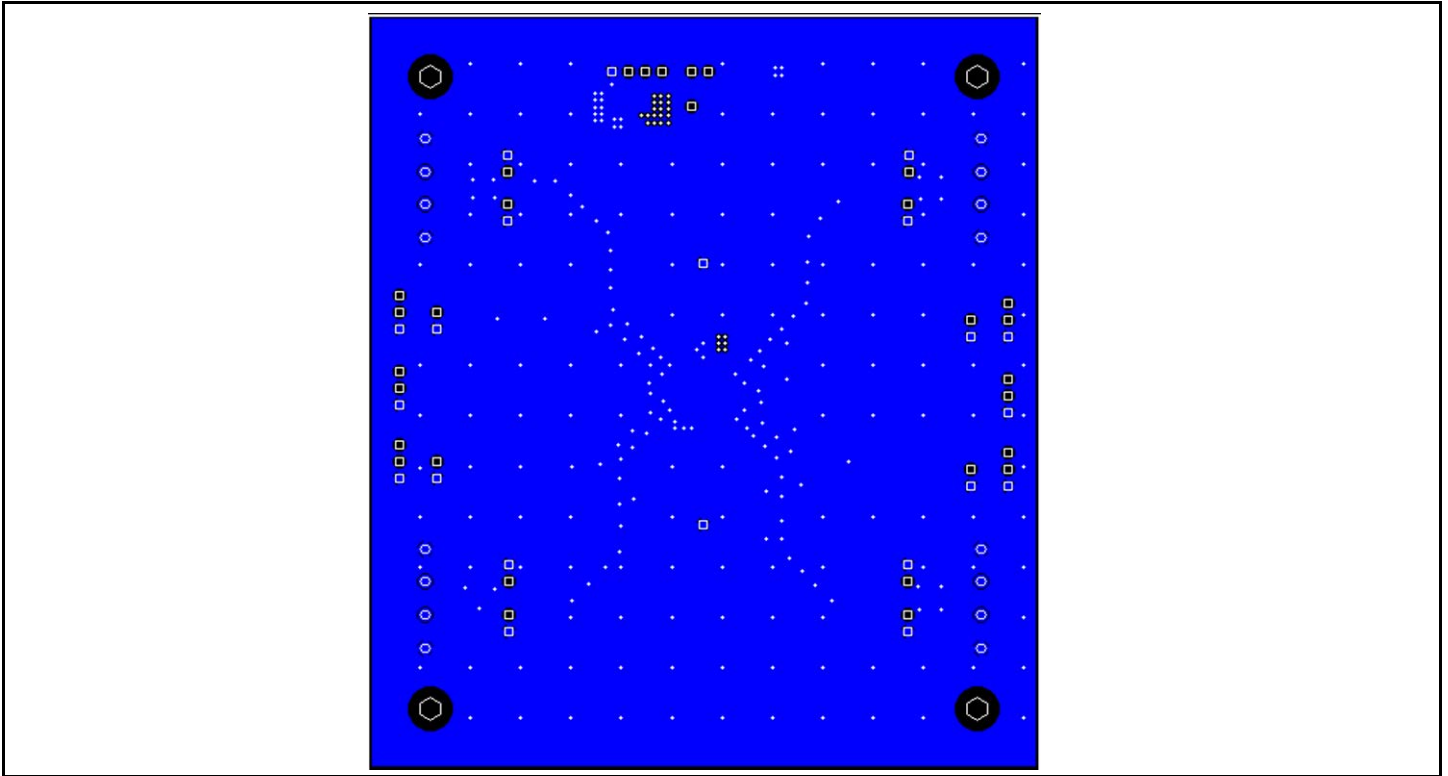

Figure 6: EVK PCB Layer 2—GND Plane (NSOIC16)

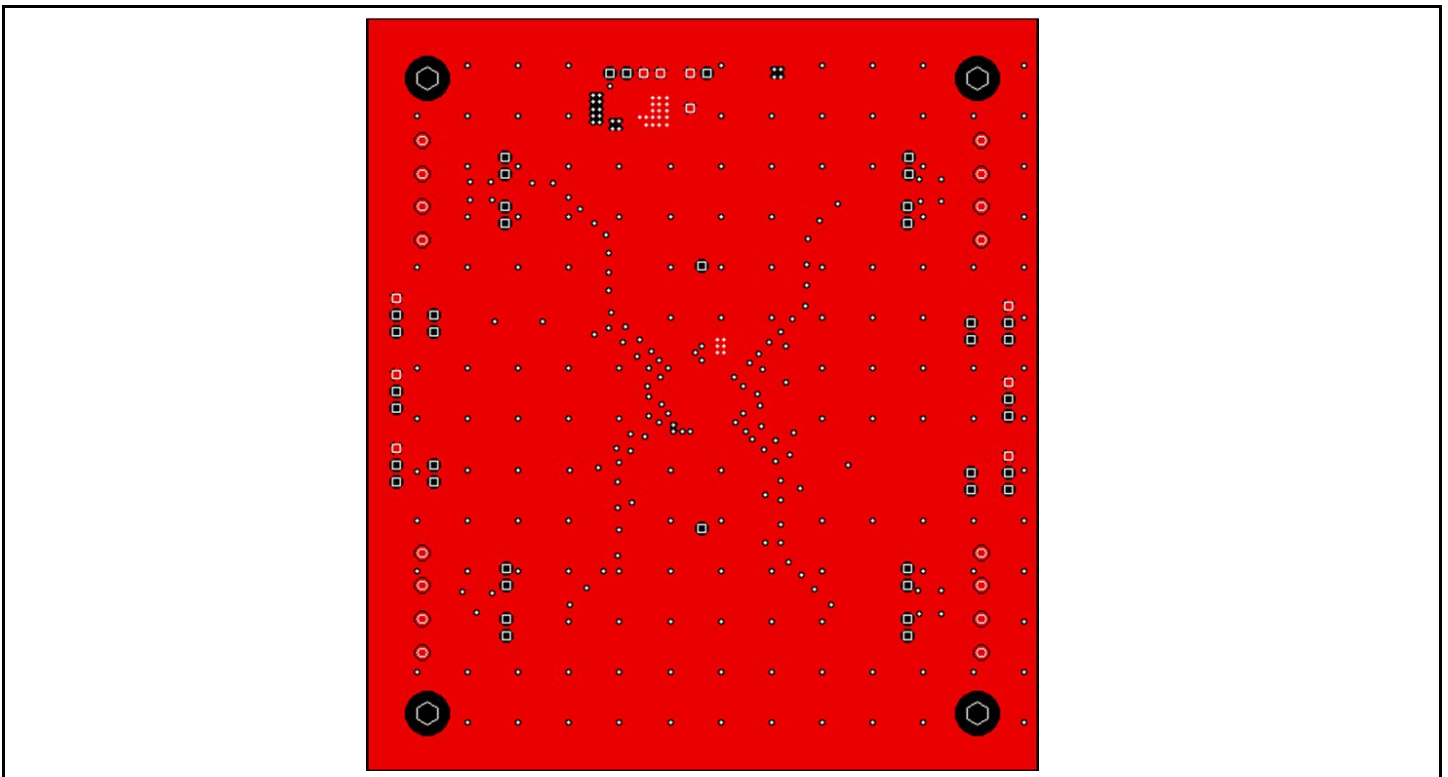

Figure 7: EVK PCB Layer 3—Power Plane (NSOIC16)

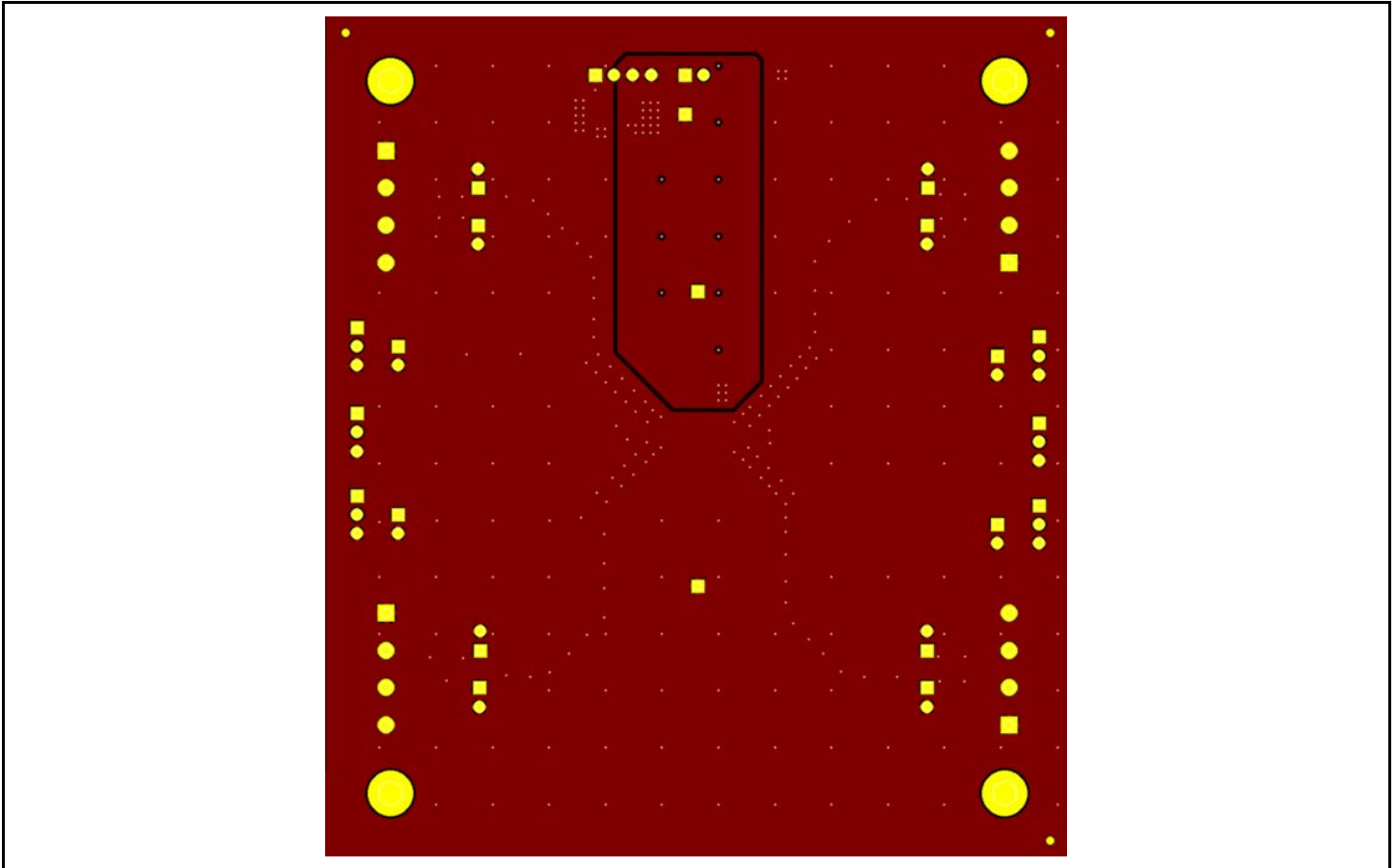

Figure 8: EVK PCB Layer 4—Bottom View (NSOIC16)

EVK PCB Layers (TSSOP16 Package)

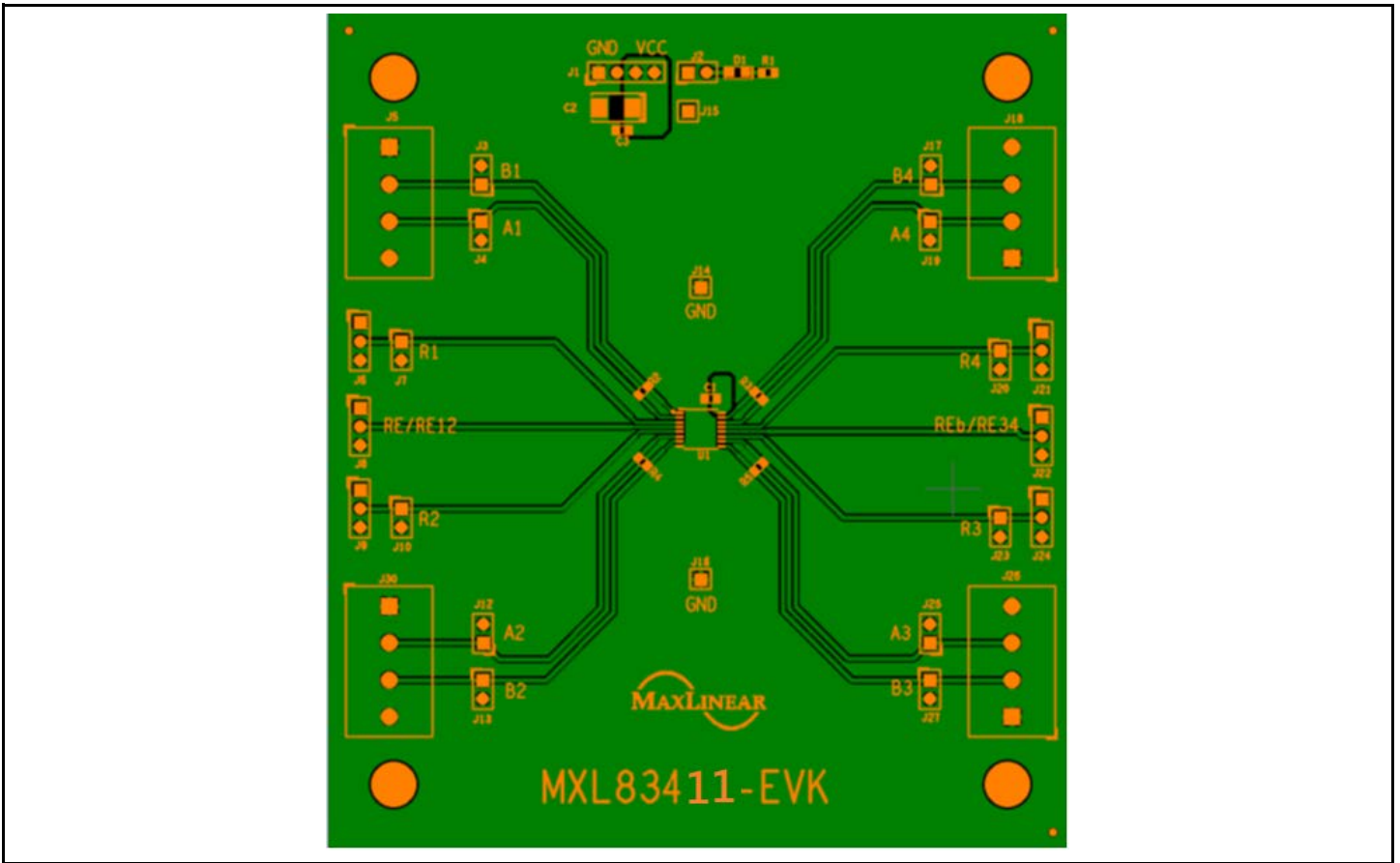

Figure 9: EVK PCB Layer 1—Top View (TSSOP16)

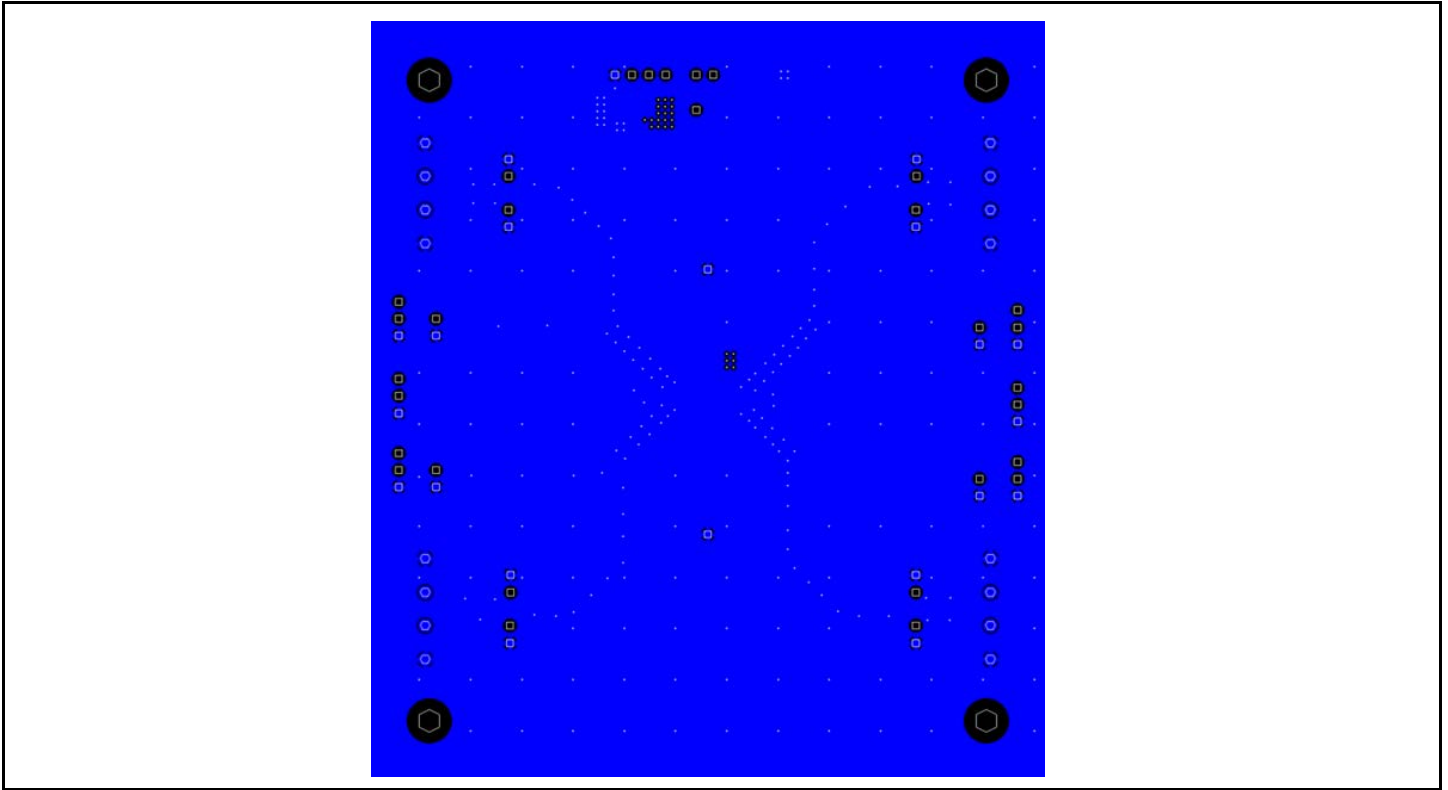

Figure 10: EVK PCB Layer 2—GND Plane (TSSOP16)

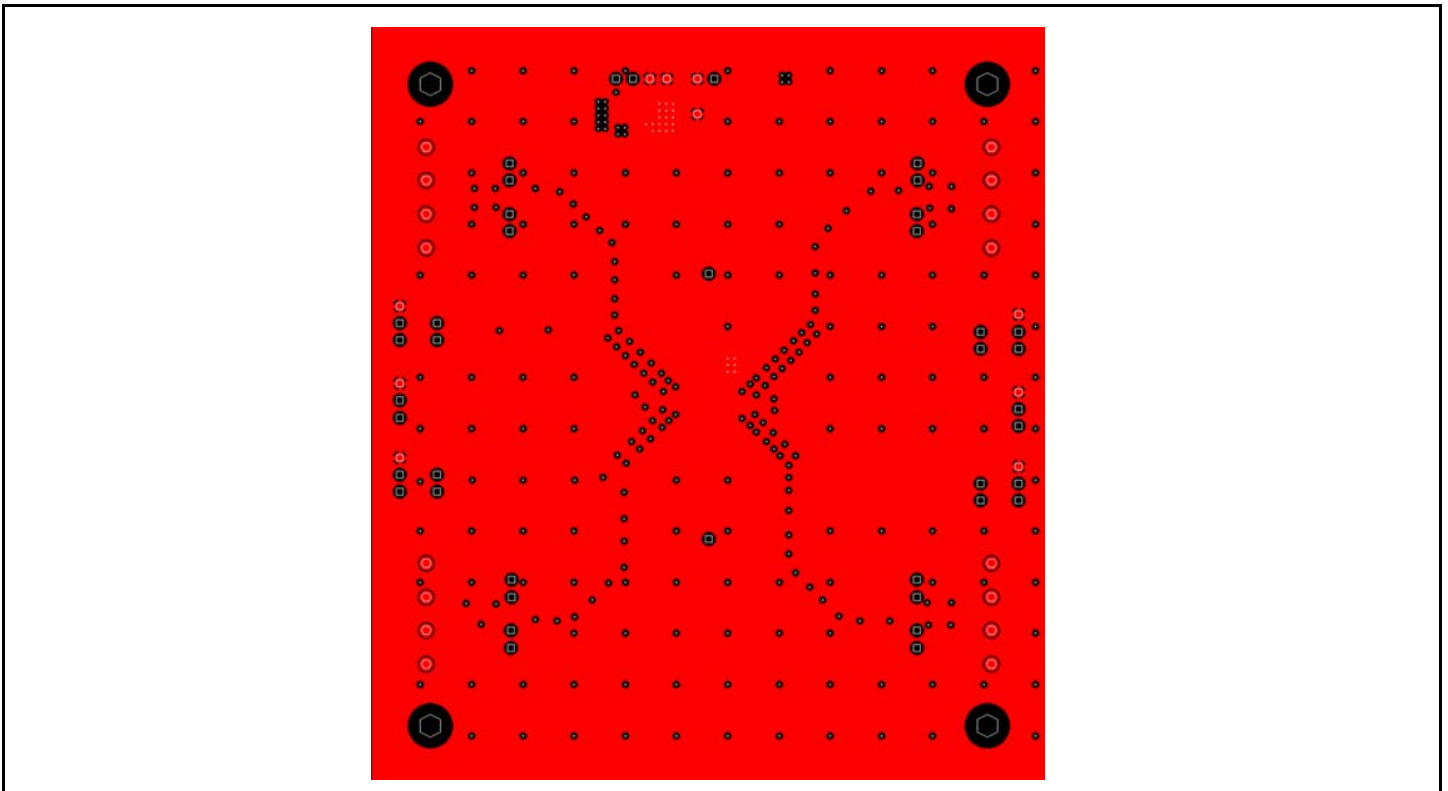

Figure 11: EVK PCB Layer 3—Power Plane (TSSOP16)

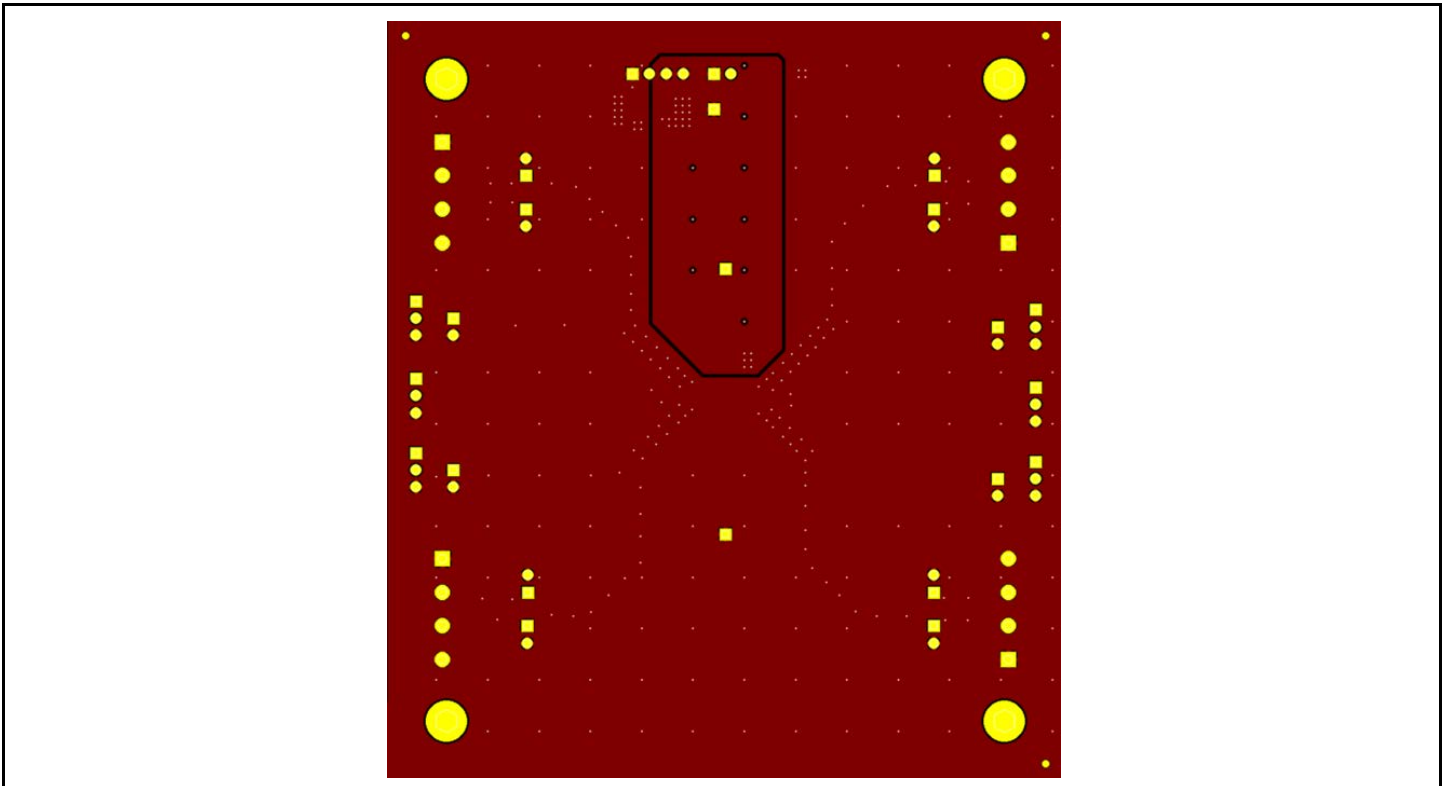

Figure 12: EVK PCB Layer 4—Bottom View (TSSOP16)

EVK Bill of Material (BOM)

Table 2: Bill of Materials for NSOIC16

Item	Quantity	Reference	Manufacturer	Part
1	2	C1, C3	Kemet	C0603C104K5RAC7081, 0.1UF 50V, 0603 X7R
2	1	C2	AVX	478-5235-1-ND, TANTALUM, 10 μ F, 16V, 500m Ω , 2312
3	1	D1	Lumex	67-1553-1-ND LED GREEN DEFUSED SMD, 0805
4	1	J1	Samtec	TSW-104-07-G-S CONN. HEADER 1 \times 4, 2.54mm, 4PIN
5	13	J2, J3, J4, J7, J10, J12, J13, J17, J19, J20, J23, J25, J27	Samtec	TSW-102-07-G-S CONN.HEADER, 1 \times 2, 2mm, 2PIN
6	4	J5, J18, J26, J30	Würth Electronics	732 691 244 710 004 5.00 MM terminal block
7	6	J6, J8, J9, J21, J22, J24	Samtec	TSW-103-07-G-S CONN.HEADER, 1 \times 3, 2mm, 1PIN
8	3	J14, J15, J16	Samtec	TSW-101-07-G-S CONN.HEADER, 1 \times 1, 2mm, 1PIN
9	1	R1	Xicon	ERJ-3EKF4700V RES SMD, 470 Ω , 1%, 1/10W, 0603
10	4	R2, R3, R4, R5. Termination resistors. Optional, not stuff by default.	Xicon	ERJ-3EKF1200V RES SMD, 120 Ω , 1%, 1/10W, 0603
11	1	U1	MaxLinear	MXL83411E-ADA-R (NSOIC16)

Table 3: Bill of Materials for TSSOP16

Item	Quantity	Reference	Manufacturer	Part
1	2	C1, C3	Kemet	C0603C104K5RAC7081, 0.1UF 50V, 0603 X7R
2	1	C2	AVX	478-5235-1-ND, TANTALUM, 10 μ F, 16V, 500m Ω , 2312
3	1	D1	Lumex	67-1553-1-ND LED GREEN DEFUSED SMD, 0805
4	1	J1	Samtec	TSW-104-07-G-S CONN. HEADER 1 \times 4, 2.54mm, 4PIN
5	13	J2, J3, J4, J7, J10, J12, J13, J17, J19, J20, J23, J25, J27	Samtec	TSW-102-07-G-S CONN.HEADER, 1 \times 2, 2mm, 2PIN
6	4	J5, J18, J26, J30	Würth Electronics	732 691 244 710 004 5.00 MM terminal block
7	6	J6, J8, J9, J21, J22, J24	Samtec	TSW-103-07-G-S CONN.HEADER, 1 \times 3, 2mm, 1PIN
8	3	J14, J15, J16	Samtec	TSW-101-07-G-S CONN.HEADER, 1 \times 1, 2mm, 1PIN
9	1	R1	Xicon	ERJ-3EKF4700V RES SMD, 470 Ω , 1%, 1/10W, 0603
10	4	R2, R3, R4, R5. Termination resistors. Optional, not stuff by default.	Xicon	ERJ-3EKF1200V RES SMD, 120 Ω , 1%, 1/10W, 0603
11	1	U1	MaxLinear	MXL83411E-AGA-R (TSSOP16)

Power Supply Recommendations

To ensure reliable operation at all data rates and supply voltages, each supply should have a ceramic capacitor of at least 100nF located as close to the supply terminals (V_{CC}) as possible. If the supply source is generated from a linear power supply/regulator, MaxLinear recommends you to use additional 10 μ F (C2) and 100nF (C3) ceramic capacitors.

Table 4: EVK Header Pin Description

J1	J1-Pin 1	J1-Pin 2	J1-Pin 3	J1-Pin 4
Name	GND	NC	V_{CC}	V_{CC}
				

Where V_{CC} = 3.0V to 5.5V

Table 5: EVK Header Pin Description and Default Settings





Header	Factory Setting	Description
J2 	Jumper 1-2	Enable power LED.
J8 	Jumper 1-2	Enable all receivers, RE = V_{CC}
J22 	Jumper 2-3	Enable all receivers, REb = GND.
R2, R3, R4, R5	Not stuff	Receiver termination resistor. Optional, not stuff by default.
J3 	Header 2 pins	<ul style="list-style-type: none"> ■ J3.1: B1 inverting input (test point). ■ J3.2: GND.
J4 	Header 2 pins	<ul style="list-style-type: none"> ■ J4.1: A1 non-inverting input (test point). ■ J4.2: GND.

Table 5: EVK Header Pin Description and Default Settings





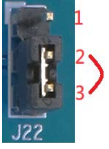



Header	Factory Setting	Description
J5 	4 Pins terminal block	<ul style="list-style-type: none"> ■ J5.1: GND. ■ J5.2: B1 inverting input. ■ J5.3: A1 non-inverting input. ■ J5.4: GND.
J6 	Header 3pins	<ul style="list-style-type: none"> ■ J6.1: V_{CC} ■ J6.2: R1 output. ■ J6.3: GND.
J7 	Header 2 pins	<ul style="list-style-type: none"> ■ J7.1: R1 output (test point). ■ J7.2: GND.
J9 	Header 3pins	<ul style="list-style-type: none"> ■ J9.1: V_{CC} ■ J9.2: R2 output. ■ J9.3: GND.
J10 	Header 2 pins	<ul style="list-style-type: none"> ■ J10.1: R2 output (test point). ■ J10.2: GND.
J12 	Header 2 pins	<ul style="list-style-type: none"> ■ J12.1: A2 non-inverting input (test point). ■ J12.2: GND.
J13 	Header 2 pins	<ul style="list-style-type: none"> ■ J13.1: B2 inverting input (test point). ■ J13.2: GND.
J30 	4 Pins terminal block	<ul style="list-style-type: none"> ■ J30.1: GND. ■ J30.2: A2 non-inverting input. ■ J30.3: B2 inverting input. ■ J30.4: GND.
J25 	Header 2 pins	<ul style="list-style-type: none"> ■ J25.1: A3 non-inverting input (test point). ■ J25.2: GND.

Table 5: EVK Header Pin Description and Default Settings













Header	Factory Setting	Description
J27 	Header 2 pins	<ul style="list-style-type: none"> ■ J27.1: B3 inverting input (test point). ■ J27.2: GND.
J26 	4 Pins terminal block	<ul style="list-style-type: none"> ■ J26.1: GND. ■ J26.2: B3 inverting input. ■ J26.3: A3 non-inverting input. ■ J26.4: GND.
J23 	Header 2 pins	<ul style="list-style-type: none"> ■ J23.1: R3 output (test point). ■ J23.2: GND.
J24 	Header 3 pins	<ul style="list-style-type: none"> ■ J24.1: V_{CC} ■ J24.2: R3 output. ■ J24.3: GND.
J20 	Header 2 pins	<ul style="list-style-type: none"> ■ J20.1: R4 output (test point). ■ J20.2: GND.
J21 	Header 3 pins	<ul style="list-style-type: none"> ■ J21.1: V_{CC} ■ J21.2: R4 output. ■ J21.3: GND
J19 	Header 2 pins	<ul style="list-style-type: none"> ■ J17.1: B4 inverting input (test point). ■ J17.2: GND.
J19 	Header 2 pins	<ul style="list-style-type: none"> ■ J19.1: A4 non-inverting input (test point). ■ J19.2: GND.

Table 5: EVK Header Pin Description and Default Settings

Header	Factory Setting	Description
J18 	4 Pins terminal block	<ul style="list-style-type: none"> ■ J18.1: GND. ■ J18.2: A4 non-inverting input. ■ J18.3: B4 inverting input. ■ J18.4: GND.
J14 	Header 1 pins	J14.1: GND
J15 	Header 1 pins	J15.1: V _{CC}
J16 	Header 1 pins	J16.1: GND

The MxL83411 device offers a global enable configuration.

All four receiver outputs are enabled simultaneously when RE = V_{CC} or REb = GND.

When RE = GND and REb = V_{CC}, all four receiver outputs are in high impedance state

Layout Recommendations

- Apply bypass capacitors of at least 100nF as close as possible to the V_{CC} terminal of device.
- Use at least two vias for V_{CC} and ground connections of the bypass capacitors to minimize the effective via-inductance.
- When possible, use V_{CC} and the ground plane to provide low-inductance traces and signal path.

For additional layout tips, refer to the *RS-232 and RS-485 PCB Layout Application Note (293AN)*.



MaxLinear, Inc.
5966 La Place Court, Suite 100
Carlsbad, CA 92008
Tel.: +1 (760) 692-0711
Fax: +1 (760) 444-8598
www.maxlinear.com

The content of this document is furnished for informational use only, is subject to change without notice, and should not be construed as a commitment by MaxLinear, Inc. MaxLinear, Inc. assumes no responsibility or liability for any errors or inaccuracies that may appear in the informational content contained in this document. Complying with all applicable copyright laws is the responsibility of the user. Without limiting the rights under copyright, no part of this document may be reproduced into, stored in, or introduced into a retrieval system, or transmitted in any form or by any means (electronic, mechanical, photocopying, recording, or otherwise), or for any purpose, without the express written permission of MaxLinear, Inc.

EXCEPT AS OTHERWISE PROVIDED EXPRESSLY IN WRITING BY MAXLINEAR, AND TO THE MAXIMUM EXTENT PERMITTED BY LAW: (A) THE MAXLINEAR PRODUCTS ARE PROVIDED ON AN "AS IS" BASIS WITHOUT REPRESENTATIONS OR WARRANTIES OF ANY KIND, INCLUDING WITHOUT LIMITATION ANY IMPLIED OR STATUTORY WARRANTIES AND ANY WARRANTIES OF MERCHANTABILITY, FITNESS FOR A PARTICULAR PURPOSE, NON-INFRINGEMENT, OR TITLE; AND (B) MAXLINEAR DOES NOT GUARANTEE THAT THE PRODUCTS WILL BE FREE OF ERRORS OR DEFECTS. MAXLINEAR PRODUCTS SHOULD NOT BE USED IN ANY EMERGENCY, SECURITY, MILITARY, LIFE-SAVING, OR OTHER CRITICAL USE CASE WHERE A FAILURE OR MALFUNCTION COULD CAUSE PERSONAL INJURY OR DEATH, OR DAMAGE TO OR LOSS OF PROPERTY. USERS ASSUME ALL RISK FOR USING THE MAXLINEAR PRODUCTS IN SUCH USE CASE. CUSTOMERS AND USERS ARE SOLELY RESPONSIBLE FOR USING THEIR OWN SKILL AND JUDGMENT TO DETERMINE WHETHER MAXLINEAR PRODUCTS ARE SUITABLE FOR THE INTENDED USE CASE.

MaxLinear, Inc. may have patents, patent applications, trademarks, copyrights, or other intellectual property rights covering subject matter in this document. Except as expressly provided in any written license agreement from MaxLinear, Inc., the furnishing of this document does not give you any license to these patents, trademarks, copyrights, or other intellectual property.

MaxLinear, the MaxLinear logo, any other MaxLinear trademarks (including but not limited to MxL, Full-Spectrum Capture, FSC, AirPHY, Puma, AnyWAN, VectorBoost, MXL WARE, and Panther), and the MaxLinear logo on the products sold are all property of MaxLinear, Inc. or one of MaxLinear's subsidiaries in the U.S.A. and other countries. All rights reserved.

All third-party products, company names and logos are trademarks™ or registered® trademarks and remain the property of their respective holders/owners. Use of such marks does not imply any affiliation with, sponsorship or endorsement by the owners/holders of such trademarks. All references by MaxLinear to third party trademarks are intended to constitute nominative fair use under applicable trademark laws.

The URLs provided are for informational purposes only; they do not constitute an endorsement or an approval by MaxLinear of any of the products or services of the corporation or organization or individual. MaxLinear bears no responsibility for the accuracy, legality or content of the external site or for that of subsequent links. Contact the external site for answers to questions regarding its content.