



This document has been made public and no NDA is needed.

The "Confidential" statement in the attached material is no longer valid and may be disregarded.

This document falls into one of these categories:

- 1. Document has MaxLinear branding**

The "MaxLinear Confidential" statement will be removed from the document upon its next revision

- 2. Document has non-MaxLinear branding**

In 2020, MaxLinear acquired the Connected Home Division business of Intel Corporation, including the former Intel® product/s referenced in the title of the attached material. The MaxLinear logo will be added to the attached material upon its next revision.

MaxLinear is now the manufacturer of this product.

Direct any questions and product support requests to your MaxLinear sales contact, [MaxLinear Sales Representative or Distributor](#), or login to your myMxL account and [create a new support ticket](#).



Corporate Headquarters:
5966 La Place Court
Suite 100
Carlsbad, CA 92008
Tel.: +1 (760) 692-0711
Fax: +1 (760) 444-8598
www.maxlinear.com

The content of this document is furnished for informational use only, is subject to change without notice, and should not be construed as a commitment by MaxLinear, Inc. MaxLinear, Inc. assumes no responsibility or liability for any errors or inaccuracies that may appear in the informational content contained in this guide. Complying with all applicable copyright laws is the responsibility of the user. Without limiting the rights under copyright, no part of this document may be reproduced into, stored in, or introduced into a retrieval system, or transmitted in any form or by any means (electronic, mechanical, photocopying, recording, or otherwise), or for any purpose, without the express written permission of MaxLinear, Inc.

MaxLinear, Inc. does not recommend the use of any of its products in life support applications where the failure or malfunction of the product can reasonably be expected to cause failure of the life support system or to significantly affect its safety or effectiveness. Products are not authorized for use in such applications unless MaxLinear, Inc. receives, in writing, assurances to its satisfaction that: (a) the risk of injury or damage has been minimized; (b) the user assumes all such risks; (c) potential liability of MaxLinear, Inc. is adequately protected under the circumstances.

MaxLinear, Inc. may have patents, patent applications, trademarks, copyrights, or other intellectual property rights covering subject matter in this document. Except as expressly provided in any written license agreement from MaxLinear, Inc., the furnishing of this document does not give you any license to these patents, trademarks, copyrights, or other intellectual property.

MaxLinear, the MaxLinear logo, and any MaxLinear trademarks, MxL, Full-Spectrum Capture, FSC, G.now, AirPHY, Puma, AnyWAN and the MaxLinear logo are all on the products sold, are all trademarks of MaxLinear, Inc. or one of MaxLinear's subsidiaries in the U.S.A. and other countries. All rights reserved. Other company trademarks and product names appearing herein are the property of their respective owners.



Ethernet Network Connection

Single Port 1G Ethernet PHY

Ethernet Network Connection GPY115 (GPY115B1VI, GPY115C0VI)

Data Sheet

MaxLinear Confidential

Revision 1.4, 2021-04-27

Reference ID 617807

Legal Notice

The content of this document is furnished for informational use only, is subject to change without notice, and should not be construed as a commitment by MaxLinear, Inc. MaxLinear, Inc. assumes no responsibility or liability for any errors or inaccuracies that may appear in the informational content contained in this guide. Complying with all applicable copyright laws is the responsibility of the user. Without limiting the rights under copyright, no part of this document may be reproduced into, stored in, or introduced into a retrieval system, or transmitted in any form or by any means (electronic, mechanical, photocopying, recording, or otherwise), or for any purpose, without the express written permission of MaxLinear, Inc.

MaxLinear, Inc. does not recommend the use of any of its products in life support applications where the failure or malfunction of the product can reasonably be expected to cause failure of the life support system or to significantly affect its safety or effectiveness. Products are not authorized for use in such applications unless MaxLinear, Inc. receives, in writing, assurances to its satisfaction that: (a) the risk of injury or damage has been minimized; (b) the user assumes all such risks; (c) potential liability of MaxLinear, Inc. is adequately protected under the circumstances.

MaxLinear, Inc. may have patents, patent applications, trademarks, copyrights, or other intellectual property rights covering subject matter in this document. Except as expressly provided in any written license agreement from MaxLinear, Inc., the furnishing of this document does not give you any license to these patents, trademarks, copyrights, or other intellectual property.

MaxLinear, the MaxLinear logo, any MaxLinear trademarks (MxL, Full-Spectrum Capture, FSC, G.now, AirPHY, Puma, and AnyWAN), and the MaxLinear logo on the products sold are all property of MaxLinear, Inc. or one of MaxLinear's subsidiaries in the U.S.A. and other countries. All rights reserved.

*Other company trademarks and product names appearing herein are the property of their respective owners.

© 2021 MaxLinear, Inc. All rights reserved.

MaxLinear, Inc.
5966 La Place Court, Suite 100
Carlsbad, CA 92008
Tel.: +1 (760) 692-0711
Fax: +1 (760) 444-8598
www.maxlinear.com

Revision History

Current:	Revision 1.4, 2021-04-27
Previous:	Revision 1.3, 2020-12-22
Page	Major changes since previous revision
All	This document covers GPY115C0VI and GPY115B1VI. GPY115C0VI is an enhanced performance version of GPY115B1VI with reduced power consumption.
1	Added GPY115C0VI on Front Page.
26	Figure 4, MDIO Access Timing : Added MDIO access timing.
36	Section 3.4.6.1 Enabling SGMII Auto-negotiation Mode : Corrected SGMII auto-negotiation default setting.
39	Section 3.5.3 LED Brightness Control : Updated LED Brightness Control section.
81	Removed TPG Control register.
120	Table 23, Registers Overview : Updated ANEG_MGBT_AN_CTRL Reset value.
133	ANEG_MGBT_AN_CTRL, MULTI GBT AN Control Register (Register 7.32) : Updated Reset value.
139	VSPEC1_LED0, PULSE : Updated Pulsing Configuration.
140	VSPEC1_LED1, PULSE : Updated Pulsing Configuration.
141	VSPEC1_LED2, PULSE : Updated Pulsing Configuration.
143	VSPEC1_LED3, PULSE : Updated Pulsing Configuration.
149	Updated conversion formula in temperature code.
160	Table 28, Typical Power Consumption (GPY115C0VI) : Added typical power consumption for GPY115C0VI.
161	Table 30, Maximum Power Consumption (GPY115C0VI) : Added maximum power consumption for GPY115C0VI.
182	Figure 31, Example of Chip Marking : Updated Chip Marking pattern.
182	Table 53, Chip Marking Pattern : Updated Chip Marking Pattern information.
182	Table 54, Product Naming (GPY115C0VI) : Added Product Naming for GPY115C0VI, including engineering sample information.

Table of Contents

	Table of Contents	4
	List of Figures	7
	List of Tables	8
1	Product Overview	10
1.1	Features	11
1.2	Block Diagram	13
2	External Signals	14
2.1	Overview	14
2.2	External Signal Description	15
2.2.1	Pin Diagram	15
2.2.2	Abbreviations	16
2.2.3	Input/Output Signals	17
2.2.3.1	Ethernet Media Interface	17
2.2.3.2	SGMII Interface	17
2.2.3.3	LED/JTAG/GPIO Interface	18
2.2.3.4	Management Interfaces	19
2.2.3.5	Miscellaneous Signals	20
2.2.3.6	Power Supply	21
3	Functional Description	24
3.1	Power Supply, Clock and Reset	24
3.1.1	Power Supply	24
3.1.2	Clock Generation	24
3.1.3	Reset Generation	24
3.1.4	Power-On Sequence	24
3.1.5	Configuration by Pin Strapping	24
3.2	Configuration via MDIO Management Interface	26
3.3	Ethernet PHY Interface	26
3.3.1	Twisted Pair Interface	26
3.3.2	Transformerless Ethernet (TLE)	27
3.3.3	Auto-negotiation (ANEG)	27
3.3.4	Auto-downspeed	28
3.3.5	Polarity Reversal Correction	28
3.3.6	Auto-Crossover Correction	28
3.3.7	RJ45 Tap Up or Tap Down Configuration	30
3.3.8	Wake-on-LAN (WoL)	31
3.4	SGMII Interface	32
3.4.1	SGMII Control and Status Registers	32
3.4.2	SGMII Configuration at Power Up	34
3.4.3	SGMII PHY Side Setup According to TPI Setup	34
3.4.4	SGMII MAC Side Setup by MAC SoC	34
3.4.5	SGMII Link Monitoring by MAC SoC	35
3.4.5.1	Actions on TPI Link Down / Link Up Status Change	35
3.4.5.2	New TPI Link Up at Same Speed	35
3.4.6	Auto-negotiation Modes Supported by SGMII	36
3.4.6.1	Enabling SGMII Auto-negotiation Mode	36
3.5	LED Interface	37
3.5.1	LED	37

3.5.2	LED Configuration	37
3.5.3	LED Brightness Control	39
3.6	Precision Time Protocol (PTP) Feature	39
3.6.1	PTP Feature Purpose	39
3.6.2	PTP Feature Configuration	40
3.7	Pulse Per Second (PPS) Feature	41
3.7.1	PPS Feature Purpose	41
3.7.2	PPS Feature Configuration	41
3.8	Synchronous Ethernet (Sync-E) Feature	41
3.8.1	Sync-E Feature Purpose	41
3.8.2	Sync-E Feature Configuration	41
3.9	Smart-AZ Feature	41
3.10	MACsec Feature	42
3.10.1	MACsec Purpose	42
3.10.2	MACsec Feature Usage	42
3.10.3	MACsec Engine Control API Executed on MAC SoC	43
3.11	Power Management	44
3.11.1	Power States	44
3.11.2	RESET Power Up	44
3.11.3	SLEEP State	44
3.11.4	SCAN State	45
3.11.5	PING State	45
3.11.6	ULP State	45
3.11.7	NORMAL State	48
3.11.8	Low-Power IDLE State: Energy-Efficient Ethernet	48
3.12	Field Firmware Upgrade (FFU)	48
4	MDIO and MMD Register Interface Description	50
4.1	Definitions	50
4.2	Register Naming and Numbering	51
4.2.1	Register Numbering	51
4.2.2	Register Naming	51
4.2.3	Examples	51
4.3	MMD Devices Present in GPY115	52
4.4	Responsibilities of the STA	52
4.5	MDIO Access Protocols to Read / Write Registers	52
5	MDIO Registers Detailed Description	53
5.1	Standard Management Registers	54
5.1.1	Standard Management Registers	54
5.2	GPY-specific Management Registers	71
5.2.1	GPY-specific Management Registers	71
6	MMD Registers Detailed Description	85
6.1	Standard PMAPMD Registers for MMD=0x01	86
6.1.1	Standard PMAPMD Registers for MMD=0x01	87
6.2	Standard PCS Registers for MMD=0x03	108
6.2.1	Standard PCS Registers for MMD=0x03	108
6.3	Standard Auto-Negotiation Registers for MMD=0x07	120
6.3.1	Standard Auto-Negotiation Registers for MMD=0x07	121
6.4	Vendor Specific 1 Device for MMD=0x1E	138
6.4.1	Vendor Specific 1 Device for MMD=0x1E	138
6.5	Vendor Specific 2 Device for MMD=0x1F	153

Table of Contents

6.5.1	Vendor Specific 2 Device for MMD=0x1F	153
7	Electrical Characteristics	157
7.1	Absolute Maximum Ratings	157
7.2	Operating Range	159
7.3	Chip Power Consumption	160
7.4	DC Characteristics	162
7.4.1	Digital Interfaces	162
7.4.2	Twisted Pair Interface	162
7.4.3	Built-in Temperature Sensor	163
7.5	AC Characteristics	164
7.5.1	Power Up and Power Down Sequence with External Supply of V_{LOW} Domain	164
7.5.2	Power Up and Power Down Sequence in Internal DCDC SVR Configuration	166
7.5.3	Power Supply Rail Requirements	168
7.5.4	MDIO Interface	169
7.5.5	SGMII Interface	170
7.5.5.1	Transmit Timing Characteristics	170
7.5.5.2	Receive Timing Characteristics	171
7.5.6	Serial Peripheral Interface (SPI)	172
7.5.7	JTAG Interface	173
7.5.8	Crystal Specification	174
7.6	External Circuitry	175
7.6.1	Twisted-Pair Common-Mode Rejection and Termination Circuitry	175
7.6.2	Transformer (Magnetics)	176
7.6.3	RJ45 Plug	177
7.6.4	Calibration Resistors	177
7.7	Power Supply	177
7.7.1	Power Supply Using Integrated DC/DC SVR Converter	177
7.7.2	Power Supply without using Integrated DC/DC Converter	179
8	Package Outline	180
8.1	Chip Identification and Ordering Information	182
	Terminology	183
	References	186

List of Figures

Figure 1	Ethernet Network Connection GPY115 Block Diagram	13
Figure 2	Ethernet Network Connection GPY115 External Signals Overview	14
Figure 3	Pin Diagram for PG-VQFN-56 (Top View)	15
Figure 4	MDIO Access Timing	26
Figure 5	Twisted-Pair Interface of GPY115 Including Transformer and RJ45 Plug	27
Figure 6	External Circuitry for the Transformerless Ethernet Application	27
Figure 7	RJ45 Tap Up or Tap Down Configuration	30
Figure 8	Block Diagram of WoL Application	31
Figure 9	GPY115 SGMII Configuration and Status Registers	33
Figure 10	LED Connection Options to Ground or Power Supply	37
Figure 11	Connection of a Dual Color LED and Configuring Pin Strap Value	38
Figure 12	Connection of a Single Color LED and Configuring Pin Strap Value	38
Figure 13	LED Brightness Control By Controlling LED Output Enable/Disable	39
Figure 14	State Diagram for Power Down State Management	44
Figure 15	ULP Sequence	46
Figure 16	EEE Low-Power Idle Sequence	48
Figure 17	Timing Diagram for the Reset Sequence (External supply of V_{LOW} domain)	164
Figure 18	Timing Diagram for the Reset Sequence (External supply of V_{LOW} domain) when $V_{DDP}=1.8\text{ V}$	165
Figure 19	Timing Diagram for the Reset Sequence (Internal DCDC SVR Configuration)	166
Figure 20	Timing Diagram for the Reset Sequence (Internal DCDC SVR Configuration) when $V_{DDP}=1.8\text{ V}$	167
Figure 21	Timing Diagram for the MDIO Interface	169
Figure 22	Transmit Timing Diagram of the SGMII (shows alternating data sequence)	170
Figure 23	Receive Timing Diagram of the SGMII (alternating data input sequence)	171
Figure 24	SPI Master Interface Timing	172
Figure 25	JTAG Interface Timing	173
Figure 26	Twisted Pair Common-Mode Rejection and Termination Circuitry	175
Figure 27	Schematic of an Ethernet Transformer Device	176
Figure 28	External Circuitry Using the Integrated DC/DC Converter	178
Figure 29	External Circuitry without using the Integrated DC/DC Converter	179
Figure 30	PG-VQFN-56 7 mm x 7 mm Package Outline	181
Figure 31	Example of Chip Marking	182

List of Tables

Table 1	Abbreviations for Pin Type	16
Table 2	Abbreviations for Buffer Type	16
Table 3	Ethernet Media Interface Signals	17
Table 4	SGMII Interface Signals	17
Table 5	LED Interface Signals	18
Table 6	Management Interface Signals	19
Table 7	Miscellaneous Signals	20
Table 8	Power Supply Pins	21
Table 9	Device Ground	23
Table 10	Pin Names used for Pin Strapping	25
Table 11	Pin Strapping Configuration Description	25
Table 12	Supported Twisted Pair Mappings on a CAT5 or Better Cable	29
Table 13	Programming Sequence for the Wake-on-LAN Functionality	31
Table 14	ULP State Entry and Exit Sequence	46
Table 15	ULP Persistent Registers	47
Table 16	MDIO / MMD Devices Present in GPY115	52
Table 17	Register Access Type	53
Table 18	Registers Overview	54
Table 19	Registers Overview	71
Table 20	Register Access Type	85
Table 21	Registers Overview	86
Table 22	Registers Overview	108
Table 23	Registers Overview	120
Table 24	Registers Overview	138
Table 25	Registers Overview	153
Table 26	Absolute Maximum Ratings	157
Table 27	Operating Range	159
Table 28	Typical Power Consumption (GPY115C0VI)	160
Table 29	Typical Power Consumption (GPY115B1VI)	160
Table 30	Maximum Power Consumption (GPY115C0VI)	161
Table 31	Maximum Power Consumption (GPY115B1VI)	161
Table 32	DC Characteristics of the GPIO Interfaces (VDDP = 3.3 V)	162
Table 33	DC Characteristics of the GPIO Interfaces (VDDP = 1.8 V)	162
Table 34	Temperature Sensor Characteristics	163
Table 35	Power Supply Timings (External supply of V _{LOW} domain)	165
Table 36	Power Supply Timings (Internal DCDC SVR Configuration)	167
Table 37	AC Characteristics of the Power Supply	168
Table 38	Timing Characteristics of the MDIO Interface	169
Table 39	Transmit Timing Characteristics of the SGMII	170
Table 40	Receive Timing Characteristics of the SGMII	171
Table 41	SPI Interface Timing Parameters	172
Table 42	JTAG Interface Clock	173
Table 43	JTAG Timing	173
Table 44	Specification of the Crystal	174
Table 45	Electrical Characteristics for Common-Mode Rejection and Termination Circuitry	175
Table 46	Electrical Characteristics for Supported Transformers (Magnetics)	176
Table 47	Electrical Characteristics for Supported RJ45 Plugs	177
Table 48	Calibration Resistors Values	177
Table 49	External Component Values for DC/DC Converter	178

List of Tables

Table 50	JEDEC Thermal Resistance Package Parameter - Still air conditions	180
Table 51	JEDEC Thermal Resistance Package Parameter - With Thermal Solution Environment	180
Table 52	JEDEC Thermal Resistance Package Parameter - Compact 2-R Model Network	180
Table 53	Chip Marking Pattern	182
Table 54	Product Naming (GPY115C0VI)	182
Table 55	Product Naming (GPY115B1VI)	182

1 Product Overview

The Ethernet Network Connection GPY115 is a low power Ethernet PHY transceiver integrated circuit. It offers a cost-optimized solution that is well-suited for routers, switches, and home gateways. It performs the data transmission on an Ethernet twisted pair copper cable of category Cat5e or higher. GPY115 supports the following data rates: 1000, 100, and 10 Mbit/s.

In terms of the Open System Interconnection (OSI) model, the GPY115 implements a layer 1 physical media access device. It can be connected to another chip implementing a layer 2 MAC via a serial SGMII data interface.

On the Ethernet twisted pair interface, the GPY115 is compliant with the following standards from IEEE 802.3 referenced in [2]: 1000BASE-T (IEEE802.3 Clause 40), 100BASE-TX (IEEE 802.3 Clause 25) and 10BASE-T (IEEE 802.3 Clause 14). This interface supports the Energy-Efficient Ethernet feature to reduce idle mode power consumption. Power saving at the system level is also possible with the Wake-on-LAN feature. A low-EMI line driver with integrated termination facilitates the PCB design.

On the SGMII interface, connecting to another chip implementing a MAC layer, the GPY115 supports the following standards: IEEE802.3 Clause 36 and 27 [2]. This interface also operates at data rates: 1000, 100, and 10 Mbit/s.

The GPY115 supports the Precision Time Protocol (PTP) and Synchronous Ethernet (Sync-E).

The GPY115 integrates a MAC security engine (MACsec) that can be used to perform wire-speed point to point encryption when the MAC SoC does not support the feature in its MAC layer.

The GPY115 supports a standard MDIO management interface as defined in IEEE 802.3 Clause 22 and Clause 45 [2]. The MDIO serial interface can operate with a clock running up to 25 MHz. It allows a management entity (the external chip implementing the MAC) to access standard MDIO / MMD registers to control the GPY115 behavior, or to read the link status. In addition, two vendor specific register banks (VSPEC1 and VSPEC2) allow GPY115 specific configuration of LED, SGMII, and Wake-on-LAN features. The MDIO and MMD registers are documented in [Chapter 5](#). The GPY115 is also configurable via pin strapping.

The GPY115 can drive up to four LEDs. Each LED is independently programmable to indicate the link speed, and traffic activities. Several indication schemes can be selected.

A DC/DC converter is integrated within the GPY115. A single external power supply of 3.3 V is sufficient to power the chip, with the internal DC/DC converter generating 1.0 V to supply the low voltage domains. External supply of both 3.3 V and 1.0 V is also an option.

The GPY115 uses a single row package (type PG-VQFN-56, size 7 mm x 7 mm).

1.1 Features

This chapter provides an overview of the features supported by the GPY115:

Communication Interfaces

- The multiple speed, single-port Ethernet PHY interface to the twisted pair cable supports:
 - Ethernet modes and standards: 1000BASE-T (IEEE 802.3), 100BASE-TX (IEEE 802.3) and 10BASE-T (IEEE 802.3)
 - Ethernet twisted pair copper cable of category CAT5 or higher
 - Low EMI voltage mode line driver with integrated termination resistors
 - Transformerless Ethernet for backplane applications
 - Auto-negotiation (ANEG) with extended next page support
 - Auto-MDIX and polarity correction
 - Auto-downspeed (ADS)
 - Energy-Efficient Ethernet (EEE) and power down mode
 - Wake-on-LAN (WoL)
 - Power-over-Ethernet (POE)
 - Precise time stamping, implementing standard IEEE 1588v2
 - SPI interface supports Secure Field Firmware Upgrade (FFU) of the flash memory
- The SGMII SerDes interface supports:
 - 1000BASE-X IEEE 802.3 Clause 36 and 37 [\[2\]](#)
 - Cisco* Serial-GMII Specification [\[3\]](#) operating at 1.25 Gbaud/s
 - Clock and Data Recovery (CDR)
 - SGMII power saving when a Low Power Indication (LPI) is active
- The management interface supports the communication between the Station Management (acronym “STA” per IEEE 802.3) and the GPY115 using:
 - An MDIO slave interface that provides access to the standard registers in the MMD as described in IEEE 802.3 Clause 22 and Clause 45 [\[2\]](#) and listed in [Chapter 5](#)
 - An MDIO interface clock of up to 25 MHz
 - 3 MDIO message frame types as described in IEEE 802.3: Clause 22, Clause 22 Extended, Clause 45 [\[2\]](#)
- The LED interface supports:
 - Up to 4 LEDs
 - Single and dual color LEDs
 - Connection of LED to ground or 3.3 V
 - Several LED indication schemes (link/activity, link speed)
 - Configuration of LED indication via MDIO registers
 - Control of LED brightness via software driver API
 - Alternative configuration of LED pins as GPIO for custom indication
- Supports two external interrupts EXINT0 and EXINT1:
 - Configurable as input from, or output to an external controller

Clocking, Timing and Time Stamping Features

- 25 MHz crystal operation
- Supports Synchronous Ethernet (Sync-E), implementing standard ITU-T G.8262/Y.1362
- Supports precise time stamping (PTP) according to standard IEEE 1588v2
- Supports two general purpose clock pins GPC1 and GPC2 shared with GPIO for several usage options, configurable by GPY API:
 - to input or output the Synchronous Ethernet reference clock Sync-E: 2.048 MHz, 1.544 MHz
 - to input or output the precise time stamping signals (PTP)
 - to output the pulse per second signal (PPS)

Test Features

- JTAG boundary scan
- Cable diagnostics: cable open/short detection and cable length estimation
- UART

MACsec Security Feature

- MACsec Engine (compliant with IEEE 802.1AE, IEEE 802.1AEbn and IEEE 802.1AEbw MAC security standards)
- MACsec Engine is controlled by an API executed on the associated MAC SoC through the slave MDIO interface (GPYAPI)

Power Supply

- Single 3.3 V power supply, when using the integrated DC/DC converter to generate the 1.0 V power supply rail
- If the internal integrated DC/DC converter is not used, an additional 1.0 V supply must be provided externally
- Ultra low power mode to reduce the energy consumption down to 10 mW when the Ethernet cable is unplugged, with automatic wake-up upon energy detection from cable

1.2 Block Diagram

Figure 2 shows the block diagram of the GPY115. The main interfaces are:

- Data interface to a MAC processor, using SGMII
- Slave control interface driven by a MAC processor, using MDIO slave
- Interrupt signal MDINT allowing the GPY115 to notify the MAC processor about a change of status
- LED control
- Twisted pair interface

The GPY115 product variant supports the MACsec block, which performs encryption and decryption of the MAC frames as indicated in Figure 2.

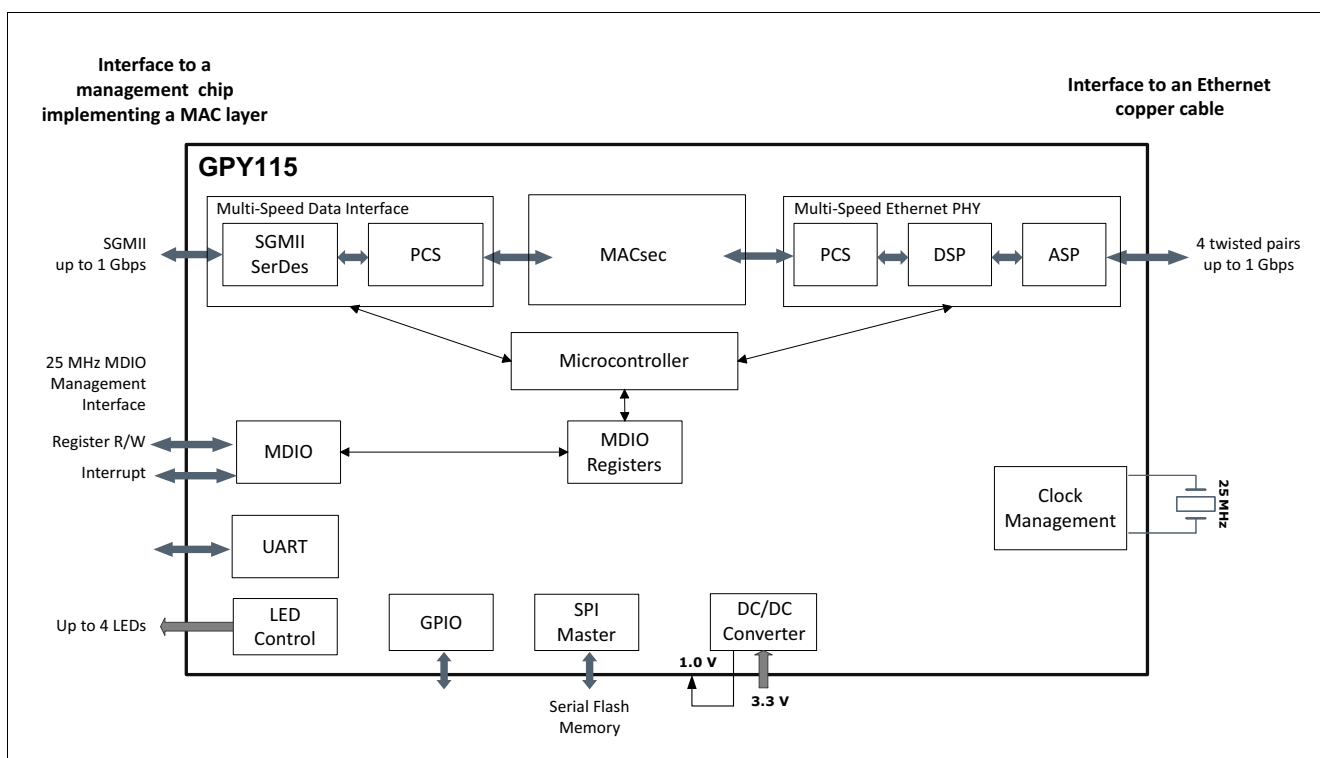

Figure 1 Ethernet Network Connection GPY115 Block Diagram

2 External Signals

This chapter describes the signal mapping to the package.

2.1 Overview

Figure 3 provides an overview of the external interfaces of the GPY115.

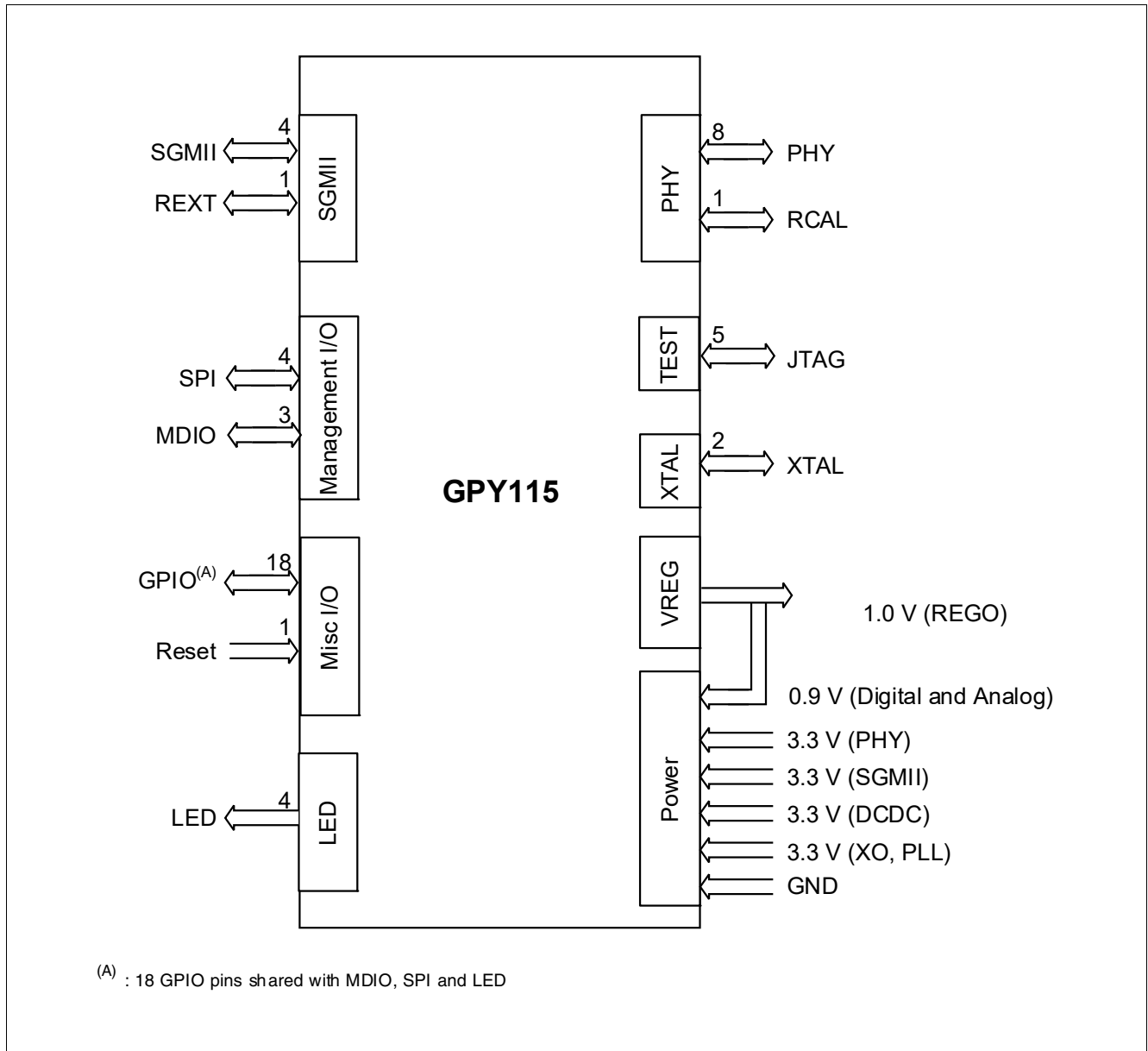

Figure 2 Ethernet Network Connection GPY115 External Signals Overview

2.2 External Signal Description

This chapter provides the pin diagram, abbreviations for pin types and buffer types, as well as tables describing the input and output signals.

2.2.1 Pin Diagram

The pin layout of the package is shown in [Figure 3](#).

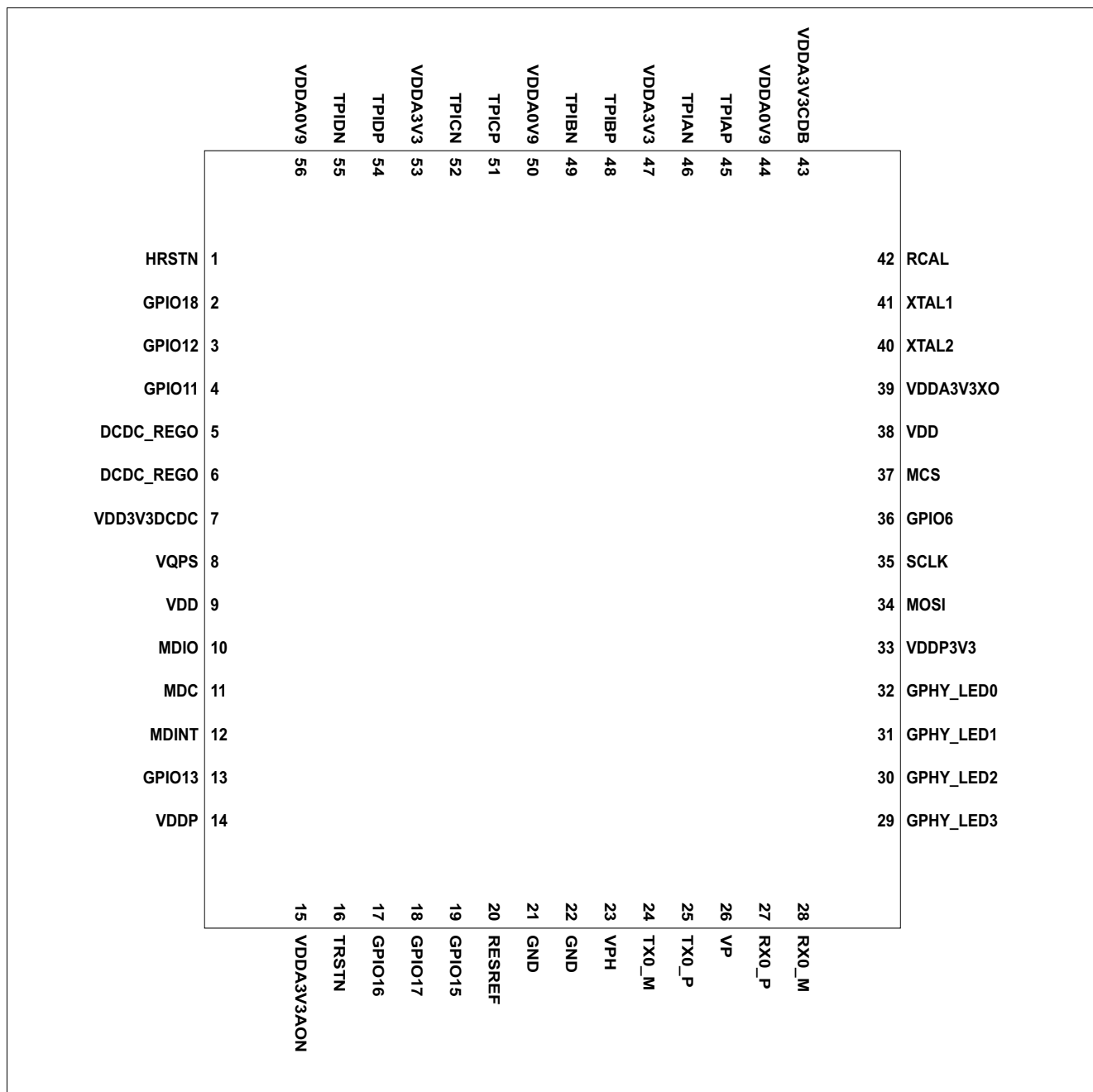

Figure 3 Pin Diagram for PG-VQFN-56 (Top View)

2.2.2 Abbreviations

Abbreviations that are used in the signal tables are summarized in [Table 1](#) and [Table 2](#).

Table 1 Abbreviations for Pin Type

Abbreviations	Description
I	Input only, digital levels
O	Output only, digital levels
I/O	Bidirectional input/output signal, digital levels
Prg	Bidirectional pad, programmable to operate either as input or output, digital levels
AI	Input only, analog levels
AO	Output only, analog levels
AI/O	Bidirectional, analog levels
PWR	Power
GND	Ground

Table 2 Abbreviations for Buffer Type

Abbreviations	Description
A	Analog characteristics, see the AC/DC specification for more detail
GND	Ground
Prg	Programmable with an alternate function

2.2.3 Input/Output Signals

A detailed description of all the pins is given in [Table 3](#) to [Table 8](#).

In [Table 5](#) to [Table 8](#), the signal names highlighted in bold are the same as the pin name. The signal names that are not in bold indicate alternate functions.

2.2.3.1 Ethernet Media Interface

Table 3 Ethernet Media Interface Signals

Pin No.	Name	Pin Type	Buffer Type	Function
Ethernet Port Ethernet Media Interface				
45	TPIAP	AI/AO	A	Twisted Pair Transmit/Receive Positive/Negative
46	TPIAN	AI/AO	A	
48	TPIBP	AI/AO	A	
49	TPIBN	AI/AO	A	
51	TPICP	AI/AO	A	
52	TPICN	AI/AO	A	
54	TPIDP	AI/AO	A	
55	TPIDN	AI/AO	A	
Ethernet Port Calibration				
42	RCAL	AI/AO	A	Calibration of GPHY Ethernet Port Using a high precision resistor.

2.2.3.2 SGMII Interface

Table 4 SGMII Interface Signals

Pin No.	Name	Pin Type	Buffer Type	Function
28	RX0_M	AI	A	Differential SGMII Data Input Pair These are the negative and positive signals respectively of the differential input pair of the SGMII SerDes interface. Due to the integrated CDR, no external transmission of source-synchronous clock is required for SGMII. These pins must be AC coupled.
27	RX0_P	AI	A	
25	TX0_P	AO	A	Differential SGMII Data Output Pair These are the negative and positive signals respectively of the differential output pair of the SGMII SerDes interface.
24	TX0_M	AO	A	
20	RESREF	AI/O	A	Pad to Connect External Tuning Resistor
21	GND	AI	GND	Connect to Ground
22	GND	AI	GND	Connect to Ground

2.2.3.3 LED/JTAG/GPIO Interface

The LED interface allows external LEDs to be connected to indicate the status of the Ethernet PHY interfaces. Single and dual color LEDs are supported.

Table 5 LED Interface Signals

Pin No.	Name	Pin Type	Buffer Type	Function
LED Signals				
32	GPHY_LED0	O		GPHY LED0 LED control output, freely configurable, drives single color or dual color LEDs.
31	GPHY_LED1	O		GPHY LED1 LED control output, freely configurable, drives single color or dual color LEDs.
30	GPHY_LED2	O		GPHY LED2 LED control output, freely configurable, drives single color or dual color LEDs.
29	GPHY_LED3	I/O	Prg	GPHY LED3 LED control output, freely configurable, drives single color or dual color LEDs. This pin is also used for the brightness control switch input.
	TCK	I	PU	JTAG Test Clock The signals TDI, TDO and TMS are synchronous subject to this JTAG test clock.
16	TRSTN	I	PD	JTAG Test Reset The signal TRSTN must be pulled-down to ground. The JTAG is only used in production for boundary scan.
19	GPIO15	Prg	Prg	General Purpose IO 15 Configurable as input or output. The output characteristic can be selected to be open drain or push-pull.
	TDI	I	PU	JTAG Serial Test Data Input
17	GPIO16	Prg	Prg	General Purpose IO 16 Configurable as input or output. The output characteristic can be selected to be open drain or push-pull.
	TMS	I	PU	JTAG Test Mode Select
18	GPIO17	Prg	Prg	General Purpose IO 17 Configurable as input or output. The output characteristic can be selected to be open drain or push-pull.
	TDO	O		JTAG Serial Test Data Output JTAG test data output.

2.2.3.4 Management Interfaces

Two types of serial management interface are provided:

- SPI master interface
- MDIO slave interface

Table 6 Management Interface Signals

Pin No.	Name	Pin Type	Buffer Type	Function
MDIO Slave Interface				
4	GPIO11	Prg	Prg	General Purpose IO 11 Configurable as input or output. The output characteristic can be selected to be open drain or push-pull.
	GPC1	Prg		General Purpose Clock 1 General purpose clock for Synchronous Ethernet or external devices. Either input or output mode can be selected.
11	MDC	I	Prg	MDIO Slave Clock The external controller host (also called “STA” in IEEE standard) acts as clock master and provides the serial clock of up to 25 MHz on this input.
10	MDIO	I/O	Prg	MDIO Slave Data Input/Output The external controller host (also called “STA” in IEEE standard) uses this signal to address internal registers and to transfer data to and from the internal registers.
SPI Master Interface				
36	GPIO6	Prg	Prg	General Purpose IO 6 Configurable as input or output. The output characteristic can be selected to be open drain or push-pull.
	MISO	I		SPI Data Input SPI interface data input.
34	MOSI	O	Prg	SPI Data Output SPI interface data output.
35	SCLK	O	Prg	SPI Clock SPI interface clock.
37	MCS	O	Prg	SPI Chip Select SPI interface chip select. Active low signal.

2.2.3.5 Miscellaneous Signals

Table 7 Miscellaneous Signals

Pin No.	Name	Pin Type	Buffer Type	Function
Reset and Clocking				
41	XTAL1	AI	A	Crystal: Oscillator Input A crystal must be connected between XTAL1 and XTAL2. Additional load capacitances must also tie both pins to GND.
	CLK	I		Clock: Clock Input The clock must have a frequency accuracy of ± 50 ppm.
40	XTAL2	AO	A	Crystal: Oscillator Output A crystal must be connected between XTAL1 and XTAL2. Additional load capacitances must also tie both pins to GND.
13	GPIO13	Prg	Prg	General Purpose IO 13 Configurable as input or output. The output characteristic can be selected to be open drain or push-pull.
	EXINT0			External Interrupt 0 This is an interrupt signal to or from an external host. Configurable as input or output. This is not used in the standard application.
12	GPIO14	Prg	Prg	General Purpose IO 14 Configurable as input or output.
	EXINT1			External Interrupt 1 This is an interrupt signal to or from an external host. Configurable as input or output. This is not used in the standard application.
	MDINT	O		MDIO Interrupt The MDINT signal is used to send an interrupt to an external MAC SoC acting as station manager (STA). The STA can program its sensitivity to specific events using the PHY_IMASK register. The MDINT event is then raised when the event occurs using the polarity programmed by pin strap. The STA can read which type of event occurred in the PHY_ISTAT register. Upon read of PHY_ISTAT by the STA, the MDINT is deasserted by the GPY115. Refer to Figure 9 for further details.
3	GPIO12	Prg	Prg	General Purpose IO 12 Configurable as input or output. The output characteristic can be selected to be open drain or push-pull.
	GPC2	Prg		General Purpose Clock 2 General purpose clock for Synchronous Ethernet or external devices. Either input or output mode can be selected.

Table 7 Miscellaneous Signals (cont'd)

Pin No.	Name	Pin Type	Buffer Type	Function
2	GPIO18	Prg	Prg	General Purpose IO 18 Configurable as input or output. The output characteristic can be selected to be open drain or push-pull.
1	HRSTN	I	PU	Hardware Reset Asynchronous active low device reset. If the internal Power-on-Reset (POR) circuit is used to trigger the device power up, this signal can be left unconnected.

2.2.3.6 Power Supply

This section specifies the power supply pins. They are categorized in 2 supply groups V_{HIGH} (3.3 V) and V_{LOW} (1.0 V). The V_{LOW} domain can either be supplied externally, or self-generated by the internal DC/DC SVR converter, which converts the VDD3V3DCDC 3.3 V supply into DCDC_REGO output. In the external supply configuration, the DCDC_REGO output pins are non connected (NC). In the internal DC/DC SVR converter configuration, the DCDC_REGO output pins are connected back to the V_{LOW} supply inputs.

Table 8 Power Supply Pins

Pin No.	Name	Pin Type	Buffer Type	Function
47, 53	VDDA3V3	PWR		High Voltage Domain Supply V_{HIGH} These are the input power pins for the analog front end in the high voltage domain. They have to be supplied with a nominal voltage of $V_{DDA3V3} = 3.3$ V.
44, 50, 56	VDDA0V9	PWR		Low Voltage Domain Supply V_{LOW} These are the input power supply pins for the low voltage domain. They supply mixed signal blocks in the analog front end and the clock distribution block of the Gigabit Ethernet PHY. These pins have to be supplied with a nominal voltage of $V_{DDA0V9} = 1.0$ V. When the internal DC/DC SVR converter is used, they have to be connected to the output of the converter DCDC_REGO.
39	VDDA3V3XO	PWR		XO Pad Voltage Domain Supply V_{HIGH} This is the input power supply pin for the internal PLL and the internal crystal oscillator (XO). This pin has to be supplied with a nominal voltage of $V_{DDA3V3} = 3.3$ V.
43	VDDA3V3CDB	PWR		CDB High Voltage Domain Supply V_{HIGH} This is the input power supply pin for the internal clock distribution block (CDB). This pin has to be supplied with a nominal voltage of $V_{DDA3V3} = 3.3$ V.
15	VDDA3V3AON	PWR		AON High Voltage Domain Supply V_{HIGH} This is the input power supply pin for the Always On Domain (AON). This pin has to be supplied with a nominal voltage of $V_{DDA3V3} = 3.3$ V.

Table 8 Power Supply Pins

Pin No.	Name	Pin Type	Buffer Type	Function
26	VP	PWR		SGMII Low Voltage Domain Supply V_{LOW} This is the pin for the low voltage domain of the SGMII interface. It supplies mixed signal blocks in the SGMII interface. This pin has to be supplied with a nominal voltage of $V_P = 1.0$ V. When the internal DC/DC SVR converter is used, these pins have to be connected to the output of the converter DCDC_REGO.
23	VPH	PWR		SGMII High Voltage Domain Supply V_{HIGH} This is the pin for the high voltage domain of the SGMII interface. It supplies mixed signal blocks in the PHY of the SGMII interface. This pin has to be supplied with a nominal voltage of $V_{PH} = 3.3$ V.
14	VDDP	PWR		Configurable MDIO Pad Voltage Domain Supply This is the group of supply pins for the MDIO pins group (pin 10 to 13). This group can be configured in 1.8 V or 3.3 V operation, depending on the option selected by pin strap on pin 19 (PS_MDIO_VOLTAGE). When PS_MDIO_VOLTAGE is LOW, this pin has to be supplied with a nominal voltage of $V_{DDP} = 1.8$ V. When PS_MDIO_VOLTAGE is HIGH, this pin has to be supplied with a nominal voltage of $V_{DDP} = 3.3$ V. An internal Pull up on pin 19 drives the pin 19 configuration to HIGH unless the pin is explicitly connected to ground (LOW).
33	VDDP3V3	PWR		Pad Voltage Domain Supply V_{HIGH} This is the group of supply pins for the pad supply of GPIO pins (except the MDIO group of pin which is supplied by VDDP) This pin has to be supplied with a nominal voltage of $V_{DDP3V3} = 3.3$ V.
9, 38	VDD	PWR		Core Voltage Domain Supply V_{LOW} This is the group of supply pins for the core digital voltage domain. This pin has to be supplied with a nominal voltage of $V_{DD} = 1.0$ V. When the internal DC/DC SVR converter is used, these pins have to be connected to the output of the converter DCDC_REGO.
8	VQPS	PWR		Ground This pin is not used in application mode. It must be tied to GND.
7	VDD3V3DCDC	PWR		Internal DC/DC SVR Converter Power Supply V_{HIGH} This is the supply pin for the integrated DC/DC converter. This pin has to be supplied with a nominal voltage of $V_{DDA3V3DCDC} = 3.3$ V. This pin must be connected in all supply configuration including the external V_{LOW} supply option.
5, 6	DCDC_REGO	PWR		Internal DC/DC SVR Converter Output These are the 2 pins supplying the V_{LOW} domain when the internal DC/DC SVR converter is used. In internal SVR mode this pin must be connected back to the V_{LOW} domain to self supply the chip. The connection circuitry for the internal DCDC SVR V_{LOW} supply option and the external V_{LOW} supply option are described in Figure 28 and Figure 29 .



Table 9 **Device Ground**

Pin No.	Name	Pin Type	Buffer Type	Function
EPAD ¹⁾	VSS	GND		General Device Ground

1) The EPAD is the exposed pad on the bottom of the package. This pad must be properly connected to the ground plane of the PCB.

3 Functional Description

3.1 Power Supply, Clock and Reset

This chapter provides the information required to power up the GPY115.

3.1.1 Power Supply

Two power supply options are available:

- A single external power supply of 3.3 V – with this option the internal DC/DC SVR converter generates the required 1.0 V supply.
- Two external power supplies of 3.3 V and 1.0 V – with this option, the internal DC/DC SVR converter is not used.

The detailed power supply connection requirements are documented in [Chapter 7.7](#). The differentiation between the two power supply options is done by connecting, or not the pins DCDC_REGO as details in [Figure 28](#) and [Figure 29](#).

3.1.2 Clock Generation

An external 25 MHz crystal must be connected to the GPY115. The required crystal specification is documented in [Chapter 7.5.8](#). An internal PLL circuit generates all the required internal clocks.

3.1.3 Reset Generation

The external hardware reset input (HRSTN pin) resets all the hardware modules, except the DC/DC converter:

- Driving the HRSTN pin low causes an asynchronous reset of the GPY115 system.
- Releasing the HRSTN pin high triggers the power-on sequence and boot-up procedure.

The HRSTN pin is internally connected to a weak internal pull-up resistor.

3.1.4 Power-On Sequence

The GPY115 powers on when the power is applied as shown in [Figure 19](#). The following steps are executed at power on:

- Locking of internal PLL.
- Calibration of internal voltage using a high precision external reference resistor connected to the RCAL pin.
- Reading of pin strap information, as described in [Chapter 3.1.5](#).
- Booting of the microprocessor from internal ROM.
- Auto-negotiation on the Ethernet twisted pair interface and SGMII interface using the speed capability of 1 Gbit/s full-duplex.
- Training and link up in accordance with the IEEE 802.3 [\[2\]](#) and SGMII [\[3\]](#) standards.

3.1.5 Configuration by Pin Strapping

The GPY115 device can be configured by means of pin strapping on a number of the GPIO pins. The pin strapping configurations are captured during the chip power-on sequence, until the reset initialization is complete.

The pin strap values can be set to logical high or low by connecting the corresponding pin via an external 1 kΩ resistor to either ground or 3.3 V.

The pin strap mapping is described in [Table 10](#) and [Table 11](#).

Table 10 Pin Names used for Pin Strapping

Pin Name	Pin Number	Configuration Item Description
MCS	37	PS_PHY_MADDR(0)
SCLK	35	PS_PHY_MADDR(1)
MOSI	34	PS_PHY_MADDR(2)
GPIO12	3	PS_PHY_MADDR(3)
GPIO18	2	PS_PHY_MADDR(4)
MDINT	12	PS_MINT_POL
GPIO17	18	PS_RJ45_TAP
GPIO15	19	PS_MDIO_VOLTAGE

Table 11 Pin Strapping Configuration Description

Pin Strapping Signals	Description
PS_PHY_MADDR(4:0)	MDIO PHY Address A high level means a logical 1 and low level means a logical 0.
PS_MINT_POL	MDIO Interrupt (MDINT) Polarity 0 _B HIGH MDIO Interrupt (MDINT) is active high and configured in push-pull 1 _B LOW MDIO Interrupt (MDINT) is active low and configured in open-drain
PS_MDIO_VOLTAGE	MDIO Voltage This is to specify whether the maximum voltage level used by the MDIO signals is 3.3 V or 1.8 V (pin 10 to pin 13). 0 _B LOW MDIO signals pads (pin 10 to pin 13) are supplied with 1.8 V. In this configuration the pin14 (VDDP) must be supplied with 1.8 V. 1 _B NORMAL MDIO signals pads (pin 10 to pin 13) are supplied with 3.3 V. In this configuration pin 14 (VDDP) must be supplied with 3.3 V.
PS_RJ45_TAP	RJ45 Pin Reversal 1 _B DOWN Tap down 0 _B UP Tap up

An alternative way to configure the GPY115 after the boot process is to use the MDIO interface and write into various control registers, as detailed in [Chapter 3.2](#).

3.2 Configuration via MDIO Management Interface

The external controller (Station Management, STA) can be connected to the chip's slave MDIO interface. This allows access to the MDIO and MMD registers standardized in IEEE 802.3. Thus the STA can control chip configuration and retrieve status information. The MDIO transactions can be of any of the 3 types described in IEEE 802.3 Clause 22, Clause 22 Extended, and Clause 45 [2]. The list of MDIO registers is given in [Chapter 4](#).

[Figure 4](#) shows the minimum time required for the MDIO to be available for access.

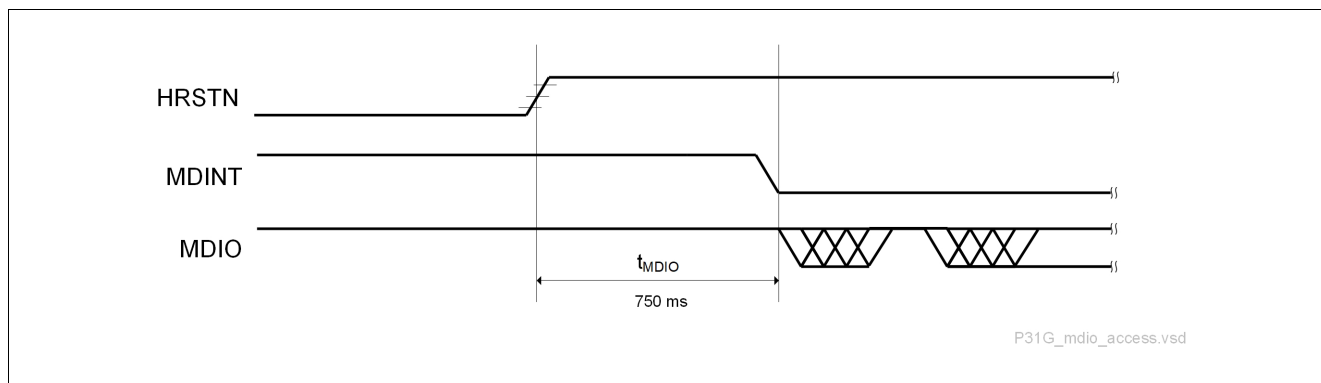

Figure 4 MDIO Access Timing

3.3 Ethernet PHY Interface

The Ethernet PHY implements the physical layer of the Ethernet standard. It supports digital signal processing (DSP) and analog signal processing (ASP) functions, to transmit data over the twisted pair cable.

3.3.1 Twisted Pair Interface

The Twisted Pair Interface (TPI) of the GPY115 is fully compliant with IEEE 802.3. To facilitate low power implementation and reduce PCB costs, the series resistors required to terminate the twisted pair link with a nominal 100 Ω are integrated in the device.

As a consequence, the TPI pins can be connected directly via a transformer to the RJ45 plug. Additional external circuitry is required for common-mode termination and rejection. A schematic of the TPI circuitry taking these components into account is shown in [Figure 5](#).

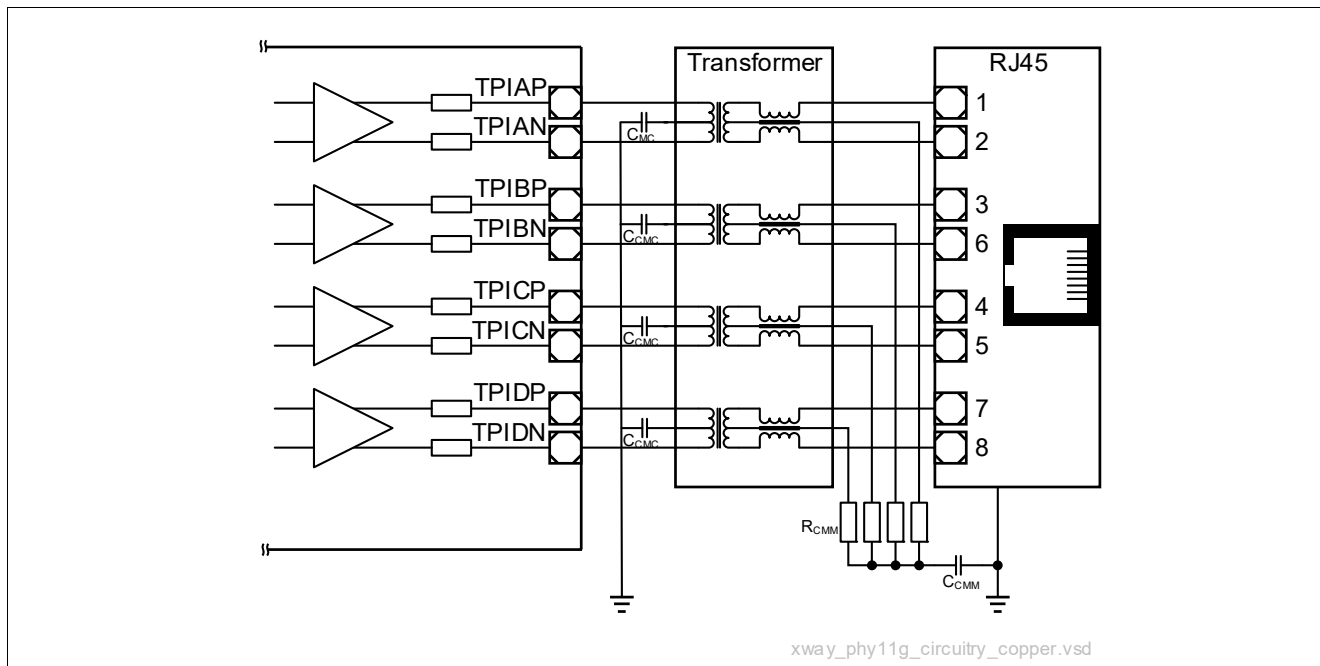

Figure 5 Twisted-Pair Interface of GPY115 Including Transformer and RJ45 Plug

3.3.2 Transformerless Ethernet (TLE)

Transformerless Ethernet (TLE) is required for backplane applications where the use of a transformer is not necessarily required to fulfill the galvanic decoupling requirements of the isolation specifications. In such applications, removing the transformer reduces both the external bill of material and the space requirements on the PCB.

As the GPY115 incorporates a voltage-mode line driver, the only stringent requirement is to use AC coupling. AC coupling can be achieved using simple SMD type series capacitors. The value of the capacitors is selected so that the high-pass characteristics correspond to an equivalent standard transformer based application (recommended $C_{coupling} = 100 \text{ nF}$). **Figure 6** shows the external circuitry for TLE.

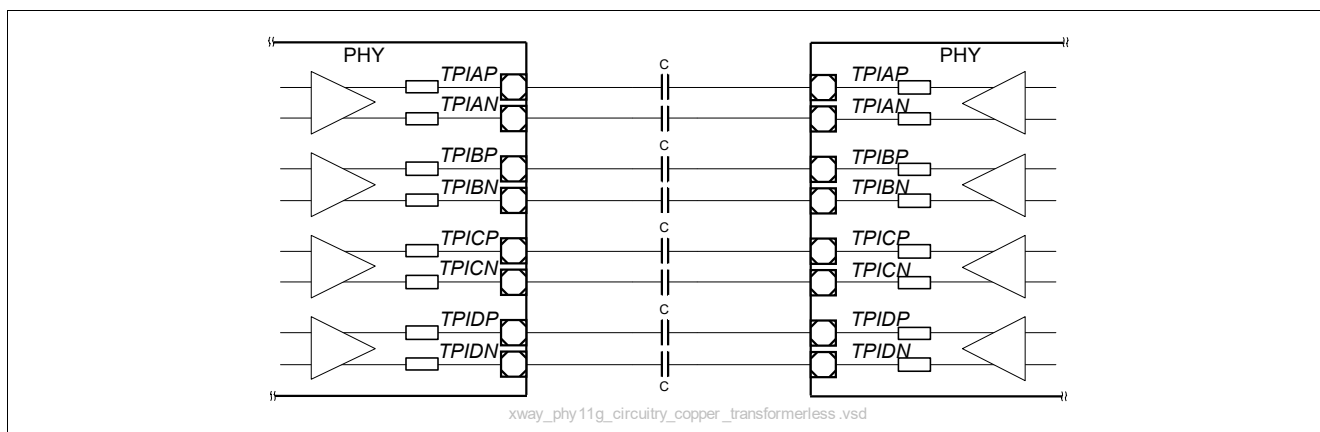

Figure 6 External Circuitry for the Transformerless Ethernet Application

3.3.3 Auto-negotiation (ANEG)

The GPY115 supports auto-negotiation (ANEG) a part of the startup procedure to exchange capability information with the link partner. ANEG is enabled at GPY115 initialization and its 1 Gbit/s speed capability is advertised.

The ANEG procedure is executed according to IEEE 802.3 Clause 28, Clause 40 [2].

If the link partner does not support ANEG, the GPY115 extracts the link speed configuration using parallel detection as described in Clause 28.

A STA connected to the MDIO interface can reprogram the GPY115 advertised capability if required. It can also disable ANEG, in which case the system configuration must ensure compatibility between link partners to link up in a compatible mode.

Attention: *STD_CTRL.DPLX takes effect only when the auto-negotiation process is disabled and the GPY TPI is not operating in loop-back mode, that is, bits STD_CTRL.ANEN and STD_CTRL.LB are set to zero. Forced Half Duplex mode (STD_CTRL.DPLX = 0b0) is supported only in 10BT and 100BT speed modes in non-MACsec operations. This field is ignored for higher speeds and MACsec operation.*

3.3.4 Auto-downspeed

The auto-downspeed (ADS) feature implements a process to decrease the operating speed of the link when the link quality or cable is insufficient. The feature ensures maximum interoperability even in harsh or inadequate cable infrastructure environments. In particular, ADS is applied during the 1000BASE-T training phase. The downspeed is necessary when the cable quality or characteristics are inadequate. For example, it is possible to advertise 1000BASE-T during ANEG when both link partners are connected via a cable that does not support the 4-pair Gigabit Ethernet mode.

The GPY115 detects such configurations to avoid repeating link up failures and clears Gigabit capability in the ANEG advertisement registers. After the resulting link down, the next ANEG procedure no longer advertises 1000BASE-T. The next link up is done at the next advertised speed below 1000 Mbit/s.

The GPY115 also executes an ADS procedure when the signal quality is not suited to a 1000BASE-T link up due to increased alien noise or over long cables.

When the GPY115 is configured to advertise no speed capability below 1000 Mbit/s, the ADS feature is disabled automatically.

3.3.5 Polarity Reversal Correction

For each of the 4 pairs, the GPY115 automatically detects and corrects any inversion of the signal polarity on the P and N signals. The detection is done during the auto-negotiation phase. The detected polarity is frozen once the link has been established, and remains unchanged until the link is dropped.

The polarity corrections applied are indicated in the following register: PMA_MGBT_POLARITY (register 1.130) and are valid when auto-negotiation is complete.

3.3.6 Auto-Crossover Correction

To maximize interoperability, even in inadequate wiring environments, the GPY115 automatically performs cable crossover (MDI-X). The supported pair-mappings detectable and correctable by the device are listed in [Table 12](#).

The purpose is to compensate for any non-standard (ANSI TIA/EIA-568-A:1995) cabling, as well as both straight-through and crossover cable connections: the GPY115 automatically detects and corrects any crossed cable configuration (transmit-receive pairing between partners does not match). The auto-crossover function is fully compliant with IEEE 802.3, Clause 40.4.4 [2], in 1000BASE-T mode.

The corrections applied are indicated in the following register: PMA_MGBT_POLARITY (register 1.130) and are valid when auto-negotiation is complete.

Table 12 Supported Twisted Pair Mappings on a CAT5 or Better Cable

Crossover Modes on RJ45¹⁾		RJ45 Pinning							
Mode	Description	1	2	3	4	5	6	7	8
11	Straight cable, standard compliant	TPIAP (A+)	TPIAN (A-)	TPIBP (B+)	TPICP (C+)	TPICN (C-)	TPIBN (B-)	TPIDP (D+)	TPIDN (D-)
00	Full Gigabit Ethernet MDI-X This is the standard compliant MDI-X with pair A-B swapped and pair C-D swapped	TPIBP (B+)	TPIBN (B-)	TPIAP (A+)	TPIDP (D+)	TPIDN (D-)	TPIAN (A-)	TPICP (C+)	TPICN (C-)

1) Pin assignment according to TIA/EIA-568-A/B

3.3.7 RJ45 Tap Up or Tap Down Configuration

The RJ45 plug on the system PCB can be soldered with the tap up or down as illustrated in [Figure 7](#).

The difference between tap up and tap down is a swap in position between A and D. The pin strap PS_RJ45_TAP allows the system designer to perform this configuration. As a result, a PCB layout does not need to be modified when a RJ45 tap up or down socket needs to be mounted.

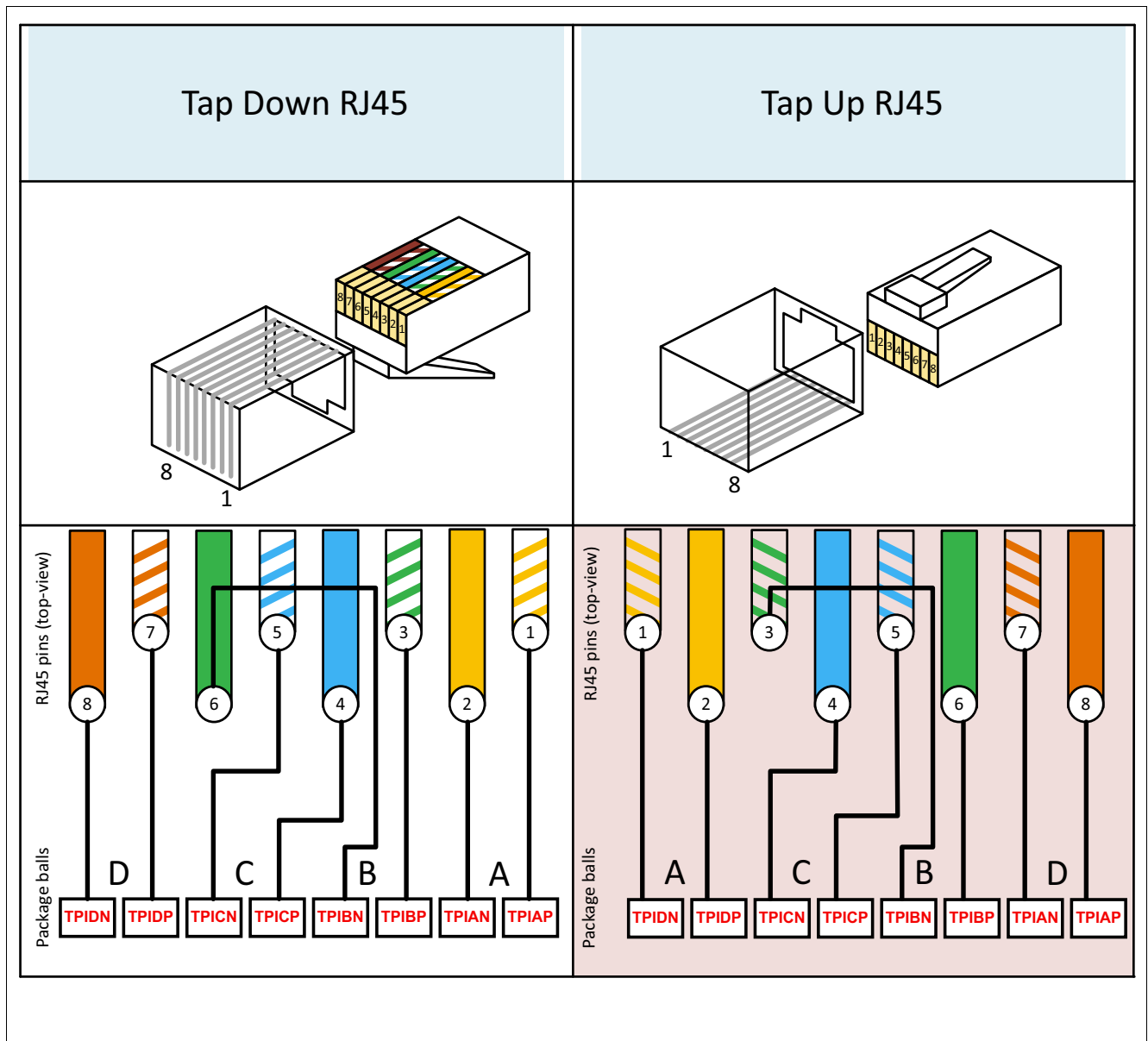

Figure 7 RJ45 Tap Up or Tap Down Configuration

3.3.8 Wake-on-LAN (WoL)

The GPY115 supports Wake-on-LAN. It generates an interrupt to an external controller when it detects special WoL Ethernet packets. This allows the controller to enter sleep mode if there is no Ethernet traffic to process, and be woken up when traffic starts. WoL packets are detected for all link speeds. This scenario is shown in [Figure 8](#).

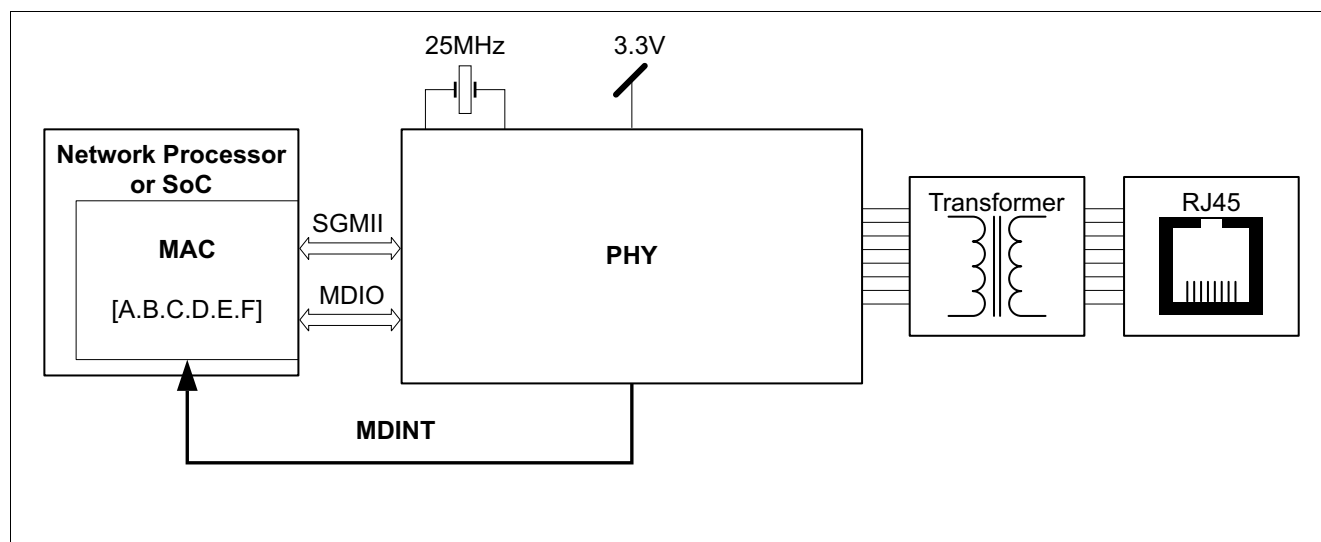

Figure 8 Block Diagram of WoL Application

The most commonly used WoL packet is called a magic packet. A magic packet contains the MAC address of the device to be woken up as well as, optionally, a password called SecureON. The MAC address and the optional SecureON password relevant for the WoL logic inside the GPY115 can be configured in the WOL MDIO registers in “Vendor Specific 2” VSPEC2 MMD device described in [Chapter 4](#). When such a configured magic packet is received by the GPY115, an MDINT interrupt is issued.

An example programming sequence for these configuration registers is given in [Table 13](#).

Table 13 Programming Sequence for the Wake-on-LAN Functionality

Step	Register Access	Remark
1	MDIO.MMD.WOLAD01 = EEFF _H	Program the fifth and sixth MAC address bytes
2	MDIO.MMD.WOLAD23 = CCDD _H	Program the third and fourth MAC address bytes
3	MDIO.MMD.WOLAD45 = AAB _H	Program the first and second MAC address bytes
4	MDIO.MMD.WOLPW01 = 4455 _H	Program the fifth and sixth SecureON password bytes
5	MDIO.MMD.WOLPW23 = 2233 _H	Program the third and fourth SecureON password bytes
6	MDIO.MMD.WOLPW45 = 0011 _H	Program the first and second SecureON password bytes
7	MDIO.PHY.IMASK.WOL = 1 _B	Enable the Wake-on-LAN interrupt mask
8	MDIO.MMD.WOLCTRL.WOL.EN = 1 _B	Enable Wake-on-LAN functionality

3.4 SGMII Interface

The GPY115 implements a serial data interface, called SGMII or SerDes, to connect to another chip implementing the MAC layer (MAC SoC). The data rates supported by the SGMII interface are the same as for the TPI (10 Mbit/s, 100 Mbit/s, 1 Gbit/s). These rates correspond to baud rates of 1.25 Gbaud (for 10/100/1000 Mbit/s using data repetition).

3.4.1 SGMII Control and Status Registers

The GPY115 API [7] describing the driver software executed on the MAC SoC must be followed to configure the SGMII interface.

The MAC SoC can use MDIO registers to retrieve the GPY115 TPI and SGMII status.

The API controls the SGMII interface using 2 MDIO registers described , as shown in **Figure 9**:

- VSPEC1_SGMII_CTRL is used to enable and configure the SGMI auto-negotiation or force a link configuration. Programming this register is optional as the SGMII interface comes up in a default configuration after reset that does not need any additional control from the STA. The STA can also control the SGMII reset, SGMII powerdown or SGMII loop back using this register. Until SGMII is in powerdown (VSPEC1_SGMII_CTRL.PD = 1) state, programming to other bits on VSPEC1_SGMII_CTRL register is ignored.
- VSPEC1_SGMII_STAT is a read-only register that can be used by the STA to retrieve the SGMII link status, data rate and auto-negotiation completion status.

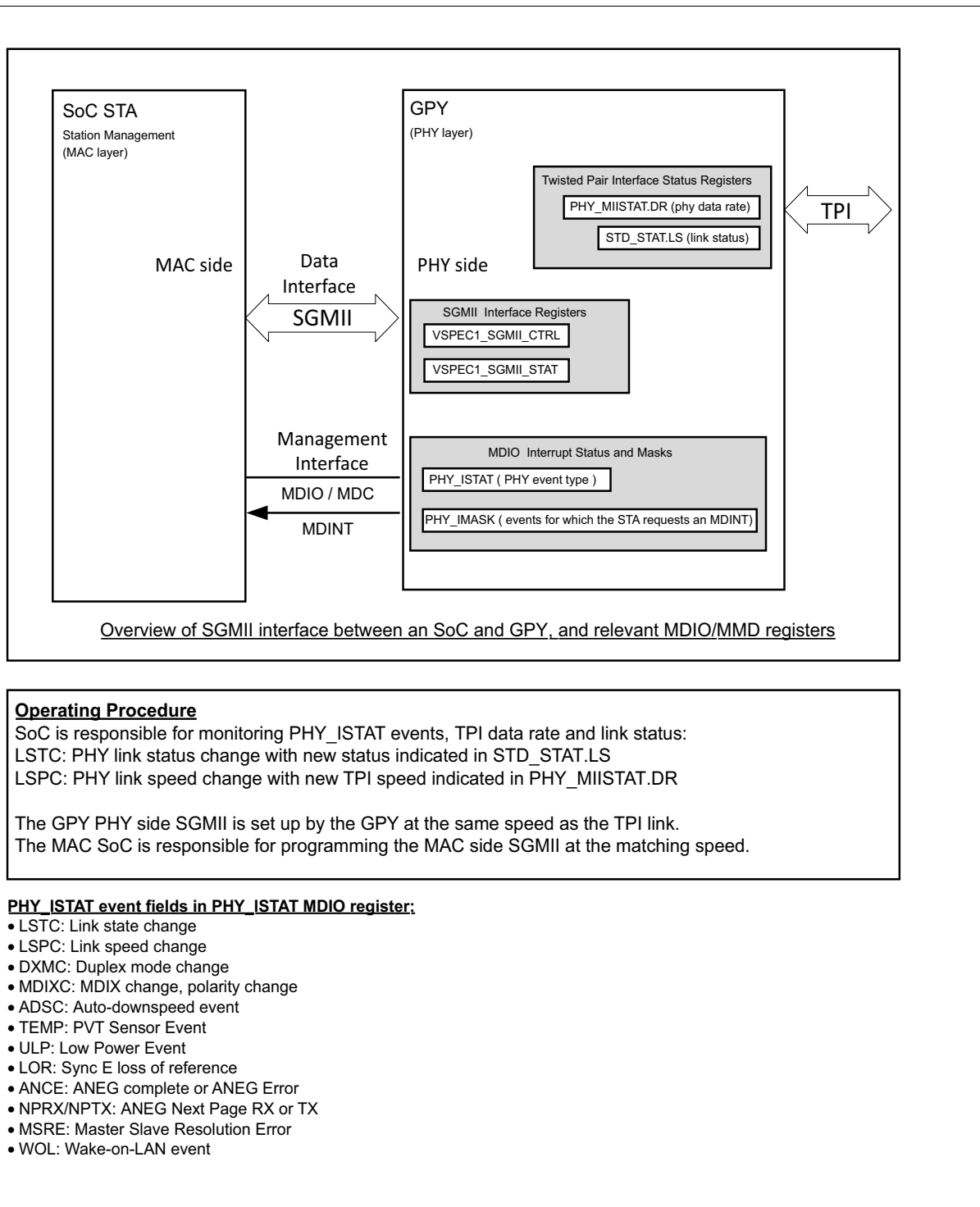

Figure 9 GPY115 SGMII Configuration and Status Registers

3.4.2 SGMII Configuration at Power Up

The GPY115 SGMII interface is configured to operate automatically after reset. The STA does not have to change the register VSPEC1_SGMII_CTRL to operate in this default mode:

- SGMII auto-negotiation is enabled
- The TPI configuration after link up defines the SGMII PHY side configuration. The MAC side SoC must configure its SGMII MAC side interface to match the GPY115 PHY side configuration, as explained in [Chapter 3.4.3](#), [Chapter 0.0.2](#), and [Chapter 3.4.4](#)

3.4.3 SGMII PHY Side Setup According to TPI Setup

The GPY115 PHY side SGMII is set up by the GPY115 at the same speed as the twisted pair interface (TPI) link. To operate the GPY115 in this mode VSPEC1_SGMII_CTRL.FIXED2G5 must be programmed to 0 (default value is 0). This is the default mode.

When a link status changes on the TPI (up/down and speed change), the GPY115 reconfigures its SGMII automatically.

3.4.4 SGMII MAC Side Setup by MAC SoC

The MAC SoC (STA) is responsible for monitoring the PHY_STAT events, which indicate TPI data rate and link status. The MAC SoC can monitor link status or link speed changes using the following three possible methods:

- Using the MDIO interface MDINT interrupt and reading the associated event
- Using the MDIO interface polling (reading) of the link status register STD_STAT.LS
- Using the restart of the SGMII ANEG which conveys the new link parameters. In this case, the SGMII Cisco* ANEG must be enabled after power up.

In all three cases:

- The GPY115 reconfigures the PHY side SGMII to match the TPI setup
- The MAC SoC must set up the MAC side SGMII to match the PHY side SGMII

3.4.5 SGMII Link Monitoring by MAC SoC

The GPY115 indicates its interface status using the following registers, as indicated in [Figure 9](#):

- MDIO register PHY_MIISTAT to indicate the TPI status
- MDIO register SGMII_STAT to indicate the SGMII status

A change of status on the TPI can be indicated by the MDIO interrupt MDINT. MDINT is generated if the STA has programmed the event mask in the PHY_IMASK register corresponding to any of the following events occurring on the TPI:

- LSTC: Link state change
- LSPC: Link speed change
- DXMC: Duplex mode change
- MDIXC: MDIX change, polarity
- ADSC: Auto-downspeed event
- TEMP: PVT Sensor Event
- ULP: Low Power Event
- LOR: Sync E loss of reference
- ANCE: ANEG complete or ANEG error
- NPRX/NPTX: ANEG next page RX or TX
- MSRE: Master Slave Resolution Error
- WOL: Wake-on-LAN

The MDINT signal is deasserted by the GPY115 when the MAC SoC STA performs a READ access to the MDIO register PHY_ISTAT.

The events relevant to the TPI status that are useful for monitoring SGMII are LSTC and LSPC.

3.4.5.1 Actions on TPI Link Down / Link Up Status Change

The GPY115 does not systematically bring the SGMII link down when the TPI link is down.

The STA can read the status on each side (SGMII and TPI) and make the appropriate decision about the SGMII link down.

For example, if the TPI status is in link down for too long, the STA can take the decision to also power down the SGMII.

3.4.5.2 New TPI Link Up at Same Speed

The following scenario describes a transition on TPI that does not require any restart or change of mode on SGMII:

- SGMII is set to a specific speed and SGMII link is up
- TPI goes to link down – and link up
- When TPI is down, the SGMII side is transmitting Idle packets
- TPI links up at the same speed as before

In these cases, the GPY115 does not reprogram the PHY side SGMII.

3.4.6 Auto-negotiation Modes Supported by SGMII

Two modes are supported for the SGMII auto-negotiation protocol:

- Cisco* Serial-GMII Specification 1.8 [3]
- 1000BX IEEE 802.3 following IEEE Clause 37 [2]

The information exchange mechanism of ANEG is the same in both modes, but the parameters communicated are slightly different. The 1000BX scheme allows for some parameters to be aligned with the highest common capability between the two sides of the SerDes. The Cisco* SGMII scheme uses the protocol to communicate the configuration requested by the PHY side SGMII to the MAC side SGMII (e.g. speed request); it is a one-way request.

The parameters communicated by the Cisco* ANEG protocol [3] from SGMII-PHY to SGMII-MAC are:

- Link Up or Link Down indication (reflects the TPI status)
- Half Duplex or Full Duplex mode
- Data rate (standard only supports 10 Mbit/s to 1000 Mbit/s)
- EEE capability support
- EEE Clock Stop capability support

The parameters exchanged by the 1000BX ANEG protocol [2] are:

- Remote fault
- Pause support and mode (symmetrical or asymmetrical)
- Half Duplex or Full Duplex

The Cisco* ANEG protocol is recommended for a standard application.

3.4.6.1 Enabling SGMII Auto-negotiation Mode

SGMII auto-negotiation is ON at power up. ANEG can be enabled/disabled by setting register field VSPEC1_SGMII_CTRL.ANEN. In the default case:

- GPY115 PHY side SGMII is configured by GPY115 to match the TPI link configuration.
- GPY115 uses ANEG to convey the new link parameters to the MAC SoC.
- MAC SoC MAC side SGMII must be configured by the MAC SoC to match the GPY115 PHY side SGMII configuration.

3.5 LED Interface

3.5.1 LED

The GPY115 allows 4 LEDs to be used for visual status indication. Each pin can drive a single color LED or dual color LED.

3.5.2 LED Configuration

The GPY115 API [7] describing the driver software executed on the MAC SoC must be followed to configure this interface.

In single color mode, the external LED can be connected to either the ground or to power as shown in Figure 10. The “power” mode is only supported for single color LEDs.

The connection of single and dual color LEDs, when the pin is also used for pin strapping, is illustrated in Figure 11 and Figure 12.

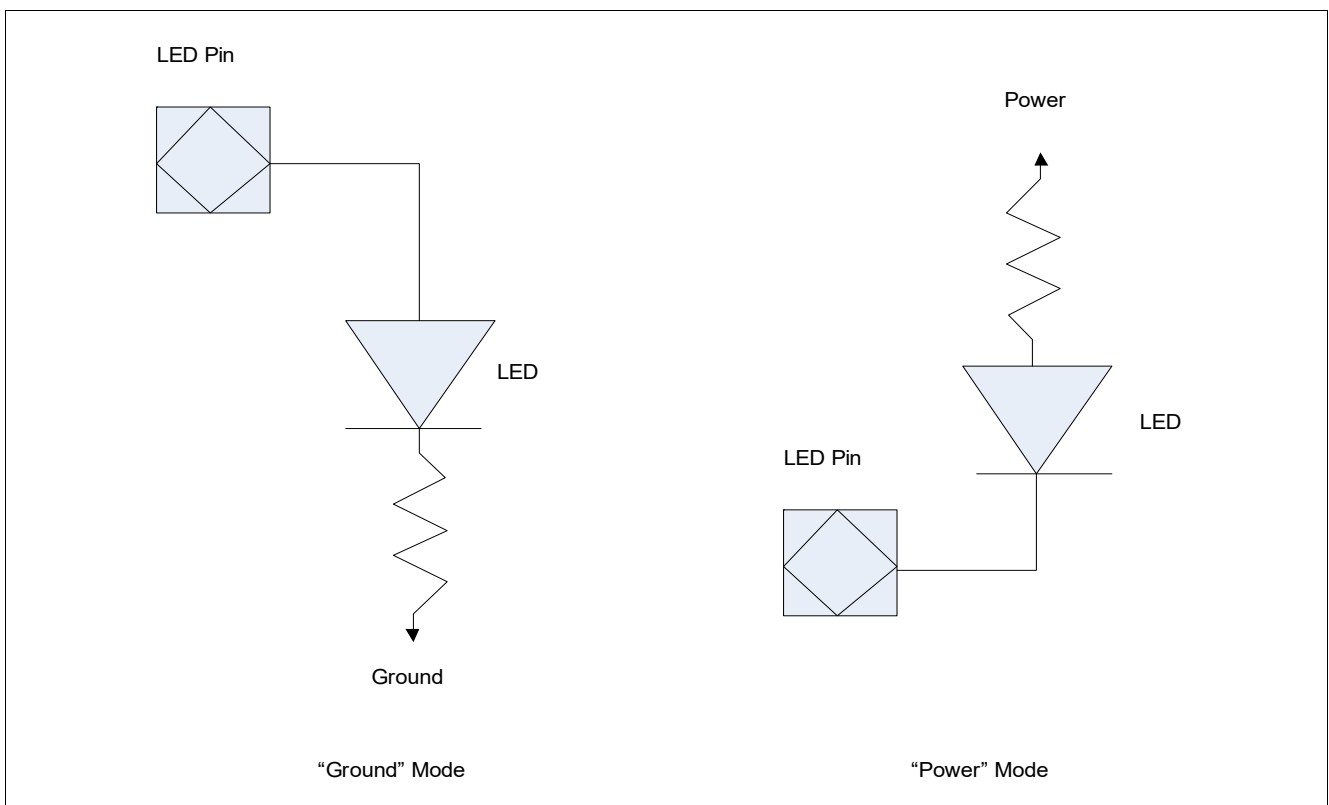

Figure 10 LED Connection Options to Ground or Power Supply

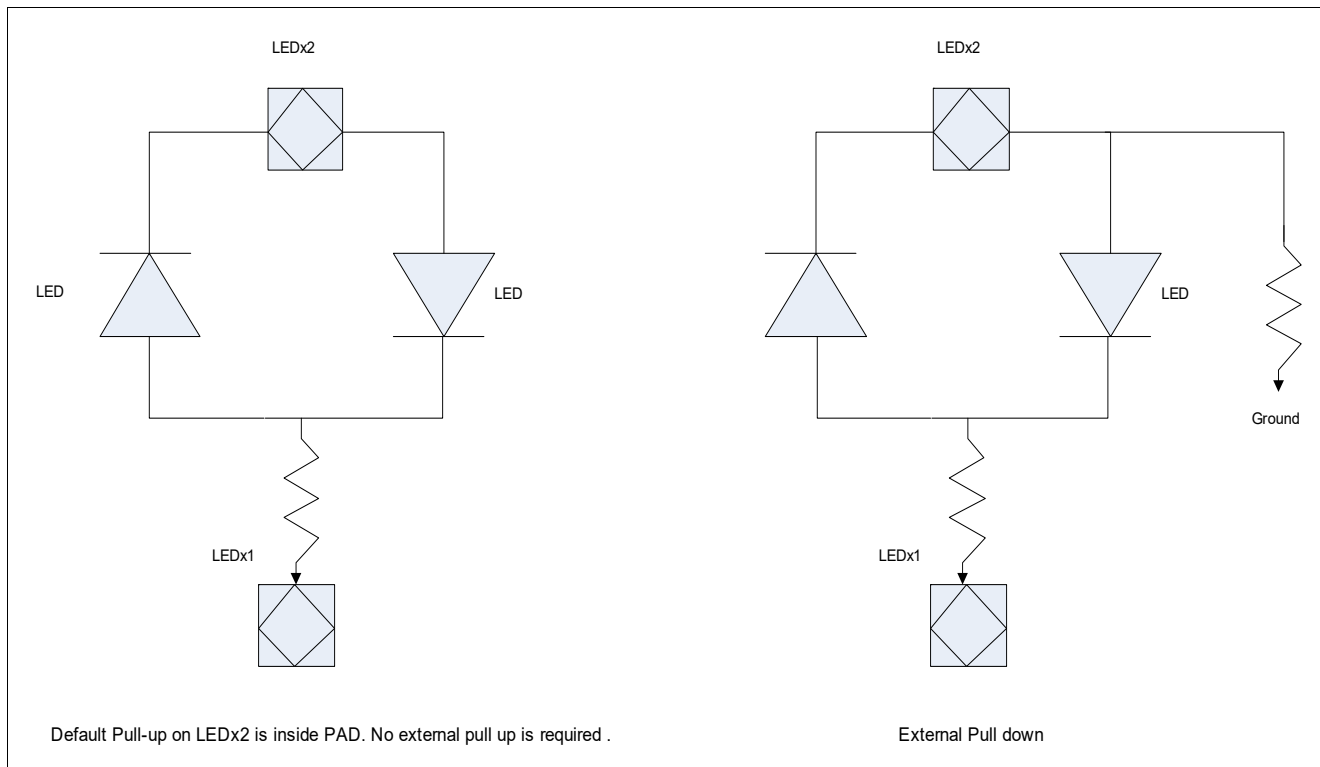

Figure 11 Connection of a Dual Color LED and Configuring Pin Strap Value

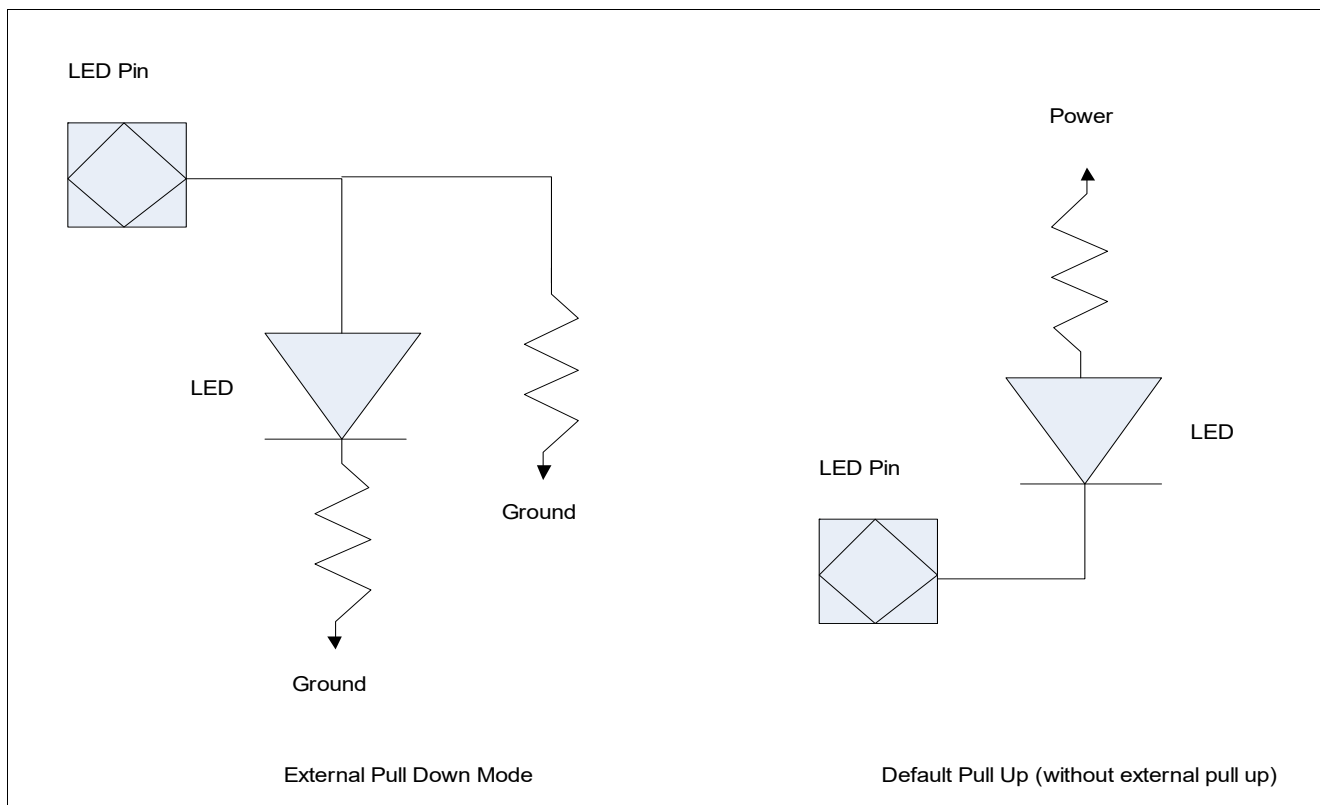

Figure 12 Connection of a Single Color LED and Configuring Pin Strap Value

3.5.3 LED Brightness Control

There are two LED brightness modes configurable by the GPY API, based on the system requirement.

- LED Brightness Level Max Mode
 Fixed level signal (no pulses) for maximum brightness which can also be used as control signal for other purposes.
- LED Brightness Level Control Mode (Constant Mode)
 Allows the configuration of 16 levels of LED brightness as described in [Brightness Control](#).

Brightness Control

This block controls the brightness of the LED by way of controlling the time duration the LED is ON/OFF, and due to persistence of the eye, LED brightness will be perceived. When LED is off, the output is disabled. When LED is on, the output is enabled. Brightness control controls the LED output enable directly.

As show in [Figure 13](#), brightness control frequency is 100Hz. Each period is divided into 64 slots.

When LED brightness control is disabled, LED is enabled in all 64 slots.

When LED brightness control is enabled, LED is enabled for consecutive n slots. n is determined by brightness level configured. LED output is disabled in the 64th slot.



Figure 13 LED Brightness Control By Controlling LED Output Enable/Disable

3.6 Precision Time Protocol (PTP) Feature

3.6.1 PTP Feature Purpose

The GPY115 provides support for Precision Time Protocol (according to PTP Protocol IEEE 1588 Version 2, IEEE 802.1as, and IEEE P802.3bf), which is used to precisely synchronize clocks at the system level. The station manager (STA) can select the GPC1 or GPC2 alternate functions to input a time stamp synchronization request signal (TsSync). For each edge transition on TsSync signal, the GPY115 captures a time stamp. Alternatively, for more precision, the GPY115 supports hardware assisted physical layer time stamping. In this case the TsSync is triggered by the physical layer.

The time stamp is inserted in a PTP event message. The PTP protocol is executed by the STA at the OSI layer above UDP/ IP or MAC layer. The PTP protocol can choose 1-step or 2-step time stamping, and both are supported by the GPY115:

- 2-step time stamping: This scheme uses a Follow_Up message to carry the time stamp of the corresponding sync message. The time stamp is not inserted in the sync message on the fly when the packet is being transmitted, but later in the next PTP message. This scheme allows the GPY115 to perform the hardware assisted precise time stamping capture, using the PHY layer to precisely indicate when the packet Start-of-Frame Delimiter (SFD) symbol is sent out or received on the physical layer. The time stamp, together with the corresponding packet CRC is stored in a memory area on the GPY115. The STA reads this time stamp using the MDIO interface.
- 1-step time stamping: This scheme is used to reduce the number of PTP messages. In this scheme, the GPY115 MAC inserts the time stamp in the sync message on the fly when it passes through the GPY MAC layer. The GPY115 inserts the time stamp in the PTP sync message on the fly.

Special care must be taken at the system level configuration to ensure that the MACsec feature is configured to disable the encryption of PTP time stamp packets, when both PTP and MACsec are enabled concurrently.

3.6.2 PTP Feature Configuration

The GPY115 API [7] describing the driver software executed on the MAC SoC must be followed to configure this feature.

The following steps are used by the API to configure and enable the 1588 feature:

- [Optionally] STA selects GPC1 or GPC2 to be used to input the TsSync, using the GPIO configuration API. This is not required if 2-step PTP mode is chosen, because in that case the TsSync is generated internally by the GPY115 physical layer.
- STA selects 1-step or 2-step PTP mode .
- STA enables 1588 feature: this triggers the GPY115 firmware to configure the internal GMAC and Packet Manager to capture the time stamps of the PTP packets.

3.7 Pulse Per Second (PPS) Feature

3.7.1 PPS Feature Purpose

The GPY115 provides support for PPS signal generation. This can be used at the system level to synchronize various chips. The general purpose clock pins GPC1 and GPC2 can be configured for this purpose.

3.7.2 PPS Feature Configuration

The GPY115 API [7] describing the driver software executed on the MAC SoC must be followed to configure this feature.

The following steps are used by the API to configure and enable the PPS feature:

- Optionally, STA uses the configuration API to configure the desired PPS frequency. By default, it is 1 second.
- STA enables the PPS feature . This triggers the GPY115 firmware to configure the GPY115 to output a PPS signal on the selected GPC1 or GPC2.

3.8 Synchronous Ethernet (Sync-E) Feature

3.8.1 Sync-E Feature Purpose

The GPY115 allows a Synchronous Ethernet (Sync-E) interface to support transportation of a source-referable clock from a clock master to clock clients. If the TPI is a clock slave, the GPY115 receives the synchronization clock from the Ethernet cable, and provides it to the system on pin GPC1 or GPC2. If the TPI is a clock master, the GPY115 receives the clock from the system on pin GPC1 or GPC2 and sends it over the Ethernet cable as a clock master.

3.8.2 Sync-E Feature Configuration

The Sync-E feature is not supported when Internal DC-DC is used.

The GPY115 API [7] describing the driver software executed on the MAC SoC must be followed to configure this feature. The Sync-E feature is enabled using register VSPEC1_PM_CTRL. This triggers the GPY115 to configure the GPC1 or GPC2 pin as a clock master or slave and as Sync-E clock input or output, respectively.

The GPY supports the following SyncE input or output reference clock speeds 1.544 MHz, 2.048 MHz as well as 8 kHz:

- EEC-1 class: 2048 kHz
- EEC-2 class: 1544 kHz
- PSTN class: 8 kHz

3.9 Smart-AZ Feature

The Smart-AZ feature is relevant when the GPY115 is connected to a MAC SoC that does not implement the EEE feature in its MAC layer. In this case, the MAC SoC cannot initiate a transition to the low-power idle state.

To alleviate the limitation of such a MAC SoC, the GPY115 detects the conditions that may lead to low-power idle and generates the control messages to enter EEE mode in accordance with the IEEE 802.3az standard.

The Smart-AZ feature is always enabled.

3.10 MACsec Feature

The GPY115 supports the following MACsec features:

- Compliance to IEEE 802.1AE, IEEE 802.1AEbn and IEEE 802.1AEbw standards
- AES-256 and AES-128 encryption and decryption in both RX and TX directions
- 16 MACsec security channels (SCs) and 32 MACsec associations (SAs)
- The following modes per security association:
 - Integrity check mode only
 - Both confidentiality (data payload encryption) and integrity check mode
- RX non-MACsec packet filtering mode:
 - Forward all packets with Ethernet type different to MACsec type.
- RX MACsec association lookup:
 - If MACsec is enabled, lookup is based on SCI+AN for packets with MACsec tag. If SCI+AN is found, then the packet association is found. The packets with unknown association are forwarded.
 - Unknown association packets are marked with "MACsec unknown" status and counted.
 - There is corresponding MACsec configuration (security mode, key etc) for each association.
 - MACsec tag and ICV (Integrity Check Value) fields are stripped.
- TX MACsec association lookup:
 - With special tag mode, the security channel and MACsec enable/bypass are configurable based on bit 5:0 of the byte 5 in special tag and the packet header.
 - Without special tag mode, the security channel and enable/bypass is based on packet header lookup.
 - There is corresponding MACsec configuration (MACsec enable, security mode etc) for each association.
- MACsec counters:
 - Number of Integrity Check Value (ICV) failed packets
 - Number of MACsec unknown association packets (excluding ICV failed packets)
 - Number of MACsec bypass packets
 - Number of total packets

3.10.1 MACsec Purpose

The GPY115 integrates MACsec frame processing engine hardware to execute MACsec frame transformation along with frame classification and statistic counter updates.

The MACsec engine operates in conjunction with a MACsec driver executed on the MAC SoC. The upper layers of the MACsec protocol in charge of key provisioning are under the control of the MAC SoC.

3.10.2 MACsec Feature Usage

The feature is relevant when the GPY115 is connected to a MAC SoC that does not support MACsec in its Layer-2. In this case, the GPY115 performs the MACsec data transformations that are normally performed by the SoC. The MACsec driver is part of the MAC SoC API software documented in the GPY115 API [7]. The MACsec feature is enabled by default in the GPY115 chip variant. It can be disabled by the API.

Attention: However, to use this feature in GPY115, the host SoC must send the key for MACsec (Secure Association Key - SA Key) in plain text to the GPY115. Hence, this SA Key is exposed on MDIO bus between the host SoC and GPY115. In environments where this plain access to the MACsec SA Key is a concern, it is recommended to use the host SoC to perform the complete end-to-end MACsec encryption/ decryption.

3.10.3 MACsec Engine Control API Executed on MAC SoC

The MACsec engine on the GPY115 is controlled by a MACsec driver executed on the MAC SoC. The control interface is the MDIO.

Attention: When using MACsec, the host MAC must be configured to accept under-size packets. This includes, for example, control words like ARP, PING with correct CRC, which are per se shorter than 64B prior to encryption.

3.11 Power Management

This chapter describes the power management functions of the GPY115.

3.11.1 Power States

Figure 14 illustrates the power states and transition of the GPY115. In this state diagram, the (0.11) syntax corresponds to the value of bit 11 from register 0 in device 0. This is the “PD” power down bit in MDIO STD_CTRL described in **Chapter 4**. The station management can use this STD_CTRL.PD field to bring the physical interface to SLEEP state.

The other states are automatically entered by the GPY115 depending on the context, and following the Energy Efficient Ethernet protocol. This is done without need for any intervention from STA.

Acronyms “NLP” and “FLP” respectively mean “Normal Link Pulse” and “Fast Link Pulse”. These pulses are received on the twisted pair interface from a link partner and used to wake up the GPY115 and enter auto-negotiation.

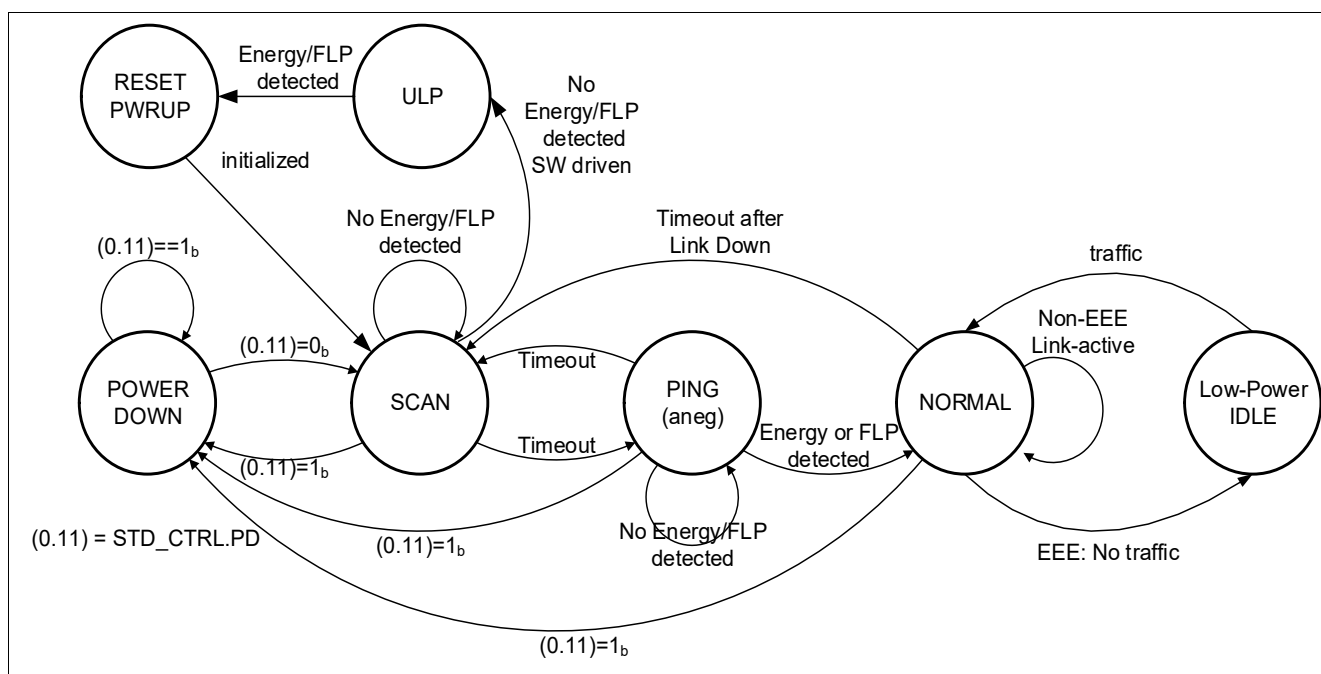

Figure 14 State Diagram for Power Down State Management

3.11.2 RESET Power Up

This is the state in which the GPY115 starts up after either a hardware reset or power up.

Once initialized, the GPY115 will always transition to SCAN state.

3.11.3 SLEEP State

The SLEEP state is entered by setting “power down” bit 11 of the MDIO standard register STD_CTRL (0.11) to logic 1, regardless of the current state of the device. The SLEEP state corresponds to power down as specified in IEEE 802.3, Clause 22.2.4.1.5. Some signal processing blocks are stopped to save energy, but the GPY115 still responds to MDIO messages. The SGMII interface to the MAC SoC is switched off as well.

The SLEEP state exit is triggered by setting the MDIO standard register (0.11), which generates a transition to SCAN state.

3.11.4 SCAN State

The SCAN state differs from the SLEEP state because the receiver periodically scans for signal energy or FLP bursts on the twisted pair interface. There is no transmission in this state. If a FLP burst is received, the GPY115 enters the auto-negotiation protocol to exchange capabilities with the link partner and establish a data link in NORMAL state.

3.11.5 PING State

The PING state is similar to the SCAN state except that the transceiver transmits an FLP burst onto the TPI for a programmable amount of time. This is used to wake potential link partners from the power down state. This state corresponds to the state of “ANEG” described in Clause 28 of the IEEE standard [2].

3.11.6 ULP State

This ultra-low power state is supported in the internal DCDC SVR configuration. This feature is not supported in external supply of the V_{LOW} domain.

Ultra-low power (ULP) state in GPY115 is enabled by configuring MDIO register PHY_CTL2.ULP. The ULP state is entered automatically when there is no Ethernet cable connected to the GPY115. The GPY115 firmware detects this condition when no energy or FLP is present on the twisted pair interface and enters the ULP state. It is intended to set the GPY115 into maximum power saving state. In this state, most digital domains are powered down. Only a minimal amount of circuitry (analog/digital) operates to detect signal energy on the receiver of one twisted pair interface and trigger a wake-up.

When GPY115 is in ULP state, the STA does not have access to the MDIO/MMD registers.

The ULP state is exited upon detection of signal energy on the twisted pair (either NLP or FLP). The GPY115 transitions to the RESET Power Up state automatically. The STA host can also trigger an ULP state exit by applying a reset sequence on the GPY115 using HRSTN pin.

The STA host can be informed of the ULP entry condition and can choose to acknowledge it before granting ULP entry. By setting PHY_IMASK.ULP bit to ACTIVE, the STA requests the MDINT interrupt from GPY115 when the entry conditions are met. If PHY_CTL2.ULP_STA_BLOCK is ON then GPY115 will enter ULP only after STA reads the interrupt status register PHY_ISTAT else the entry to ULP is unconditional. All the ULP related control bits and communication mechanism between STA and GPY is shown in the flowchart in [Figure 15](#).

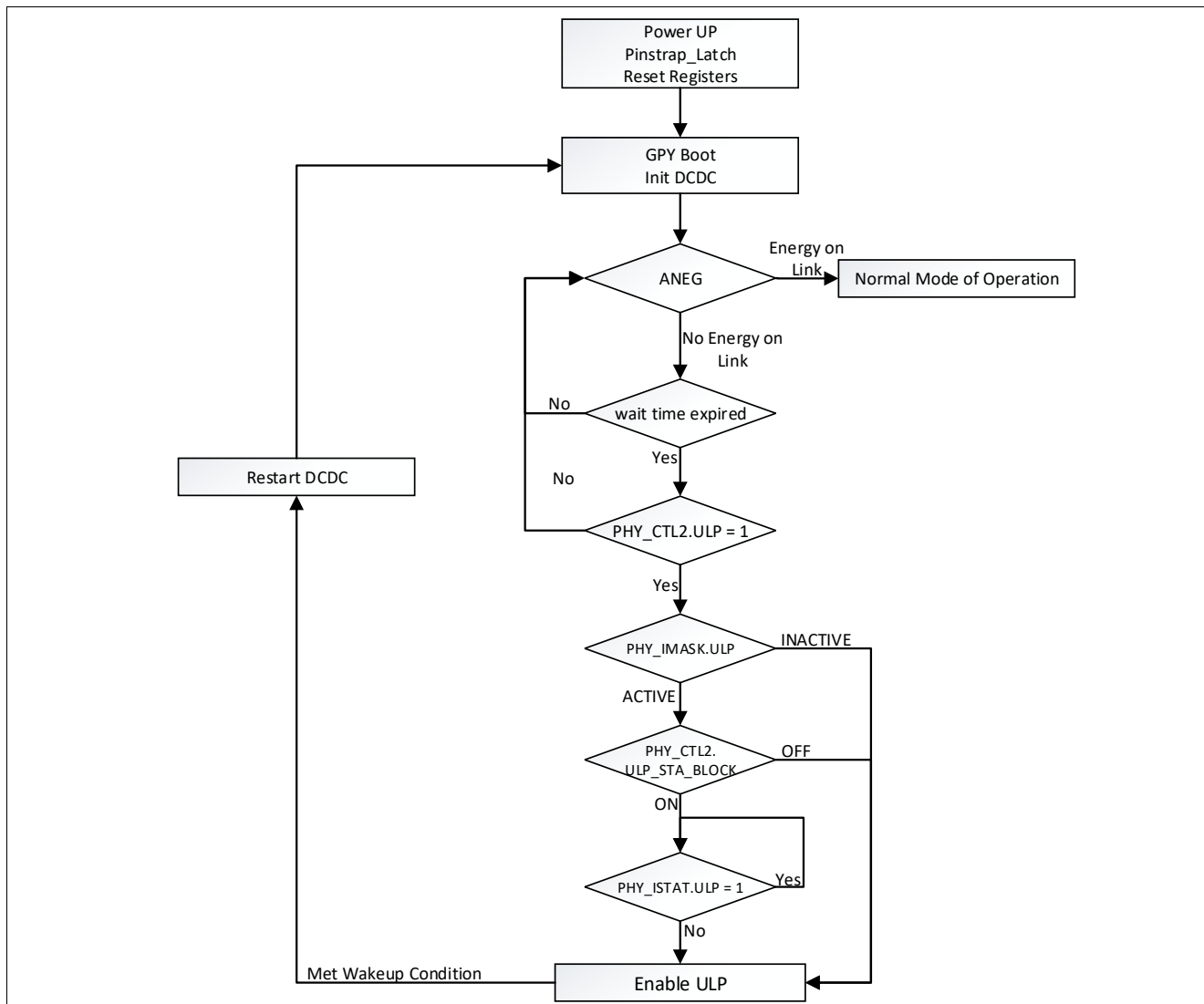

Figure 15 ULP Sequence

Table 14 ULP State Entry and Exit Sequence

Step	State	Remark
1	ACTIVE state, the ULP feature is enabled by programming PHY_CTL2.ULP = 1, if the Internal DCDC is used.	Use MDIO register PHY_CTL2.ULP to enable / disable the ULP feature. With External DCDC, PHY_CTL2.ULP must always be disabled.
2	ANEG, Ability Detect state	The firmware detects that no energy is seen on the cable when no FLP is received for a long period of time. This time can be configured with register: VSPEC1_NBT_DS_C-TRL.NRG_RST_CNT (value to program = time in seconds). Default time is 4 seconds (VSPEC1_NBT_DS_C-TRL.NRG_RST_CNT = 4).
3	ULP Entry	GPY115 saves MDIO ULP persistent registers. GPY115 Internal DCDC SVR ramps down the VDD.

Table 14 ULP State Entry and Exit Sequence (cont'd)

Step	State	Remark
4	ULP State	Power consumption is saved in this state. GPY115 listen to energy pulses from Link Partner ANEG as a condition to trigger ULP exit. Only a minimal amount of circuitry operates to detect signal energy on TPI and trigger a wake-up. GPY115 GPIOs, LEDs and MDIO interface are disabled.
5	ULP Exit, based on Energy detected on cable. (Option 1)	Internal DCDC SVR ramps up the VDD. GPY115 restores the MDIO ULP persistent registers. The STA is responsible to restore any custom MDIO information that were not saved in the group of ULP persistent registers.
6	ULP Exit, based on HRSTN request from STA. (Option 2)	The STA can also request a ULP exit by sending a reset sequence using HRSTN. In this case, the ULP MDIO persistent registers cannot be used, and the GPY115 re-starts from its default MDIO register configuration. The STA must reprogram any MDIO specific configuration.
7	ANEG, LINK-UP and ACTIVE	GPY115 operates in Normal Power Modes.

The list of persistent MDIO register saved and restored during ULP entry-exit is detailed in [Table 15](#) below:

Table 15 ULP Persistent Registers

S.No	Register/Register Field	S.No	Register/Register Field	S.No	Register/Register Field
1	STD_CTRL.SSM	16	PHY_CTL1.POLB	31	VSPEC1_SGMII_CTRL.SSM
2	STD_CTRL.DPLX	17	PHY_CTL1.POLC	32	VSPEC1_SGMII_CTRL.EEE_CAP
3	STD_CTRL.ANEN	18	PHY_CTL1.POLD	33	VSPEC1_SGMII_CTRL.DPLX
4	STD_CTRL.SSL	19	ANEG_CTRL.ANEG_ENAB	34	VSPEC1_SGMII_CTRL.RXIN_V
5	STD_AN_ADV.TAF	20	ANEG_MGBT_AN_CTRL.LDL	35	VSPEC1_SGMII_CTRL.ANEN
6	STD_AN_ADV.XNP	21	ANEG_MGBT_AN_CTRL.FR	36	VSPEC1_SGMII_CTRL.SSL
7	STD_GCTRL.MBTHD	22	ANEG_MGBT_AN_CTRL.FR2G5_BT	37	VSPEC1_NBT_DS_CTRL.NO_NRG_RST
8	STD_GCTRL.MBTFD	23	ANEG_MGBT_AN_CTRL.AB2G5_BT	38	VSPEC1_NBT_DS_CTRL.DO_WNSHIFTEN
9	STD_GCTRL.MS	24	ANEG_MGBT_AN_CTRL.PT	39	VSPEC1_NBT_DS_CTRL.DO_WNSHIFT_THR
10	STD_GCTRL.MSEN	25	ANEG_MGBT_AN_CTRL.MS_MAN_EN	40	VSPEC1_NBT_DS_CTRL.NRG_RST_CNT
11	PHY_IMASK	26	ANEG_MGBT_AN_CTRL.MSCV	41	VSPEC1_PM_CTRL
12	PHY_CTL1.AMDIX	27	ANEG_EEE_AN_ADV1.EEE_100_BT	42	VSPEC1_LED0
13	PHY_CTL1.MDIAB	28	ANEG_EEE_AN_ADV1.EEE_100_OBT	43	VSPEC1_LED1

Table 15 ULP Persistent Registers

S.No	Register/Register Field	S.No	Register/Register Field	S.No	Register/Register Field
14	PHY_CTL1.MDICD	29	ANEG_EEE_AN_ADV2.EEE2G5	44	VSPEC1_LED2
15	PHY_CTL1.POLA	30	VSPEC1_SGMII_CTRL.ANMODE	45	VSPEC1_LED3

3.11.7 NORMAL State

The NORMAL state is used to establish and maintain a link connection. If a connection is dropped, the GPY115 moves back into SCAN state.

3.11.8 Low-Power IDLE State: Energy-Efficient Ethernet

The IEEE 802.3 standard [2] describes the Energy-Efficient Ethernet (EEE) operation that is supported by the GPY115. EEE is supported in the various speeds of 10BASE-T_e, 100BASE-TX, 1000BASE-T. The general idea of EEE is to save power during periods of low link utilization. Instead of sending active idle data, the transmitters are switched off for a short period of time. This is called the quiet period in the standard. The link is kept active by means of a frequent refresh cycle initiated by the PHY itself during low power state. This sequence is repeated until a wake request is generated by one of the link partner MACs. GPY115 follows the IEEE 802.3 standard regarding EEE. The principle is shown in Figure 16. This state is entered automatically when the low-power idle conditions are met.

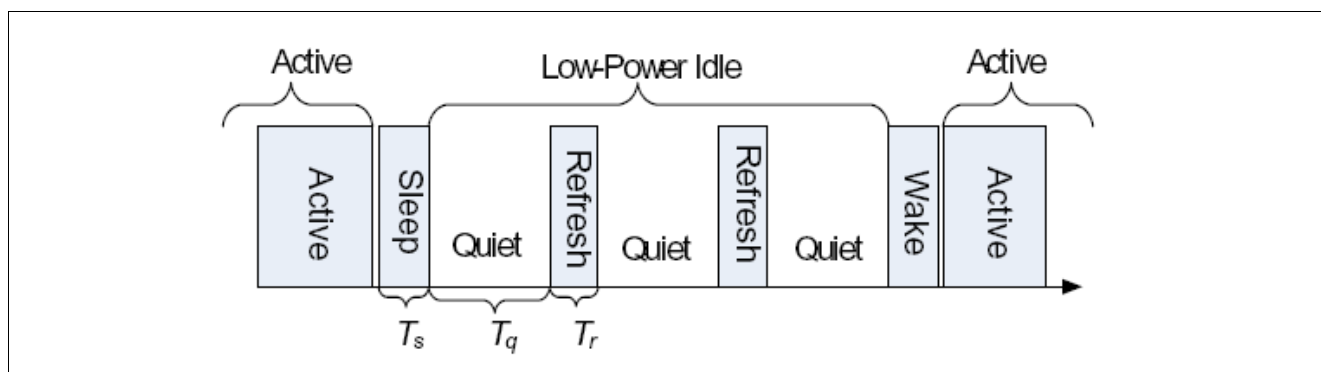

Figure 16 EEE Low-Power Idle Sequence

3.12 Field Firmware Upgrade (FFU)

The GPY115 provides a Firmware Field Upgrade (FFU) feature, that allows feature and functional enhancements of the GPY115 in the field.

Initially, the GPY115 is provided with a permanent on-chip firmware image in a one-time programmable memory (OTP).

With a low-cost serial flash connected to the GPY115's SPI interface, a new firmware image can be downloaded over the GPY115 to the Flash and the GPY115 can fetch the upgraded firmware from this Flash after a reboot.

For security reasons, the GPY115 will only accept firmware images, which are electronically signed by MaxLinear.

In case a Flash image cannot be authenticated by the GPY115 or a Flash image download is aborted or fails, the GPY115 will default to run from the internal firmware image in OTP.

The GPY API [7] describing the driver software executed on the MAC SoC must be followed to execute this feature. It provides information on the update process and which actions are required in the MAC SoC application.

Functional Description

Security features to prevent rollback of image to a previous version (Flash Anti-Rollback) and to prevent flash wear-out due to too frequent update (Flash Anti-wear out) are not supported within the GPY115. If the system (SoC) to which the GPY115 is attached, mandates such features, they can be supported by the system.

- The host software is expected to verify a firmware before downloading it to the flash, and that the version number of the new firmware is higher than the one installed.
- The system is also expected to ensure that a firmware is only installed when there is a new firmware available and not, for instance, after every reboot.
- Flash memory components typically support a minimum of 100,000 erase/program cycles, so flash wear-out is unlikely. However, ensuring a minimum interval between flash updates decreases the likelihood of wear-out. An interval of 1 hour sets the minimal time of wear-out to more than 11 years.

4 MDIO and MMD Register Interface Description

The following sections describe the MDIO and MMD registers, which are standardized by IEEE 802.3 [2], and available to support the GPY115 feature set. These registers can be accessed by an external management entity (also called STA in IEEE) to control, configure or read the status of the GPY115. After power-on, the GPY115 resets the MDIO and MMD registers to default values that are sufficient to operate without specific programming.

All the register definitions, behaviors and fields are strictly compliant with the IEEE 802.3 [2]. Refer to IEEE 802.3 for more detailed explanations of the registers. The only registers that are not referenced in IEEE 802.3 are two register groups that are “vendor specific”: VSPEC1 and VSPEC2. These allow custom functions related to the GPY115. In the register descriptions, the section or table references refer to the IEEE 802.3 [2] documents.

4.1 Definitions

The following acronyms are used in the IEEE 802.3 standard and commonly used in the Ethernet technical domain:

- **STA:** Station Management. A host connected to the MDIO interface. STAs are generally Media Access Controllers (MACs). The STA drives the MDIO bus as a clock master and the GPY115 is MDIO slave.
- **Host:** Used as a synonym of STA in this document.
- **PHY:** Physical Layer. In the GPY115 this encompasses Analog Signal Processing, Digital Signal Processing, PCS. The PHY contains several sub-layers that are individually manageable entities known as MDIO manageable devices (MMDs).
- **MMD:** MDIO Manageable Device. The list of MMDs available in the GPY115 is in [Chapter 4.3](#).
- **Device:** In the context of MDIO/MMD registers, a device is a register bank grouped by logical sub-layers of the PHY layer.
- **Clause:** Refers to a particular section of the IEEE 802.3 standard [2]. In particular Clause 22 describes MDIO device 0, and Clause 45 describes the other MMDs.
- **MII:** Media Independent Interface. This encompasses the MDIO as well as the (G)MII as described in Clause 22. STD registers in device 0 are also called MII registers.

4.2 Register Naming and Numbering

The register numbering convention in this document is similar to that of IEEE 802.3:

The numbering syntax uses 3 numbers “a.b.c” as specified in IEEE 802.3 paragraph 45.1, and the notation is generalized to Clause 22 registers in device 0 “STD”. The alphanumeric syntax also uses the same structure and uses the names of the MMD devices, registers and register fields separated by underscore and dot as described below.

4.2.1 Register Numbering

The syntax is as follows, with a, b, c written as decimal numbers:

a.b.c = <DEVICE_NUMBER>.<REGISTER_NUMBER>.<FIELD_NUMBER>

When the last indicator (c) is omitted, the register numbering refers to the full register.

When a field is more than a single bit, the bit range is indicated using a semicolon (e.g. 1:3 is the field of bits 1 to 3). In an MDIO register, the least significant bit is bit 0 and most significant bit is bit 15. All MDIO registers are 16 bit wide.

4.2.2 Register Naming

The syntax is as follows, with AA, BB, CC written as alphanumeric strings:

AA.BB.CC = <DEVICE_NAME>_<REGISTER_NAME>.<FIELD_NAME>

When the last indicator (CC) is omitted, the register naming refers to the full register.

The fields named Res, RES1, RES2 refer to reserved fields as per IEEE 802.3 documents.

4.2.3 Examples

STD_STAT.ANOK is the name of the field 0.1.5, which indicates auto-negotiation complete.

ANEG_CTRL.ANEG_RESTART is the name of the field 7.0.9, which allows the STA to restart the Ethernet ANEG procedure.

ANEG_PHYID1 is the complete 16-bit register number 7.2, for the PHY identifier 1 number.

VSPEC1_LED1.BLINKS is the 4-bit wide field number 30.2.15:12, which contains LED1 slow blinking configuration.

4.3 MMD Devices Present in GPY115

The MMD devices implement groups of standardized registers under the management of the STA. They are defined in IEEE 802.3.

Table 16 MDIO / MMD Devices Present in GPY115

MDIO / MMD Name	Device Number (decimal)	Description
STD	0	MDIO Standard Device as described in Clause 22. This also contains a number of PHY registers that are GPY115 specific.
PMAPMD	1	Control and status registers related to PMA/PMD signal processing modules.
PCS	3	Control and status registers related to PCS encoding/decoding device.
ANEG	7	Control and status registers related to auto-negotiation device.
VSPEC1	30	GPY115-specific LED control and GPY115 SGMII control.
VSPEC2	31	GPY115-specific Wake-on-LAN control.

4.4 Responsibilities of the STA

The GPY115 responds to all published register addresses for the device and returns a value of zero for undefined and unsupported registers.

As per IEEE 802.3 guidelines, it is the responsibility of the STA entity to ensure that mutually acceptable speeds are applied consistently across all the MMDs of the GPY115.

The GPY115 ignores writes to the PMA/PMD speed selection bits that select speeds which are not advertised in the PMA/PMD speed ability register. The PMA/PMD speed selection defaults to a supported ability.

4.5 MDIO Access Protocols to Read / Write Registers

All the MDIO/MMD registers can be accessed from an external chip connected to the MDIO bus on the MDIO and MDC pins. The GPY115 supports several MDIO frame protocols:

- Clause 22: To access Device 0
- Clause 22 Extended: To access other devices (Dev 1: PMAPMD, Dev 3: PCS, Dev7: ANEG, Dev 30: VSPEC1, DEV 31: VSPEC2) using the indirection scheme specified by IEEE 802.3.
- Clause 45: to access all devices

Both Clause 22 Extended and Clause 45 can be used to access MMD devices. However, the mechanism implemented in the GPY115 provides faster speeds using Clause 45, so there are some differences in latencies in the MDIO reply:

- Protocol "Clause 22 Extended" involves the GPY115 an indirection mechanism.
- Protocol "Clause 45" provides faster replies.

The Clause 22 registers can be accessed using the Clause 45 electrical interface and the Clause 22 management frame structure [IEEE 802.3 section 45.2].

5 MDIO Registers Detailed Description

Table 17 Register Access Type

Mode	Symbol
Status Register, (Status, or Ability Register)	RO
Read-Write Register, (e.g. MDIO Register)	RW
Read-Write, Self-Clearing Register (bit is cleared after read from MDIO)	RWSC

Attention: As GPY115 is a 1G speed product, the maximum speed capability available in the registers is 1G. Any speed request higher than 1G (2.5G, 5G, 10G) defaults to 1G.

5.1 Standard Management Registers

This section describes the IEEE 802.3 standard management registers corresponding to Clause 22.

Table 18 Registers Overview

Register Short Name	Register Long Name	Reset Value
STD_CTRL	STD Control (Register 0.0)	3040 _H
STD_STAT	Status Register (Register 0.1)	7949 _H
STD_PHYID1	PHY Identifier 1 (Register 0.2)	67C9 _H
STD_PHYID2	PHY Identifier 2 (Register 0.3)	DC00 _H ¹⁾
STD_AN_ADV	Auto-Negotiation Advertisement (Register 0.4)	0DE1 _H
STD_AN_LPA	Auto-Negotiation Link Partner Ability (Register 0.5)	11E0 _H
STD_AN_EXP	Auto-Negotiation Expansion (Register 0.6)	0064 _H
STD_AN_NPTX	Auto-Negotiation Next Page Transmit Register (Register 0.7)	2001 _H
STD_AN_NPRX	Auto-Negotiation Link Partner Received Next Page Register (Register 0.8)	0000 _H
STD_GCTRL	Gigabit Control Register (Register 0.9)	0200 _H
STD_GSTAT	Gigabit Status Register (Register 0.10)	0000 _H
STD_MMDCTRL	MMD Access Control Register (Register 0.13)	0000 _H
STD_MMDDATA	MMD Access Data Register (Register 0.14)	0000 _H
STD_XSTAT	Extended Status Register (Register 0.15)	2000 _H

1) For the device specific reset value, refer to the Product Naming table in the [Package Outline](#) chapter.

5.1.1 Standard Management Registers

This chapter describes all registers of STD in detail.

STD Control (Register 0.0)

This register controls the main functions of the PHY.

IEEE Standard Register=0.0

STD_CTRL										Reset Value	
STD Control (Register 0.0)										3040 _H	
15	14	13	12	11	10	9	8	7	6	5	0
RST	LB	SSL	ANEN	PD	ISOL	ANRS	DPLX	COL	SSM		RES
rwsc	rw	rw	rw	rw	rw	rwsc	rw	rw	rw		ro

Field	Bits	Type	Description
RST	15	RWSC	<p>Reset Resets the PHY to its default state. Active links are terminated. Note that this is a self-clearing bit which is set to zero by the hardware after reset has been done. See also IEEE 802.3-2008 22.2.4.1.1.</p> <p>0_B NORMAL Normal operational mode 1_B RESET Resets the device</p>
LB	14	RW	<p>Loop-Back on GMII This mode enables looping back of MII data (SGMII) from the transmit to the receive direction. No data is transmitted to the Ethernet PHY. The device operates at the selected speed. The collision signal remains de-asserted unless otherwise forced by the collision test.</p> <p>0_B NORMAL Normal operational mode 1_B ENABLE Closes the loop-back from TX to RX at xMII</p>
SSL	13	RW	<p>Forced Speed Selection LSB This bit only takes effect when the auto-negotiation process is disabled, that is, bit ANEN is set to zero. This is the lower bit (LSB) of the forced speed selection. In conjunction with the higher bit (MSB) , the following encoding is valid: MSB LSB bit values: 0 0 = 10 Mbit/s 0 1 = 100 Mbit/s 1 0 = 1000 Mbit/s 1 1 = Reserved, defaults to 2500 Mb/s if the PMA_CTRL register 1.0.5:2 is equal to [0 1 1 0] The standard procedure to force the 2500 Mb/s (when ANEG is disabled) is to program PMA_CTRL with 1.0.6 = 1.0.13 = 1 and 1.0.5:2 = [0 1 1 0] GPY PHY mirrors 1.0.6, 1.0.13 and 0.0.6 , 0.0.13</p>
ANEN	12	RW	<p>Auto-Negotiation Enable Allows enabling and disabling of the auto-negotiation process capability of the PHY. If enabled, the force bits for duplex mode (CTRL.DPLX) and the speed selection (CTRL.SSM, CTRL.SSL) become inactive. Otherwise, the force bits define the PHY operation. See also IEEE 802.3-2008 22.2.4.1.4.</p> <p>0_B DISABLE Disable the auto-negotiation protocol 1_B ENABLE Enable the auto-negotiation protocol</p>
PD	11	RW	<p>Power Down Forces the device into a power down state (SLEEP) in which power consumption is the bare minimum required to still maintain the MII management interface communication. When activating the power down functionality, the PHY terminates active data links. The MII interface is also stopped in power down mode. See also IEEE 802.3-2008 22.2.4.1.5.</p> <p>0_B NORMAL Normal operational mode 1_B POWERDOWN Forces the device into power down mode</p>

Field	Bits	Type	Description (cont'd)
ISOL	10	RW	<p>Isolate The isolation mode isolates the PHY from the MAC. MAC interface inputs are ignored, whereas MAC interface outputs are set to tristate (high-impedance). See also IEEE 802.3-2008 22.2.4.1.6.</p> <p>0_B NORMAL Normal operational mode 1_B ISOLATE Isolates the PHY from the MAC</p>
ANRS	9	RWSC	<p>Restart Auto-Negotiation Restarts the auto-negotiation process on the MDI. This bit does not take any effect when auto-negotiation is disabled using (CTRL.ANEN). Note that this bit is self-clearing after the auto-negotiation process is initiated. See also IEEE 802.3-2008 22.2.4.1.7.</p> <p>0_B NORMAL Stay in current mode 1_B RESTART Restart auto-negotiation</p>
DPLX	8	RW	<p>Forced Duplex Mode Note that this bit only takes effect when the auto-negotiation process is disabled, that is, bit CTRL.ANEN is set to zero. This bit controls the forced duplex mode. It allows forcing of the PHY into full or half-duplex mode. Note that this bit does not take effect in loop-back mode, that is, when bit CTRL.LB is set to "1". See also IEEE 802.3-2008 22.2.4.1.8.</p> <p>The Duplex mode can only be forced to Half Duplex in 10BT and 100BT speed modes. This field is ignored for higher speeds.</p> <p>0_B HD Half duplex 1_B FD Full duplex</p>
COL	7	RW	<p>Collision Test Allows testing of the COL signal at the xMII interface. When the collision test is enabled, the state of the TX_EN signal is looped back to the COL signal within a minimum latency. See also IEEE 802.3-2008 22.2.4.1.9.</p> <p>0_B DISABLE Normal operational mode 1_B ENABLE Activates the collision test</p>
SSM	6	RW	<p>Forced Speed Selection MSB This bit only takes effect when the auto-negotiation process is disabled, that is, bit ANEN is set to zero.</p> <p>This is the most significant bit (MSB) of the forced speed selection. In conjunction with the lower bit, (LSB), the following encoding is valid: MSB LSB: 0 0 = 10 Mbit/s 0 1 = 100 Mbit/s 1 0 = 1000 Mbit/s 1 1 = Reserved, defaults to 2500 Mb/s if the PMA_CTRL (1.0.5:2 = [0 1 1 0])</p> <p>The preferred way to force the 2500 Mb/s (when ANEG is disabled) is to program PMA_CTRL with 1.0.6 = 1.0.13 = 1 and 1.0.5:2 = [0 1 1 0] GPY mirrors 1.06, 1.0.13 and 0.0.6 , 0.0.13</p>
RES	5:0	RO	<p>Reserved Write as zero, ignore on read.</p>

Status Register (Register 0.1)

This register contains status and capability information about the device. Note that all bits are read-only. A write access by the MAC does not have any effect. See also IEEE 802.3-2008 22.2.4.2.

IEEE Standard Register=0.1

STD_STAT

Reset Value

Status Register (Register 0.1)

7949_H

15	14	13	12	11	10	9	8	7	6	5	4	3	2	1	0	
CBT4	CBTX F	CBTX H	XBTF	XBTH	CBT2F	CBT2 H	EXT	RES	MFPS	ANOK	RF	ANAB	LS	JD	XCAP	
ro	ro	ro	ro	ro	ro	ro	ro	ro	ro	ro	ro	rolh	ro	roll	rolh	ro

Field	Bits	Type	Description
CBT4	15	RO	IEEE 100BASE-T4 Specifies the 100BASE-T4 ability. 0 _B DISABLED PHY does not support this mode 1 _B ENABLED PHY supports this mode
CBTXF	14	RO	IEEE 100BASE-TX Full-Duplex Specifies the 100BASE-TX full-duplex ability. 0 _B DISABLED PHY does not support this mode 1 _B ENABLED PHY supports this mode
CBTXH	13	RO	IEEE 100BASE-TX Half-Duplex Specifies the 100BASE-TX half-duplex ability. 0 _B DISABLED PHY does not support this mode 1 _B ENABLED PHY supports this mode
XBTF	12	RO	IEEE 10BASE-T Full-Duplex Specifies the 10 BASE-T full-duplex ability. 0 _B DISABLED PHY does not support this mode 1 _B ENABLED PHY supports this mode
XBTH	11	RO	IEEE 10BASE-T Half-Duplex Specifies the 10BASE-T half-duplex ability. 0 _B DISABLED PHY does not support this mode 1 _B ENABLED PHY supports this mode
CBT2F	10	RO	IEEE 100BASE-T2 Full-Duplex Specifies the 100BASE-T2 full-duplex ability. 0 _B DISABLED PHY does not support this mode 1 _B ENABLED PHY supports this mode
CBT2H	9	RO	IEEE 100BASE-T2 Half-Duplex Specifies the 100BASE-T2 half-duplex ability. 0 _B DISABLED PHY does not support this mode 1 _B ENABLED PHY supports this mode

Field	Bits	Type	Description (cont'd)
EXT	8	RO	<p>Extended Status The extended status registers are used to specify 1000 Mbit/s speed capabilities in the register XSTAT. See also IEEE 802.3-2008 Clause 22.2.4.2.16.</p> <p>0_B DISABLED No extended status information available in register 15 1_B ENABLED Extended status information available in register 15</p>
RES	7	RO	<p>Reserved Ignore when read.</p>
MFPS	6	RO	<p>Management Preamble Suppression Specifies the MF preamble suppression ability. See also IEEE 802.3-2008 22.2.4.2.9.</p> <p>0_B DISABLED PHY requires management frames with preamble 1_B ENABLED PHY accepts management frames without preamble</p>
ANOK	5	RO	<p>Auto-Negotiation Completed Indicates whether the auto-negotiation process is completed or in progress. See also IEEE 802.3-2008 22.2.4.2.10.</p> <p>0_B RUNNING Auto-negotiation process is in progress 1_B COMPLETED Auto-negotiation process is completed</p>
RF	4	ROLH	<p>Remote Fault Indicates the detection of a remote fault event. See also IEEE 802.3-2008 22.2.4.2.11.</p> <p>0_B INACTIVE No remote fault condition detected 1_B ACTIVE Remote fault condition detected</p>
ANAB	3	RO	<p>Auto-Negotiation Ability Specifies the auto-negotiation ability. See also IEEE 802.3-2008 22.2.4.2.12.</p> <p>0_B DISABLED PHY is not able to perform auto-negotiation 1_B ENABLED PHY is able to perform auto-negotiation</p>
LS	2	ROLL	<p>Link Status Indicates the link status of the PHY to the link partner. See also IEEE 802.3-2008 22.2.4.2.13.</p> <p>0_B INACTIVE The link is down. No communication with link partner possible. 1_B ACTIVE The link is up. Data communication with link partner is possible.</p>
JD	1	ROLH	<p>Jabber Detect Indicates that a jabber event has been detected. See also IEEE 802.3-2008 22.2.4.2.14.</p> <p>0_B NONE No jabber condition detected 1_B DETECTED Jabber condition detected</p>
XCAP	0	RO	<p>Extended Capability Indicates the availability and support of extended capability registers. See also IEEE 802.3-2008 22.2.4.2.15.</p> <p>0_B DISABLED Only base registers are supported 1_B ENABLED Extended capability registers are supported</p>

PHY Identifier 1 (Register 0.2)

This code specifies the Organizationally Unique Identifier (OUI), and the vendor's model and revision number.
IEEE Standard Register=0.2

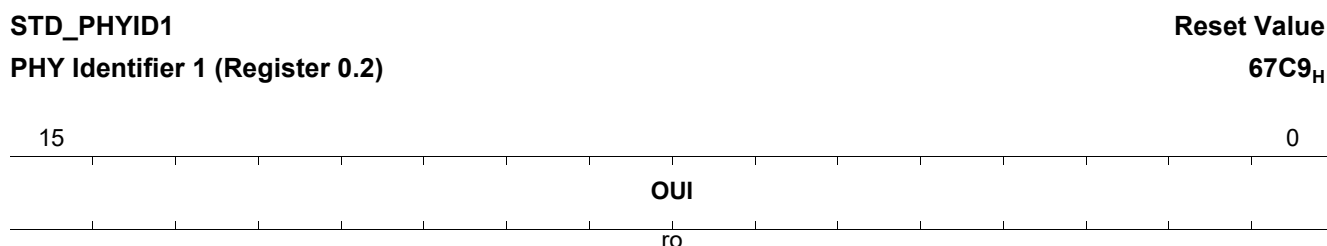

Field	Bits	Type	Description
OUI	15:0	RO	Organizationally Unique Identifier Bits 3:18

PHY Identifier 2 (Register 0.3)

IEEE Standard Register=0.3

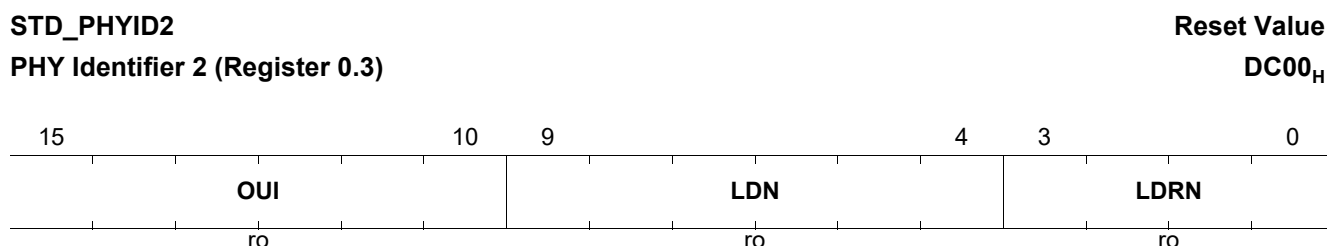

Field	Bits	Type	Description
OUI	15:10	RO	Organizationally Unique Identifier Bits 19:24
LDN	9:4	RO	Device Number Specifies the device number ¹⁾ to distinguish between several products.
LDRN	3:0	RO	Device Number Specifies the device revision number ¹⁾ to distinguish between several versions of this device.

1) For the device specific reset value, refer to Product Naming table in the [Package Outline](#) chapter.

Auto-Negotiation Advertisement (Register 0.4)

This register contains the advertised abilities of the PHY during auto-negotiation.

IEEE Standard Register=0.4

STD_AN_ADV

Reset Value

Auto-Negotiation Advertisement (Register 0.4)

0DE1_H

	15	14	13	12	11					5	4				0
	NP	RES	RF	XNP					TAF					SF	
	rw	ro	rw	rw					rw					rw	

Field	Bits	Type	Description
NP	15	RW	Next Page Next page indication is encoded in bit AN_ADV.NP regardless of the selector field value or link code word encoding. The PHY always advertises NP if a 1000BASE-T mode is advertised during auto-negotiation. See also IEEE 802.3-2008 28.2.1.2.6. 0 _B INACTIVE No next page(s) will follow 1 _B ACTIVE Additional next page(s) will follow
RES	14	RO	Reserved Write as zero, ignore on read.
RF	13	RW	Remote Fault The remote fault bit allows indication of a fault to the link partner. See also IEEE 802.3-2008 28.2.1.2.4. 0 _B NONE No remote fault is indicated 1 _B FAULT A remote fault is indicated
XNP	12	RW	Extended Next Page Indicates that GPY supports transmission of Extended Next Pages (XNP). 0 _B UNABLE GPY is XNP unable 1 _B ABLE GPY is XNP able
TAF	11:5	RW	Technology Ability Field The technology ability field is an 8-bit wide field containing information indicating supported technologies. GPY supports 10BASE-T (Half and Full Duplex), 100BASE-TX (Half and Full Duplex) and both symmetric and asymmetric PAUSE. 40 _H PS_ASYM Advertise asymmetric pause 20 _H PS_SYM Advertise symmetric pause 10 _H DBT4 Advertise 100BASE-T4 08 _H DBT_FDX Advertise 100BASE-TX full duplex 04 _H DBT_HDX Advertise 100BASE-TX half duplex 02 _H XBT_FDX Advertise 10BASE-T full duplex 01 _H XBT_HDX Advertise 10BASE-T half duplex

Field	Bits	Type	Description (cont'd)
SF	4:0	RW	Selector Field The selector field is a 5-bit wide field for encoding 32 possible messages. Selector field encoding definitions are shown in IEEE 802.3-2008 Annex 28A. Combinations not specified are reserved for future use. Reserved combinations of the selector field are not to be transmitted. See also IEEE 802.3-2008 28.2.1.2.1. 00001 _B IEEE802DOT3 Select the IEEE 802.3 technology

Auto-Negotiation Link Partner Ability (Register 0.5)

IEEE Standard Register=0.5

When the auto-negotiation is complete, this register contains the advertised ability of the link partner. The bit definitions are a direct representation of the received link code word .

STD_AN_LPA

Reset Value

Auto-Negotiation Link Partner Ability (Register 0.5)

11E0_H

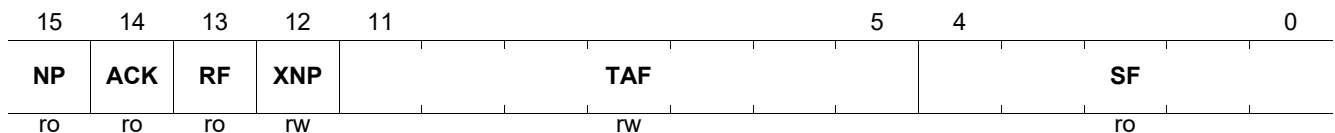

Field	Bits	Type	Description
NP	15	RO	Next Page Next page request indication from the link partner. See also IEEE 802.3-2008 28.2.1.2.6. 0 _B INACTIVE No next page(s) will follow 1 _B ACTIVE Additional next pages will follow
ACK	14	RO	Acknowledge Acknowledgement indication from the link partner's link code word. See also IEEE 802.3-2008 28.2.1.2.5. 0 _B INACTIVE The device did not successfully receive its link partner's link code word 1 _B ACTIVE The device has successfully received its link partner's link code word
RF	13	RO	Remote Fault Remote fault indication from the link partner. See also IEEE 802.3-2008 28.2.1.2.4. 0 _B NONE Remote fault is not indicated by the link partner 1 _B FAULT Remote fault is indicated by the link partner
XNP	12	RW	Extended Next Page Indicates that GPY supports transmission of Extended Next Pages (XNP). 0 _B UNABLE Link partner is XNP unable 1 _B ABLE Link partner is XNP able

Field	Bits	Type	Description (cont'd)
TAF	11:5	RW	Technology Ability Field 40 _H PS_ASYM Advertise asymmetric pause 20 _H PS_SYM Advertise symmetric pause 10 _H DBT4 Advertise 100BASE-T4 08 _H DBT_FDX Advertise 100BASE-TX full duplex 04 _H DBT_HDX Advertise 100BASE-TX half duplex 02 _H XBT_FDX Advertise 10BASE-T full duplex 01 _H XBT_HDX Advertise 10BASE-T half duplex
SF	4:0	RO	Selector Field 00001 _B IEEE802DOT3 Select the IEEE 802.3 technology

Auto-Negotiation Expansion (Register 0.6)

This is the auto-negotiation expansion register indicating the status of the link partner's auto-negotiation. This register is valid only after the auto-negotiation is completed.

See also IEEE 802.3 28.2.4.1.5.

IEEE Standard Register=0.6

STD_AN_EXP

Auto-Negotiation Expansion (Register 0.6)

Reset Value

0064_H

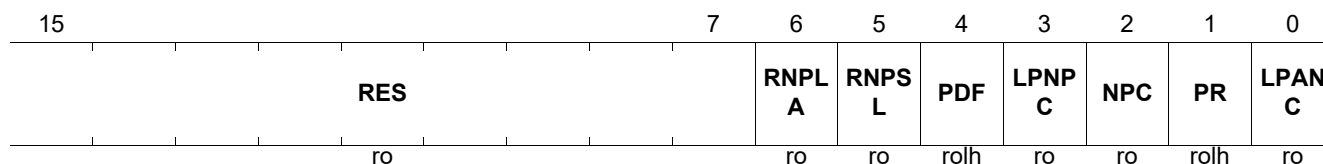

Field	Bits	Type	Description
RES	15:7	RO	Reserved Write as zero, ignore on read.
RNPLA	6	RO	Receive Next Page Location Able Per 802.3 - 2015, indicate that the Rx NP location is indicated by field RNPSL 0 _B UNABLE Received Next Page storage location is not specified by bit (6.5) 1 _B ABLE Received Next Page storage location is specified by bit (6.5)
RNPSL	5	RO	Receive Next Page Storage Location Per 802.3 - 2015, indicate that Rx NP is in register 0.8 for GPY 0 _B FIVE Link partner Next Pages are stored in Register 5 1 _B EIGHT Link partner Next Pages are stored in Register 8
PDF	4	ROLH	Parallel Detection Fault 0 _B NONE A fault has not been detected via the parallel detection function 1 _B FAULT A fault has been detected via the parallel detection function

Field	Bits	Type	Description (cont'd)
LPNPC	3	RO	Link Partner Next Page Capable 0 _B UNABLE Link partner is unable to exchange next pages 1 _B CAPABLE Link partner is capable of exchanging next pages
NPC	2	RO	Next Page Capable 0 _B UNABLE GPY is unable to exchange next pages 1 _B CAPABLE GPY is capable of exchanging next pages
PR	1	ROLH	Page Received 0 _B NONE A new page has not been received 1 _B RECEIVED A new page has been received
LPANC	0	RO	Link Partner Auto-Negotiation Capable 0 _B UNABLE Link partner is unable to auto-negotiate 1 _B CAPABLE Link partner is auto-negotiation capable

Auto-Negotiation Next Page Transmit Register (Register 0.7)

The auto-negotiation next page transmit register contains the next page link code word to be transmitted when next page ability is supported. See also IEEE 802.3 28.2.4.1.6.

IEEE Standard Register=0.7

STD_AN_NPTX

Reset Value

Auto-Negotiation Next Page Transmit Register (Register 0.7)

2001_H

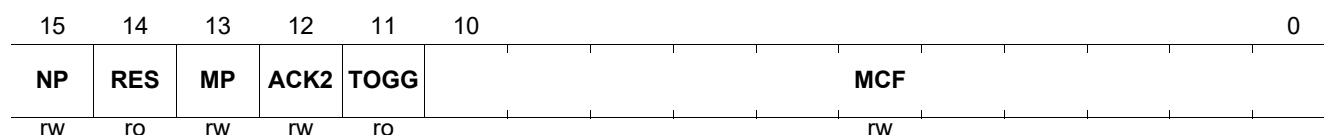

Field	Bits	Type	Description
NP	15	RW	Next Page 0 _B INACTIVE Last page 1 _B ACTIVE Additional next page(s) will follow
RES	14	RO	Reserved Write as zeroes, ignore on read.
MP	13	RW	Message Page Indicates that the content of MCF is either an unformatted page or a formatted message. 0 _B UNFOR Unformatted page 1 _B MESSG Message page
ACK2	12	RW	Acknowledge 2 0 _B INACTIVE Device cannot comply with message 1 _B ACTIVE Device will comply with message

Field	Bits	Type	Description (cont'd)
TOGG	11	RO	<p>Toggle This bit always takes the opposite value of the Toggle bit in the previously exchanged link code word. See also IEEE 802.3-2008 28.2.3.4. 0_B ZERO Previous value of the transmitted link code word was ONE 1_B ONE Previous value of the transmitted link code word was ZERO</p>
MCF	10:0	RW	<p>Message or Unformatted Code Field When Message Page bit is set to 1 (0.7.13), this field is the Message Code Field of a message page used in Next Page exchange. The message codes are described in IEEE802.3 Appendix 28C. It is used to indicate the type of message in UCF1 and UCF2. 0x0 = Reserved 0x1 = Null message 0x2 = One Unformatted Page (UP) with TAF follows 0x3 = Two UPs with TAF follows 0x4 = Remote fault details message 0x5 = OUI message 0x6 = PHY ID message 0x7 = 100BASE-T2 message 0x8 = 1000BASE-T message 0x9 = MULTIGBASE-T message 0xA = EEE technology capability follows in next UP 0xB = OUI XNP</p>

Auto-Negotiation Link Partner Received Next Page Register (Register 0.8)

The auto-negotiation link partner received next page register contains the next page link code word received from the link partner. See also IEEE 802.3-2008 28.2.4.1.7.

IEEE Standard Register=0.8

STD_AN_NPRX

Reset Value

Auto-Negotiation Link Partner Received Next Page Register (Register 0.8)

0000_H

15	14	13	12	11	10						0
NP	ACK	MP	ACK2	TOGG						MCF	
ro	ro	ro	ro	ro						rw	

Field	Bits	Type	Description
NP	15	RO	<p>Next Page See IEEE 802.3-2008 28.2.3.4. 0_B INACTIVE No next pages to follow 1_B ACTIVE Additional next page(s) will follow</p>

Field	Bits	Type	Description (cont'd)
ACK	14	RO	<p>Acknowledge See also IEEE 802.3-2008 28.2.3.4.</p> <p>0_B INACTIVE The device did not successfully receive its link partner's link code word</p> <p>1_B ACTIVE The device has successfully received its link partner's link code word</p>
MP	13	RO	<p>Message Page Indicates that the content of MCF is either an unformatted page or a formatted message. See also IEEE 802.3-2008 28.2.3.4.</p> <p>0_B UNFOR Unformatted page</p> <p>1_B MESSG Message page</p>
ACK2	12	RO	<p>Acknowledge 2 See also IEEE 802.3-2008 28.2.3.4.</p> <p>0_B INACTIVE Device cannot comply with message</p> <p>1_B ACTIVE Device will comply with message</p>
TOGG	11	RO	<p>Toggle This bit always takes the opposite value of the Toggle bit in the previously exchanged link code word. See also IEEE 802.3-2008 28.2.3.4.</p> <p>0_B ZERO Previous value of the transmitted link code word was equal to ONE</p> <p>1_B ONE Previous value of the transmitted link code word was equal to ZERO</p>
MCF	10:0	RW	<p>Message or Unformatted Code Field This field is the Message Code Field of a message page used in Next Page exchange. The message codes are described in IEEE802.3 Appendix 28C. It is used to indicate the type of message in UCF1 and UCF2.</p> <p>0x0 = Reserved 0x1 = Null message 0x2 = One Unformatted Page (UP) with TAF follows 0x3 = Two UPs with TAF follows 0x4 = Remote fault details message 0x5 = OUI message 0x6 = PHY ID message 0x7 = 100BASE-T2 message 0x8 = 1000BASE-T message 0x9 = MULTIGBASE-T message 0xA = EEE technology capability follows in next UP 0xB = OUI XNP</p>

Gigabit Control Register (Register 0.9)

This is the control register used to configure the Gigabit Ethernet behavior of the PHY. See also IEEE 802.3-2008 40.5.1.1.

IEEE Standard Register=0.9

STD_GCTRL

Reset Value

Gigabit Control Register (Register 0.9)

0200_H

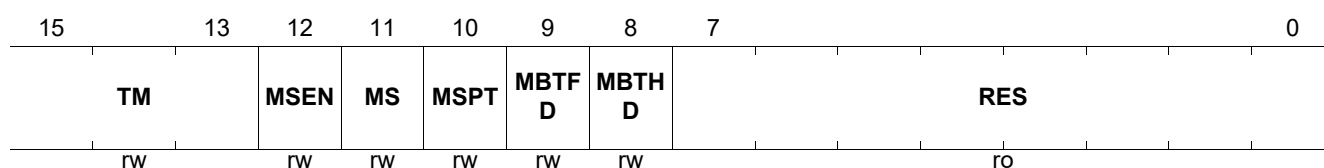

Field	Bits	Type	Description
TM	15:13	RW	Transmitter Test Mode This register field allows enabling of the standard transmitter test modes. See also IEEE 802.3-2008 Table 40-7. 000 _B NOP Normal operation 001 _B WAV Test mode 1 transmit waveform test 010 _B JITM Test mode 2 transmit jitter test in MASTER mode 011 _B JITS Test mode 3 transmit jitter test in SLAVE mode 100 _B DIST Test mode 4 transmitter distortion test
MSEN	12	RW	Master/Slave Manual Configuration Enable See also IEEE 802.3-2008 40.5.1.1. 0 _B DISABLED Disable master/slave manual configuration value 1 _B ENABLED Enable master/slave manual configuration value
MS	11	RW	Master/Slave Config Value Allows forcing of master or slave mode manually when AN_GCTRL.MSEN is set to logical one. See also IEEE 802.3-2008 40.5.1.1. 0 _B SLAVE Configure PHY as SLAVE during master/slave negotiation 1 _B MASTER Configure PHY as MASTER during master/slave negotiation
MSPT	10	RW	Master/Slave Port Type Defines whether the PHY advertises itself as a multi- or single-port device, which in turn impacts the master/slave resolution function. See also IEEE 802.3-2008 40.5.1.1. 0 _B SPD Single-port device 1 _B MPD Multi-port device
MBTFD	9	RW	1000BASE-T Full-Duplex Advertises the 1000BASE-T full-duplex capability; always forced to 1 in converter mode. See also IEEE 802.3-2008 40.5.1.1. 0 _B DISABLED Advertise PHY as not 1000BASE-T full-duplex capable 1 _B ENABLED Advertise PHY as 1000BASE-T full-duplex capable

Field	Bits	Type	Description (cont'd)
MBTHD	8	RW	1000BASE-T Half-Duplex Always advertises the 1000BASE-T half-duplex capability as disabled; GPY do not support 1000BASE-T Half-Duplex capability 0 _B DISABLED Advertise PHY as not 1000BASE-T half-duplex capable 1 _B ENABLED Advertise PHY as 1000BASE-T half-duplex capable
RES	7:0	RO	Reserved Write as zero, ignore on read.

Gigabit Status Register (Register 0.10)

This is the status register used to reflect the Gigabit Ethernet status of the PHY. See also IEEE 802.3-2008 40.5.1.1.

IEEE Standard Register=0.10

STD_GSTAT

Reset Value

Gigabit Status Register (Register 0.10)

0000_H

15	14	13	12	11	10	9	8	7													0
MSFA ULT	MSRE S	LRXS TAT	RRXS TAT	MBTF D	MBTH D	RES				IEC											
rwsc	ro	ro	ro	ro	ro	ro				rwsc											

Field	Bits	Type	Description
MSFAULT	15	RWSC	Master/Slave Manual Configuration Fault This bit will be set if the number of failed MASTER-SLAVE resolutions reaches 7 It is cleared upon each read of GSTAT. This bit self clears on auto-negotiation enable or auto-negotiation complete. 0 _B OK Master/slave manual configuration resolved successfully 1 _B NOK Master/slave manual configuration resolved with a fault
MSRES	14	RO	Master/Slave Configuration Resolution 0 _B SLAVE Local PHY configuration resolved to SLAVE 1 _B MASTER Local PHY configuration resolved to MASTER
LRXSTAT	13	RO	Local Receiver Status Indicates the status of the local receiver. See also IEEE 802.3-2008 40.5.1.1 register 10 in Table 40-3. 0 _B NOK Local receiver not OK 1 _B OK Local receiver OK
RRXSTAT	12	RO	Remote Receiver Status Indicates the status of the remote receiver. See also IEEE 802.3-2008 40.5.1.1 register 10 in Table 40-3. 0 _B NOK Remote receiver not OK 1 _B OK Remote receiver OK

Field	Bits	Type	Description (cont'd)
MBTFD	11	RO	Link Partner Capable of Operating 1000BASE-T Full-Duplex See also IEEE 802.3-2008 40.5.1.1 register 10 in Table 40-3. 0 _B DISABLED Link partner is not capable of operating 1000BASE-T full-duplex 1 _B ENABLED Link partner is capable of operating 1000BASE-T full-duplex
MBTHD	10	RO	Link Partner Capable of Operating 1000BASE-T Half-Duplex See also IEEE 802.3-2008 40.5.1.1 register 10 in Table 40-3. 0 _B DISABLED Link partner is not capable of operating 1000BASE-T half-duplex 1 _B ENABLED Link partner is capable of operating 1000BASE-T half-duplex
RES	9:8	RO	Reserved Write as zero, ignore on read.
IEC	7:0	RWSC	Idle Error Count Indicates the idle error count. This field contains a cumulative count of the errors detected when the receiver is receiving idles .

MMD Access Control Register (Register 0.13)

The MMD access control register is used in conjunction with the MMDDATA register to access the MMD register space. This uses address directing as specified in IEEE802.3 Clause 22 Extended.

IEEE Standard Register=0.13

STD_MMDCTRL

Reset Value

MMD Access Control Register (Register 0.13)

0000_H

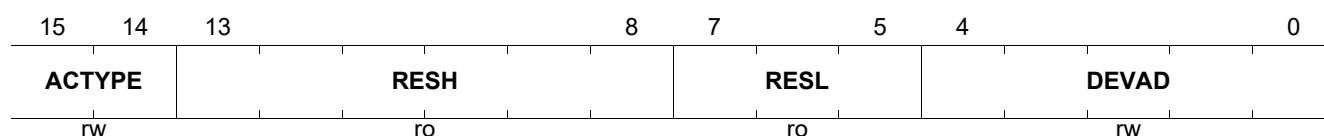

Field	Bits	Type	Description
ACTYPE	15:14	RW	Access Type Function If the access of register MMDDATA is an address access (ACTYPE=0) then it is directed to the address register within the MMD associated with the value in the DEVAD field. Otherwise, both the DEVAD field and the MMD's address register direct the register MMDDATA data accesses to the appropriate registers within that MMD. 00 _B ADDRESS Accesses to register MMDDATA access the MMD individual address register 01 _B DATA Accesses to register MMDDATA access the register within the MMD selected 10 _B DATA_PI Accesses to register MMDDATA access the register within the MMD selected 11 _B DATA_PIWR Accesses to register MMDDATA access the register within the MMD selected

Field	Bits	Type	Description (cont'd)
RESH	13:8	RO	Reserved Write as zero, ignored on read.
RESL	7:5	RO	Reserved Write as zero, ignored on read.
DEVAD	4:0	RW	Device Address The DEVAD field directs any accesses of register MMDDATA to the appropriate MMD as described in IEEE 802.3-2008 Clause 45.2.

MMD Access Data Register (Register 0.14)

The MMD access data register is used in conjunction with the MMD access control (MMDCTRL) register to access the MMD register space. For more information on MMD access, refer to IEEE 802.3-2008 Clause 22.2.4.3.12, Clause 45.2 and Annex 22D.

IEEE Standard Register=0.14

STD_MMDDATA **Reset Value**
MMD Access Data Register (Register 0.14) **0000_H**

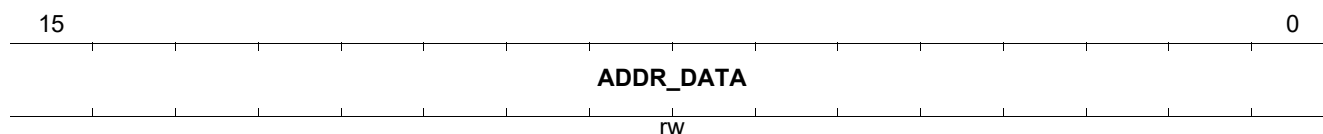

Field	Bits	Type	Description
ADDR_DATA	15:0	RW	Address or Data Register This register accesses either a specific MMD address register or the data content of the MMD register to which this address register points. Which of the functions is currently valid is defined by the MMDCTRL register.

Extended Status Register (Register 0.15)

This register contains extended status and capability information about the PHY. Note that all bits are read-only. A write access does not have any effect.

IEEE Standard Register=0.15

STD_XSTAT **Reset Value**
Extended Status Register (Register 0.15) **2000_H**

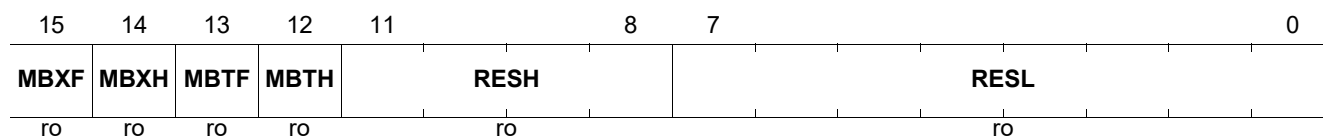

Field	Bits	Type	Description
MBXF	15	RO	1000BASE-X Full-Duplex Capability Specifies whether the PHY is capable of operating 1000BASE-X full-duplex. 0 _B DISABLED PHY does not support this mode 1 _B ENABLED PHY supports this mode
MBXH	14	RO	1000BASE-X Half-Duplex Capability Specifies whether the PHY is capable of operating 1000BASE-X half-duplex. 0 _B DISABLED PHY does not support this mode 1 _B ENABLED PHY supports this mode
MBTF	13	RO	1000BASE-T Full-Duplex Capability Specifies whether the PHY is capable of operating 1000BASE-T full-duplex. 0 _B DISABLED PHY does not support this mode 1 _B ENABLED PHY supports this mode
MBTH	12	RO	1000BASE-T Half-Duplex Capability GPY do not support 1000BASE-T Half-Duplex capability. 0 _B DISABLED PHY does not support this mode 1 _B ENABLED PHY supports this mode
RESH	11:8	RO	Reserved Ignore when read.
RESL	7:0	RO	Reserved Ignore when read.

5.2 GPY-specific Management Registers

This section describes the GPY specific management registers in device 0.

Table 19 Registers Overview

Register Short Name	Register Long Name	Reset Value
PHY_STAT1	Physical Layer Status 1 (Register 0.17)	0000 _H
PHY_CTL1	Physical Layer Control 1 (Register 0.19)	0001 _H
PHY_CTL2	Physical Layer Control 2 (Register 0.20)	0006 _H
PHY_ERRCNT	Error Counter (Register 0.21)	0000 _H
PHY_MIISTAT	Media-Independent Interface Status (Register 0.24)	0000 _H
PHY_IMASK	Interrupt Mask Register (Register 0.25)	0000 _H
PHY_ISTAT	Interrupt Status Register (Register 0.26)	0000 _H
PHY_LED	LED Control Register (Register 0.27)	FF00 _H
PHY_FWV	Firmware Version Register (Register 0.30)	0000 _H

5.2.1 GPY-specific Management Registers

This chapter describes all registers of PHY in detail.

Physical Layer Status 1 (Register 0.17)

This register reports PHY link information, for example link-up, polarity reversals and port mapping. The content of this register is only valid when the link is up.

IEEE Standard Register=0.17

PHY_STAT1 **Reset Value**
0000_H
Physical Layer Status 1 (Register 0.17)

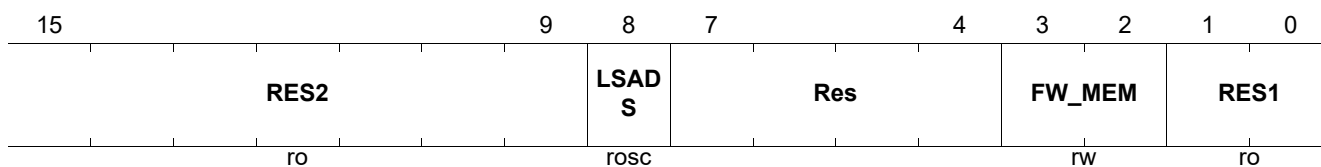

Field	Bits	Type	Description
RES2	15:9	RO	Reserved Write as zero, ignored on read.
LSADS	8	ROSC	Link Speed Auto-Downspeed Status Monitors the status of the auto-downspeed. 0 _B NORMAL Did not perform any link speed auto-downspeed 1 _B DETECTED Detected an auto-downspeed

Field	Bits	Type	Description (cont'd)
FW_MEM	3:2	RW	Firmware Memory Location Indicate memory target used for firmware execution 00 _B ROM Firmware is executed from ROM 01 _B OTP Firmware is executed from OTP 10 _B FLASH Firmware is executed from FLASH 11 _B RAM Firmware is executed from SRAM
RES1	1:0	RO	Reserved Write as zero, ignored on read.

Physical Layer Control 1 (Register 0.19)

This register controls the PHY functions.

IEEE Standard Register=0.19

PHY_CTL1

Reset Value

Physical Layer Control 1 (Register 0.19)

0001_H

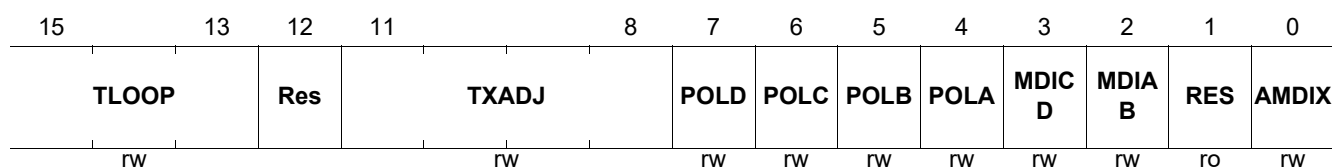

Field	Bits	Type	Description
TLOOP	15:13	RW	Test Loop Configures predefined test loops. 000 _B OFF Test loops are switched off - normal operation. 001 _B NETL Near-end test loop 010 _B Far-end test loop Others: Reserved
TXADJ	11:8	RW	Transmit Level Adjustment Transmit-level adjustment is used to fine tune the transmit amplitude of the PHY. The amplitude adjustment is valid for all supported speed modes. The adjustment is performed in digits. One digit represents 3.125 percent of the nominal amplitude. The scaling factor is gain = 1 + signed(TXADJ)*2 ⁻⁷ .
POLD	7	RW	Polarity Inversion Control on Port D 0 _B NORMAL Polarity normal 1 _B INVERTED Polarity inversion
POLC	6	RW	Polarity Inversion Control on Port C 0 _B NORMAL Polarity normal 1 _B INVERTED Polarity inversion
POLB	5	RW	Polarity Inversion Control on Port B 0 _B NORMAL Polarity normal 1 _B INVERTED Polarity inversion

Field	Bits	Type	Description (cont'd)
POLA	4	RW	Polarity Inversion Control on Port A 0 _B NORMAL Polarity normal 1 _B INVERTED Polarity inversion
MDICD	3	RW	Mapping of MDI Ports C and D Used when Auto-MDIX is OFF, to force the MDIX cable crossover configuration 0 _B MDI Normal MDI mode 1 _B MDIX Crossover MDI-X mode
MDIAB	2	RW	Mapping of MDI Ports A and B Used when Auto-MDIX is OFF, to force the MDIX cable crossover configuration 0 _B MDI Normal MDI mode 1 _B MDIX Crossover MDI-X mode
RES	1	RO	Reserved
AMDIX	0	RW	PHY Performs Auto-MDI/MDI-X or Uses Manual MDI/MDI-X 0 _B MANUAL PHY uses manual MDI/MDI-X 1 _B AUTO PHY performs Auto-MDI/MDI-X

Physical Layer Control 2 (Register 0.20)

This register controls the PHY functions.

IEEE Standard Register=0.20

PHY_CTL2

Reset Value

Physical Layer Control 2 (Register 0.20)

0006_H

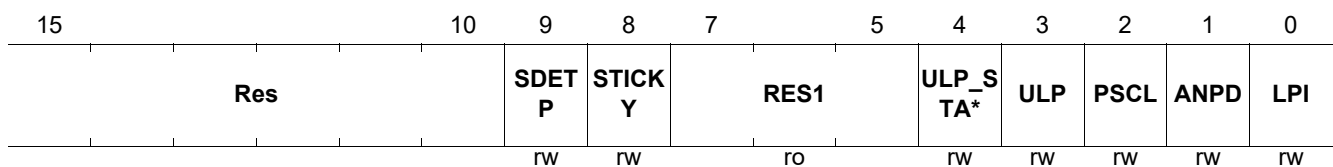

Field	Bits	Type	Description
SDETP	9	RW	Signal Detection Polarity for the 1000BASE-X PHY Allows specification of the signal detection polarity of the SIGDET input. Although this bit is reset to 0, its actual value depends on the pin-strapping configuration if no EEPROM is detected. 0 _B LOWACTIVE SIGDET input is low active 1 _B HIGHACTIVE SIGDET input is high active
STICKY	8	RW	Sticky-Bit Handling Setting this bit to 1 ensures that all the vendor specific registers (of type RW) in PHY (device 0), VSPEC1 (device 30) and VSPEC2 (device 31) are not changed during a MDIO reset or software reset of GPY. This allows the STA to keep the configurations chosen before reset. 0 _B OFF Sticky-bit handling is disabled 1 _B ON Sticky-bit handling is enabled

Field	Bits	Type	Description (cont'd)
RES1	7:5	RO	Reserved Write as zero, ignored on read.
ULP_STA_BLOCK	4	RW	Ultra Low Power Mode entry block by acknowledgment from STA Ultra Low Power Mode entry block by acknowledgment from STA When PHY_IMASK.ULP = ACTIVE, intent to ULP entry is indicated to STA. For the GPY to enter unconditionally without acknowledgement from STA, set PHY_CTL2.ULP_STA_BLOCK = OFF. For blocking ULP entry till the acknowledgement is received from STA, set PHY_CTL2.ULP_STA_BLOCK = ON. This bit has no effect when PHY_IMASK.ULP = INACTIVE. 0 _B OFF ULP Entry without the role of STAGPY will enter ULP unconditionally without acknowledgement from STA 1 _B ON ULP Entry Blocked by STAGPY will enter ULP only after STA reads the ULP interrupt status register PHY_ISTAT
ULP	3	RW	Ultra Low Power Mode Ultra Low Power Mode (ULP) allows GPY to save energy by disabling most of the digital logic to reduce power consumption to its lowest level. The entry to ULP is triggered when the PHY does not sense any energy on the cable and that no Link pulses (NLP, FLP, Beacons) are received. After spending VSPEC1_NBT_DS_CTRL.NRG_RST_CNT without energy in the ABILITY_DETECT state defined by IEEE802.3 Clause 28, the PHY enters ULP. 0 _B OFF ULP is DisabledGPY will not never enter ULP. 1 _B ON ULP is EnabledGPY will enter ULP is no energy
PSCL	2	RW	Power Consumption Scaling Depending on Link Quality Allows enabling/disabling of the power consumption scaling dependent on the link quality. 0 _B OFF PSCL is disabled 1 _B ON PSCL is enabled
ANPD	1	RW	Auto-Negotiation Power Down Allows enabling/disabling of the power down modes during auto-negotiation looking for a link partner. 0 _B OFF ANPD is disabled 1 _B ON ANPD is enabled
LPI	0	RW	Assert LPI via MDIO Controls Asserts/de-asserts of LPI by MDIO instead of following (X)GMII LPI Used to force the EEE on the TPI (ignoring the LPI indication from MAC) 0 _B DEASSERT LPI is de-asserted TPI 1 _B ASSERT LPI is asserted on TPI

Error Counter (Register 0.21)

This register controls the error counter. It allows the number of errors detected in the PHY to be counted for monitoring purposes.

IEEE Standard Register=0.21

PHY_ERRCNT

Reset Value

Error Counter (Register 0.21)

0000_H

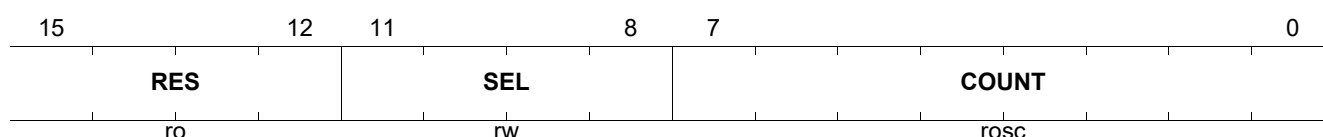

Field	Bits	Type	Description
RES	15:12	RO	Reserved Write as zero, ignored on read.
SEL	11:8	RW	Select Error Event Configures which error type the error counter counts 0000 _B RXERR Receive errors are counted 0001 _B RXACT Receive frames are counted 0010 _B ESDERR ESD errors are counted 0011 _B SSDERR SSD errors are counted 0100 _B TXERR Transmit errors are counted 0101 _B TXACT Transmit frames events get counted 0110 _B COL Collision events get counted 1000 _B NLD Number of Link Down events get counted 1001 _B NDS Number of auto-downspeed events get counted 1010 _B CRC CRC counter 1011 _B TTL Time to Link
COUNT	7:0	ROSC	Counter Value This counter value is updated each time the selected error event has been detected. The counter value is reset every time a read operation on this register is performed or the error event is changed. The counter saturates at value 0xFF.

Media-Independent Interface Status (Register 0.24)

This register contains status information on the Ethernet link, concatenated in a single register to allow concise status read by the STA in a single register.

IEEE Standard Register=0.24

PHY_MIISTAT

Reset Value

Media-Independent Interface Status (Register 0.24)

0000_H

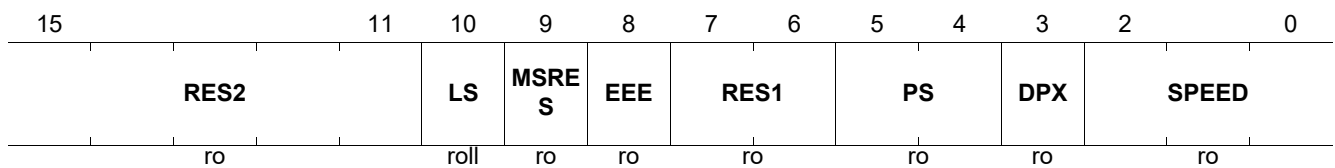

Field	Bits	Type	Description
RES2	15:11	RO	Reserved Write as zero, ignored on read.
LS	10	ROLL	Link Status at which GPY Ethernet PHY Operates Indicates the link status of the PHY 0 _B INACTIVE The link is down.No communication with link partner possible. 1 _B ACTIVE The link is up.Data communication with link partner is possible.
MSRES	9	RO	Master/Slave Configuration Master/Slave Configuration 0 _B SLAVE Local PHY configuration is SLAVE after ANEG 1 _B MASTER Local PHY configuration is MASTER after ANEG
EEE	8	RO	Energy-Efficient Ethernet Mode 0 _B OFF EEE is disabled after auto-negotiation resolution 1 _B ON EEE is enabled after auto-negotiation resolution
RES1	7:6	RO	Reserved
PS	5:4	RO	Pause Status for Flow Control 00 _B NONE No PAUSE 01 _B TX Transmit PAUSE 10 _B RX Receive PAUSE 11 _B TXX Both transmit and receive PAUSE
DPX	3	RO	GPY Ethernet PHY Duplex Mode 0 _B HDX Half duplex 1 _B FDX Full duplex
SPEED	2:0	RO	GPY Ethernet PHY Speed GPY doesn't support 2.5G speed as this is 1G product 000 _B TEN 10 Mbit/s 001 _B FAST 100 Mbit/s 010 _B GIGA 1000 Mbit/s 011 _B ANEG Autonegotiation mode 100 _B BZZG5 2.5Gbit/s

Interrupt Mask Register (Register 0.25)

This register defines the mask for the Interrupt Status Register (ISTAT) which contains the event source for the MDINT interrupt sent from GPY to an external chip.

The information about the interrupt source is indicated in the ISTAT register.

IEEE Standard Register=0.25

PHY_IMASK

Reset Value

Interrupt Mask Register (Register 0.25)

0000_H

15	14	13	12	11	10	9	8	7	6	5	4	3	2	1	0
WOL	MSRE	NPRX	NPTX	ANE	ANC	Res	LOR	ULP	TEMP	ADSC	MDIPC	MDIXC	DXMC	LSPC	LSTC
<small>RW</small>	<small>RW</small>	<small>RW</small>	<small>RW</small>	<small>RW</small>	<small>RW</small>		<small>RW</small>	<small>RW</small>	<small>RW</small>	<small>RW</small>	<small>RW</small>	<small>RW</small>	<small>RW</small>	<small>RW</small>	<small>RW</small>

Field	Bits	Type	Description
WOL	15	RW	<p>Wake-on-LAN Event Mask When active and masked in IMASK, the MDINT is activated upon detection of a valid Wake-on-LAN event.</p> <p>0_B INACTIVE Interrupt is masked out 1_B ACTIVE Interrupt is activated</p>
MSRE	14	RW	<p>Master/Slave Resolution Error Mask When active, MDINT is activated upon detection of a master/slave resolution error during a 1000BASE-T auto-negotiation.</p> <p>0_B INACTIVE Interrupt is masked out 1_B ACTIVE Interrupt is activated</p>
NPRX	13	RW	<p>Next Page Received Mask When active, MDINT is activated upon reception of a next page in STD.AN_NPRX.</p> <p>0_B INACTIVE Interrupt is masked out 1_B ACTIVE Interrupt is activated</p>
NPTX	12	RW	<p>Next Page Transmitted Mask When active, MDINT is activated upon transmission of the currently stored next page in STD.AN_NPTX.</p> <p>0_B INACTIVE Interrupt is masked out 1_B ACTIVE Interrupt is activated</p>
ANE	11	RW	<p>Auto-Negotiation Error Mask When active, MDINT is activated upon detection of an auto-negotiation error.</p> <p>0_B INACTIVE Interrupt is masked out 1_B ACTIVE Interrupt is activated</p>
ANC	10	RW	<p>Auto-Negotiation Complete Mask When active, MDINT is activated upon completion of the auto-negotiation process.</p> <p>0_B INACTIVE Interrupt is masked out 1_B ACTIVE Interrupt is activated</p>

Field	Bits	Type	Description (cont'd)
LOR	8	RW	<p>SyncE Lost Of Reference When active, MDINT is activated upon loss of SyncE reference clock.</p> <p>0_B INACTIVE Interrupt is masked out 1_B ACTIVE Interrupt is activated</p>
ULP	7	RW	<p>ULP Entry Indication Mask 0_B INACTIVE Interrupt is masked out STA does not need to be informed of the event 1_B ACTIVE Interrupt is activated STA receives MDINT when PHY is about to enter ULPT Then the condition to ULP Entry to is based on PHY_CTL2.ULP_STA_BLOCK.</p>
TEMP	6	RW	<p>TEMP 0_B INACTIVE Interrupt is masked out STA does not require to be informed of the event 1_B ACTIVE Interrupt is activated Interrupt is raised when temperature goes beyond Normal Operating Range</p>
ADSC	5	RW	<p>Link Speed Auto-Downspeed Detect Mask When active, MDINT is activated upon detection of a link speed auto-downspeed event.</p> <p>0_B INACTIVE Interrupt is masked out 1_B ACTIVE Interrupt is activated</p>
MDIPC	4	RW	<p>MDI Polarity Change Detect Mask When active, MDINT is activated upon detection of an MDI polarity change event.</p> <p>0_B INACTIVE Interrupt is masked out 1_B ACTIVE Interrupt is activated</p>
MDIXC	3	RW	<p>MDIX Change Detect Mask When active, MDINT is activated upon detection of an MDI/MDIX cross-over change event.</p> <p>0_B INACTIVE Interrupt is masked out 1_B ACTIVE Interrupt is activated</p>
DXMC	2	RW	<p>Duplex Mode Change Mask When active, MDINT is activated upon detection of full- or half-duplex change.</p> <p>0_B INACTIVE Interrupt is masked out 1_B ACTIVE Interrupt is activated</p>
LSPC	1	RW	<p>Link Speed Change Mask When active, MDINT is activated upon detection of link speed change.</p> <p>0_B INACTIVE Interrupt is masked out 1_B ACTIVE Interrupt is activated</p>
LSTC	0	RW	<p>Link State Change Mask When active, MDINT is activated upon detection of link status change.</p> <p>0_B INACTIVE Interrupt is masked out 1_B ACTIVE Interrupt is activated</p>

Interrupt Status Register (Register 0.26)

This register defines the event source for the MDINT interrupt sent from GPY to an external chip.

PHY_ISTAT is a cleared on read by the STA.

IEEE Standard Register=0.26

PHY_ISTAT

Reset Value

Interrupt Status Register (Register 0.26)

0000_H

15	14	13	12	11	10	9	8	7	6	5	4	3	2	1	0
WOL	MSRE	NPRX	NPTX	ANE	ANC	Res	LOR	ULP	TEMP	ADSC	MDIPC	MDIXC	DXMC	LSPC	LSTC
rosc	rosc	rosc	rosc	rosc	rosc		rosc	rosc	rosc	rosc	rosc	rosc	rosc	rosc	rosc

Field	Bits	Type	Description
WOL	15	ROSC	<p>Wake-on-LAN Interrupt Status</p> <p>When bit is set, the MDINT is activated upon detection of a valid Wake-on-LAN event.</p> <p>0_B INACTIVE This event is not the interrupt source</p> <p>1_B ACTIVE WoL event is the source of the interrupt</p>
MSRE	14	ROSC	<p>Master/Slave Resolution Error Interrupt Status</p> <p>When bit is set, the MDINT is activated upon detection of a master/slave resolution error during a 1000BASE-T auto-negotiation.</p> <p>0_B INACTIVE This event is not the interrupt source</p> <p>1_B ACTIVE MSRE event is the source of the interrupt</p>
NPRX	13	ROSC	<p>Next Page Received Interrupt Status</p> <p>When bit is set, the MDINT is activated upon reception of a next page in STD.AN_NPRX.</p> <p>0_B INACTIVE This event is not the interrupt source</p> <p>1_B ACTIVE NPTX event is the source of the interrupt</p>
NPTX	12	ROSC	<p>Next Page Transmitted Interrupt Status</p> <p>When bit is set, the MDINT is activated upon transmission of the currently stored next page in STD.AN_NPTX.</p> <p>0_B INACTIVE This event is not the interrupt source</p> <p>1_B ACTIVE NPTX event is the source of the interrupt</p>
ANE	11	ROSC	<p>Auto-Negotiation Error Interrupt Status</p> <p>When bit is set, the MDINT is activated upon detection of an auto-negotiation error.</p> <p>0_B INACTIVE This event is not the interrupt source</p> <p>1_B ACTIVE ANEG error event is the source of the interrupt</p>
ANC	10	ROSC	<p>Auto-Negotiation Complete Interrupt Status</p> <p>When bit is set, the MDINT is activated upon completion of the auto-negotiation process.</p> <p>0_B INACTIVE This event is not the interrupt source</p> <p>1_B ACTIVE ANEG complete event is the source of the interrupt</p>

Field	Bits	Type	Description (cont'd)
LOR	8	ROSC	<p>SyncE Lost Of Reference When bit is set, MDINT is activated upon loss of SyncE reference clock.</p> <p>0_B INACTIVE This event is not the interrupt source 1_B ACTIVE LOR Change event is the source of the interrupt</p>
ULP	7	ROSC	<p>ULP Entry Indication 0_B INACTIVE No indication of ULP entry 1_B ACTIVE Indication of ULP EntryEntry to ULP is delayed until the STA has read PHY_ISTAT or not is based on PHY_CTL2.ULP_STA_BLOCK.</p>
TEMP	6	ROSC	<p>TEMP Indicate a Thermal Mitigation action must be taken when the temperature goes beyond Operating Range. It is recommended that the SoC initiates a link-down and change speed capability to reduce go back to normal thermal Range. When the temperature reaches the Maximum Absolute Ratings, the GPY resets for safety purpose. Thermal mitigation must ensure that the temperature maximum absolute ratings are never reached.</p> <p>0_B INACTIVE This event is not the interrupt source 1_B ACTIVE TEMP Change event is the source of the interrupt</p>
ADSC	5	ROSC	<p>Link Speed Auto-Downspeed Detect Interrupt Status When bit is set, the MDINT is activated upon detection of a link speed auto-downspeed event.</p> <p>0_B INACTIVE This event is not the interrupt source 1_B ACTIVE ADSC Change event is the source of the interrupt</p>
MDIPC	4	ROSC	<p>MDI Polarity Change Detect Interrupt Status When bit is set, the MDINT is activated upon detection of an MDI polarity change event.</p> <p>0_B INACTIVE This event is not the interrupt source 1_B ACTIVE MDIPC Change event is the source of the interrupt</p>
MDIXC	3	ROSC	<p>MDIX Change Detect Interrupt Status When bit is set, the MDINT is activated upon detection of an MDI/MDIX cross-over change event.</p> <p>0_B INACTIVE This event is not the interrupt source 1_B ACTIVE MDIX Change event is the source of the interrupt</p>
DXMC	2	ROSC	<p>Duplex Mode Change Interrupt Status When bit is set, the MDINT is activated upon detection of a full or half-duplex change.</p> <p>0_B INACTIVE This event is not the interrupt source 1_B ACTIVE Duplex Mode Change event is the source of the interrupt</p>
LSPC	1	ROSC	<p>Link Speed Change Interrupt Status When bit is set, the MDINT is activated upon detection of link speed change.</p> <p>0_B INACTIVE This event is not the interrupt source 1_B ACTIVE Link Speed Change event is the source of the interrupt</p>

Field	Bits	Type	Description (cont'd)
LSTC	0	ROSC	<p>Link State Change Interrupt Status When bit is set, the MDINT is activated upon detection of link status change.</p> <p>0_B INACTIVE This event is not the interrupt source 1_B ACTIVE Link State Change event is the source of the interrupt</p>

LED Control Register (Register 0.27)

This register contains control bits for direct access to the LEDs by setting the on/off LEDxA bits (with x from 0 to 4). To directly control the LED, the integrated LED functions must be disabled by the LEDxEN bit in this register. The integrated LED functions are specified in the more sophisticated LED control registers in MMD device VSPEC1.

IEEE Standard Register=0.27

PHY_LED

Reset Value

LED Control Register (Register 0.27)

FF00_H

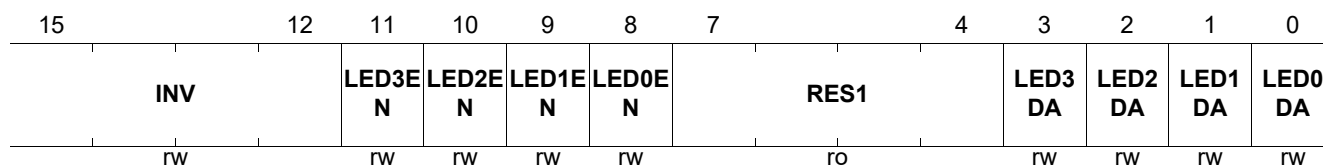

Field	Bits	Type	Description
INV	15:12	RW	<p>Invert LED Output This provide a per LED control to invert the output of the LEDs. set to '1' to support LEDs which are driven by VDDs. Set to '0' to support LEDs which are driven by the output pins of this product.</p>
LED3EN	11	RW	<p>Enable Integrated Function of LED3 Write a 0 to this bit to disable the pre-configured integrated function for this LED. The LED remains off unless directly accessed via LED3DA. 0_B DISABLE Disables the integrated LED function 1_B ENABLE Enables the integrated LED function</p>
LED2EN	10	RW	<p>Enable Integrated Function of LED2 Write a 0 to this bit to disable the pre-configured integrated function for this LED. The LED remains off unless directly accessed via LED2DA. 0_B DISABLE Disables the integrated LED function 1_B ENABLE Enables the integrated LED function</p>
LED1EN	9	RW	<p>Enable Integrated Function of LED1 Write a 0 to this bit to disable the pre-configured integrated function for this LED. The LED remains off unless directly accessed via LED1DA. 0_B DISABLE Disables the integrated LED function 1_B ENABLE Enables the integrated LED function</p>

Field	Bits	Type	Description (cont'd)
LED0EN	8	RW	Enable Integrated Function of LED0 Write a 0 to this bit to disable the pre-configured integrated function for this LED. The LED remains off unless directly accessed via LED0DA. 0 _B DISABLE Disables the integrated LED function 1 _B ENABLE Enables the integrated LED function
RES1	7:4	RO	Reserved Write as zero, ignored on read.
LED3DA	3	RW	Direct Access to LED3 Write a 1 to this bit to illuminate the LED. Note that LED3EN must be set to zero. 0 _B OFF Switch off the LED 1 _B ON Switch on the LED
LED2DA	2	RW	Direct Access to LED2 Write a 1 to this bit to illuminate the LED. Note that LED2EN must be set to zero. 0 _B OFF Switch off the LED 1 _B ON Switch on the LED
LED1DA	1	RW	Direct Access to LED1 Write a 1 to this bit to illuminate the LED. Note that LED1EN must be set to zero. 0 _B OFF Switch off the LED 1 _B ON Switch on the LED
LED0DA	0	RW	Direct Access to LED0 Write a 1 to this bit to illuminate the LED. Note that LED0EN must be set to zero. 0 _B OFF Switch off the LED 1 _B ON Switch on the LED

Firmware Version Register (Register 0.30)

This register contains the version of the PHY firmware. The version number is initialized at boot time by the firmware with its current software version. This register is read-only by the external STA.

IEEE Standard Register=0.30

PHY_FWV

Firmware Version Register (Register 0.30)

Reset Value

0000_H

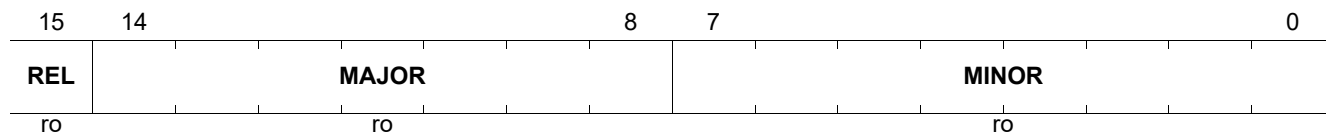

Field	Bits	Type	Description
REL	15	RO	Release Indication This parameter indicates either a test or a release version. 0 _B TEST Indicates a test version 1 _B RELEASE Indicates a released version
MAJOR	14:8	RO	Major Version Number Specifies the main version release number of the firmware.
MINOR	7:0	RO	Minor Version Number Specifies the sub-version release number of the firmware.

Internal Test Modes CDIAG and ABIST (Register 0.31)

This is the control register used to configure the Gigabit Ethernet behavior of the PHY. See also IEEE 802.3-2008 40.5.1.1.

IEEE Standard Register=0.31

PHY_TEST

Reset Value

Internal Test Modes CDIAG and ABIST (Register 0.31)

0000_H

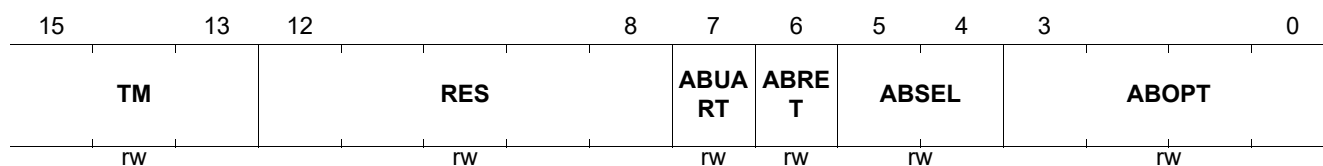

Field	Bits	Type	Description
TM	15:13	RW	Proprietary Test Modes ABIST and CDIAG Enter the test mode. Any value different from 6 or 7 has no effect. 110 _B CDIAG GPY specificCable Diagnostic 111 _B ABIST GPY specificAnalog build in self-test
RES	12:8	RW	Reserved
ABUART	7	RW	ABIST UART output for debug If set to 1, enable detail report on the debug UART output. This is used to debug the feature and not in production mode, because in that case the 2 LED signals are not used to indicate completion or pass fail. An alternative to UART is to read the STB via MDIO commands. 0 _B NORMAL ABIST normal output 1 _B UART ABIST output to UART
ABRET	6	RW	ABIST ReTrig If set to 1, enable restart of the selected ABIST test. This is used to debug the feature and not in production mode 0 _B NORMAL Normal Mode 1 _B RETRIG Restart the current ABIST Test

Field	Bits	Type	Description (cont'd)
ABSEL	5:4	RW	ABIST sub-mode selection 00B, ABIST Analog Tests 01B, ABIST DC tests 10B, reserved 11B, reserved 00 _B ANALOG ABIST Analog Tests 01 _B DC ABIST DC Tests
ABOPT	3:0	RW	ABIST Option for DC test In ABIST DC test 0000, ABIST DC test for 10BT mode LD, max positive differential level 0001, ABIST DC test for 1000BT mode LD, max positive differential level 0010, ABIST DC test for 10BT mode LD, 0 differential level 0011, ABIST DC test for 1000BT mode LD, 0 differential level 0100, ABIST DC test for 10BT mode LD, max negative differential level 0101, ABIST DC test for 1000BT mode LD, max negative differential level 0110, ABIST DC test for 2500BT mode LD, max positive differential level 0111, ABIST DC test for 2500BT mode LD, 0 differential level 1000, ABIST DC test for 2500BT mode LD, max negative differential level

6 MMD Registers Detailed Description

Table 20 Register Access Type

Mode	Symbol
Status Register, (Status, or Ability Register)	RO
Read-Write Register, (e.g. MDIO Register)	RW
Read-Write, Self-Clearing Register (bit is cleared after read from MDIO)	RWSC

Attention: As GPY115 is a 1G speed product, the maximum speed capability available in the registers is 1G. Any speed request higher than 1G (2.5G, 5G, 10G) defaults to 1G.

6.1 Standard PMAPMD Registers for MMD=0x01

Table 21 Registers Overview

Register Short Name	Register Long Name	Reset Value
PMA_CTRL1	PMA/PMD Control 1 (Register 1.0)	0058 _H
PMA_STAT1	PMA/PMD status 1 (Register 1.1)	0000 _H
PMA_DEVID1	PHY Identifier 1 (Register 1.2)	67C9 _H
PMA_DEVID2	PHY Identifier 2 (Register 1.3)	DC00 _H ¹⁾
PMA_SPEED_ABILITY	PMA/PMD speed ability (Register 1.4)	0070 _H
PMA_DIP1	Devices in package 1 (Register 1.5)	008B _H
PMA_DIP2	Devices in package 2 (Register 1.6)	C000 _H
PMA_CTL2	PMA/PMD control 2 (Register 1.7)	0030 _H
PMA_STAT2	PMA/PMD status 2 (Register 1.8)	8200 _H
PMA_EXT_ABILITY	PMA/PMD Extended Ability (Register 1.11)	01A0 _H
PMA_PACKID1	AN package identifier (Register 1.14)	67C9 _H
PMA_PACKID2	AN package identifier (Register 1.15)	DC00 _H ¹⁾
PMA_MGBT_EXTAB	PMAPMD Extended Ability (Register 1.21)	0000 _H
PMA_MGBT_POLARITY	MULTIGBASE-T pair swap and polarity (Register 1.130)	0003 _H
PMA_MGBT_TX_PBO	MULTIGBASE-T TX power backoff and PHY short reach setting (Register 1.131)	0000 _H
PMA_MGBT_TEST_MODE	MULTIGBASE-T test mode (Register 1.132)	0000 _H
PMA_MGBT_SNR_OPMARGIN_A	MULTIGBASE-T SNR Margin Channel A (Register 1.133)	0000 _H
PMA_MGBT_SNR_OPMARGIN_B	MULTIGBASE-T SNR Margin Channel B (Register 1.134)	0000 _H
PMA_MGBT_SNR_OPMARGIN_C	MULTIGBASE-T SNR Margin Channel C (Register 1.135)	0000 _H
PMA_MGBT_SNR_OPMARGIN_D	MULTIGBASE-T SNR Margin Channel D (Register 1.136)	0000 _H
PMA_MGBT_MINMARGIN_A	MULTIGBASE-T SNR Min Margin Channel A (Register 1.137)	0000 _H
PMA_MGBT_MINMARGIN_B	MULTIGBASE-T SNR Min Margin Channel B (Register 1.138)	0000 _H
PMA_MGBT_MINMARGIN_C	MULTIGBASE-T SNR Min Margin Chan C (Register 1.139)	0000 _H
PMA_MGBT_MINMARGIN_D	MULTIGBASE-T SNR Min Margin Chan D (Register 1.140)	0000 _H
PMA_MGBT_POWER_A	MULTIGBASE-T Rx Power Channel A (Register 1.141)	0000 _H
PMA_MGBT_POWER_B	MULTIGBASE-T Rx Power Channel B (Register 1.142)	0000 _H

Table 21 Registers Overview (cont'd)

Register Short Name	Register Long Name	Reset Value
PMA_MGBT_POWER_C	MULTIGBASE-T Rx Power Chan C (Register 1.143)	0000 _H
PMA_MGBT_POWER_D	MULTIGBASE-T Rx Power Chan D (Register 1.144)	0000 _H
PMA_MGBT_SKEW_DELAY_0	MULTIGBASE-T skew delay 0 (Register 1.145)	0000 _H
PMA_MGBT_SKEW_DELAY_1	MULTIGBASE-T skew delay 1 (Register 1.146)	0000 _H
PMA_MGBT_FAST_RETRAIN_STA_CTRL	MULTIGBASE-T skew delay 2 (Register 1.147)	0000 _H
PMA_TIMESYNC_CAP	PMA TimeSync Capability Indication (Register 1.1800)	0000 _H

1) For the device specific reset value, refer to Product Naming table in the [Package Outline](#) chapter.

6.1.1 Standard PMAPMD Registers for MMD=0x01

This chapter describes all registers of PMAPMD in detail.

PMA/PMD Control 1 (Register 1.0)

IEEE Standard Register=1.0

PMA_CTRL1

PMA/PMD Control 1 (Register 1.0)

										Reset Value	
										0058 _H	
15	14	13	12	11	10	7	6	5	2	1	0
RST	Res	SSL	Res	LOW_POWER*	Res		SSM	SPEED_SEL		NS1	NS2
rw		rw		rw			rw	rw		ro	ro

Field	Bits	Type	Description
RST	15	RW	Reset 1 = PMA/PMD reset 0 = Normal operation
SSL	13	RW	Speed Selection (LSB) Used in conjunction with field SPEED_SEL_MSB MSB LSB: 1 1 = bits 5:2 are used to select speed (SPEED_SEL field) 1 0 = 1000 Mb/s 0 1 = 100 Mb/s 0 0 = 10 Mb/s
LOW_POWER	11	RW	Low power 1 = Enter Low power mode 0 = Normal operation

Field	Bits	Type	Description (cont'd)
SSM	6	RW	Speed Selection (MSB) Used in conjunction with field SPEED_SEL_LSB MSB LSB: 1 1 = bits 5:2 select speed (SPEED_SEL field) 1 0 = 1000 Mb/s 0 1 = 100 Mb/s 0 0 = 10 Mb/s
SPEED_SEL	5:2	RW	Speed Selection Reserved 0110 _B S2G5 Forced Speed is 2G5
NS1	1	RO	Not Supported PMA remote loop-back mode is not supported by GPY
NS2	0	RO	Not Supported PMA local loop-back mode is not supported by GPY

PMA/PMD status 1 (Register 1.1)

IEEE Standard Register=1.1

PMA_STAT1

PMA/PMD status 1 (Register 1.1)

Reset Value

0000_H

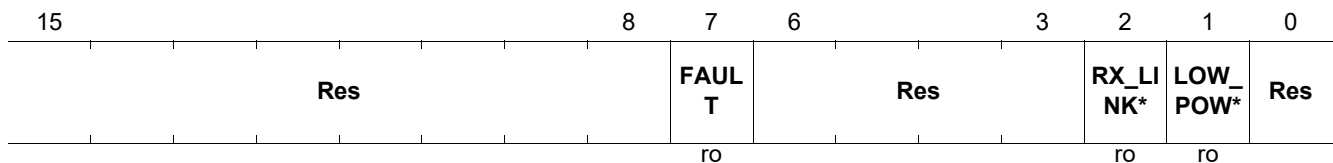

Field	Bits	Type	Description
FAULT	7	RO	Fault 1 = Fault condition detected 0 = Fault condition not detected
RX_LINK_STATUS	2	RO	Receive Link Status 1 = PMA/PMD receive link up 0 = PMA/PMD receive link down
LOW_POWER_ABILITY	1	RO	Low Power Ability 1 = PMA/PMD supports low power mode 0 = PMA/PMD does not support low power mode

PHY Identifier 1 (Register 1.2)

IEEE Standard Register=1.2

Bits 31 - 16 of Device ID

PMA_DEVID1

PHY Identifier 1 (Register 1.2)

Reset Value

67C9_H

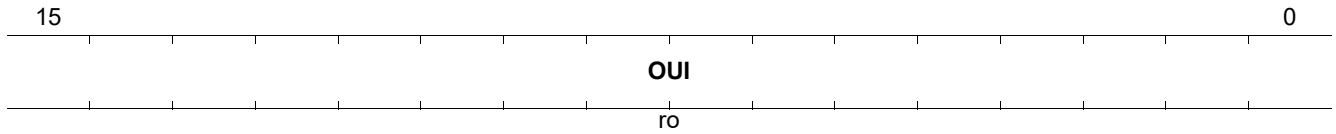

Field	Bits	Type	Description
OUI	15:0	RO	Organizationally Unique Identifier Organizationally Unique Identifier Bits 3:18

PHY Identifier 2 (Register 1.3)

IEEE Standard Register=1.3

Bits 15 - 0 of Device ID

PMA_DEVID2

Reset Value

PHY Identifier 2 (Register 1.3)

DC00_H

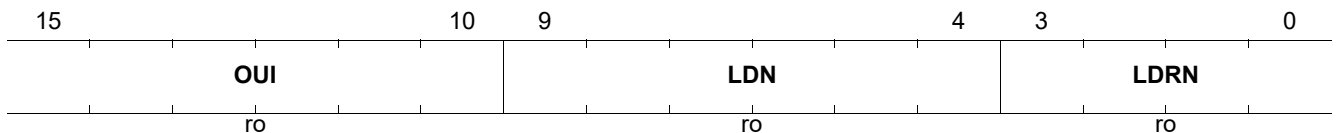

Field	Bits	Type	Description
OUI	15:10	RO	Organizationally Unique Identifier Bits 19:24
LDN	9:4	RO	Device Number Specifies the device number ¹⁾ to distinguish between several products.
LDRN	3:0	RO	Device Number Specifies the device revision number ¹⁾ to distinguish between several versions of this device

1) For the device specific reset value, refer to Product Naming table in the [Package Outline](#) chapter.

PMA/PMD speed ability (Register 1.4)

IEEE Standard Register=1.4

PMA_SPEED_ABILITY

Reset Value

PMA/PMD speed ability (Register 1.4)

0070_H

	15	14	13	12	11	10	9	8	7	6	5	4	3	2	1	0
	Res	CAP_5G	CAP_2G5	RES2	Res	CAP_100G	CAP_40G	CAP_10_1G*	CAP_10M	CAP_100M	CAP_1000M	Res	R10PASS*	CAP_2BA*	CAP_10G*	
		ro	ro	ro		ro	ro	ro	ro	ro	ro		ro	ro	ro	

Field	Bits	Type	Description
CAP_5G	14	RO	Not Supported 1 = PMA/PMD is capable of operating at 5 Gb/s 0 = PMA/PMD is not capable of operating as 5 Gb/s
CAP_2G5	13	RO	2.5 G capable 1 = PMA/PMD is capable of operating at 2.5 Gb/s 0 = PMA/PMD is not capable of operating as 2.5 Gb/s
RES2	12	RO	Reserved Value always 0
CAP_100G	9	RO	Not Supported 1 = PMA/PMD is capable of operating at 100 Gb/s 0 = PMA/PMD is not capable of operating as 100 Gb/s
CAP_40G	8	RO	Not Supported 1 = PMA/PMD is capable of operating at 40 Gb/s 0 = PMA/PMD is not capable of operating as 40 Gb/s
CAP_10_1G	7	RO	Not Supported 1 = PMA/PMD is capable of operating at 10 Gb/s downstream and 1 Gb/s upstream 0 = PMA/PMD is not capable of operating at 10 Gb/s downstream and 1 Gb/s upstream.
CAP_10M	6	RO	10M capable 1 = PMA/PMD is capable of operating at 10 Mb/s 0 = PMA/PMD is not capable of operating as 10 Mb/s
CAP_100M	5	RO	100M capable 1 = PMA/PMD is capable of operating at 100 Mb/s 0 = PMA/PMD is not capable of operating at 100 Mb/s
CAP_1000M	4	RO	1000M capable 1 = PMA/PMD is capable of operating at 1000 Mb/s 0 = PMA/PMD is not capable of operating at 1000 Mb/s
R10PASS_TS_CAPABLE	2	RO	Not Supported 1 = PMA/PMD is capable of operating as 10PASS-TS 0 = PMA/PMD is not capable of operating as 10PASS-TS

Field	Bits	Type	Description (cont'd)
CAP_2BASE_TL	1	RO	Not Supported 1 = PMA/PMD is capable of operating as 2BASE-TL 0 = PMA/PMD is not capable of operating as 2BASE-TL
CAP_10G_CAPP	0	RO	Not Supported 1 = PMA/PMD is capable of operating at 10 Gb/s 0 = PMA/PMD is not capable of operating at 10 Gb/s

Devices in package 1 (Register 1.5)

IEEE Standard Register=1.5

PMA_DIP1

Devices in package 1 (Register 1.5)

Reset Value

008B_H

15		12	11	10	9	8	7	6	5	4	3	2	1	0
RES		SEP_PMA*	SEP_PMA*	SEP_PMA*	SEP_PMA*	ANEG	TC	DTE_XS	PHY_XS	PCS	WIS	PMD_PMA	CLAU SE_*	
ro		ro	ro	ro	ro	ro	ro	ro	ro	ro	ro	ro	ro	

Field	Bits	Type	Description
RES	15:12	RO	Reserved Ignore on Read
SEP_PMA_4	11	RO	Separate PMA (4) 1 = Separated PMA (4) present in package 0 = Separated PMA (4) not present in package
SEP_PMA_3	10	RO	Separate PMA (3) 1 = Separated PMA (3) present in package 0 = Separated PMA (3) not present in package
SEP_PMA_2	9	RO	Separate PMA (2) 1 = Separated PMA (2) present in package 0 = Separated PMA (2) not present in package
SEP_PMA_1	8	RO	Separate PMA (1) 1 = Separated PMA (1) present in package 0 = Separated PMA (1) not present in package
ANEG	7	RO	Auto-Negotiation present This bit is always set to 1 in GPY 1 = Auto-Negotiation present in package 0 = Auto-Negotiation not present in package
TC	6	RO	TC present 1 = TC present in package 0 = TC not present in package
DTE_XS	5	RO	DTE XS present 1 = DTE XS present in package 0 = DTE XS not present in package

Field	Bits	Type	Description (cont'd)
PHY_XS	4	RO	PHY XS present 1 = PHY XS present in package 0 = PHY XS not present in package
PCS	3	RO	PCS present This bit is always set to 1 in GPY 1 = PCS present in package 0 = PCS not present in package
WIS	2	RO	WIS present 1 = WIS present in package 0 = WIS not present in package
PMD_PMA	1	RO	PMD/PMA present This bit is always set to 1 in GPY 1 = PMA/PMD present in package 0 = PMA/PMD not present in package
CLAUSE_22	0	RO	Clause 22 registers present This bit is always set to 1 in GPY 1 = Clause 22 registers present in package 0 = Clause 22 registers not present in package

Devices in package 2 (Register 1.6)

IEEE Standard Register=1.6

PMA_DIP2

Reset Value

Devices in package 2 (Register 1.6)

C000_H

15	14	13	12		0
VSPE C2	VSPE C1	CLA_2 2_*	RES		
ro	ro	ro	ro		

Field	Bits	Type	Description
VSPEC2	15	RO	Vendor-specific device 2 This bit is always set to 1 in GPY 1 = Vendor-specific device 2 present in package 0 = Vendor-specific device 2 not present in package
VSPEC1	14	RO	Vendor-specific device 1 This bit is always set to 1 in GPY 1 = Vendor-specific device 1 present in package 0 = Vendor-specific device 1 not present in package
CLA_22_EXT	13	RO	Clause 22 extension 1 = Clause 22 extension present in package 0 = Clause 22 extension not present in package
RES	12:0	RO	Reserved Ignore on read

PMA/PMD control 2 (Register 1.7)

IEEE Standard Register=1.7

PMA_CTL2

PMA/PMD control 2 (Register 1.7)

Reset Value

0030_H

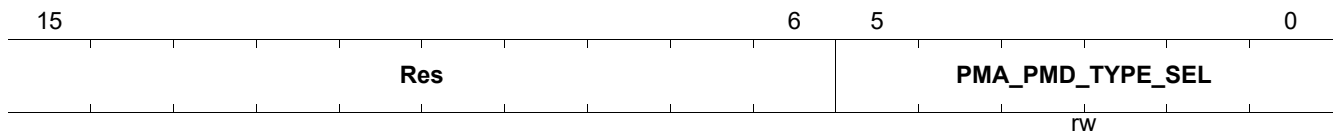

Field	Bits	Type	Description
PMA_PMD_TY PE_SEL	5:0	RW	PMA/PMD type selection 5 4 3 2 1 0 0 0 1 1 1 1 = 10BASE-T PMA/PMD 0 0 1 1 1 0 = 100BASE-TX PMA/PMD 0 0 1 1 0 0 = 1000BASE-T PMA/PMD Others = Reserved

PMA/PMD status 2 (Register 1.8)

IEEE Standard Register=1.8

PMA_STAT2

PMA/PMD status 2 (Register 1.8)

Reset Value

8200_H

	15	14	13	12	11	10	9	8	7	6	5	4	3	2	1	0	
	DEVICE_PRE SENT	TX_FAULT*	RX_FAULT*	TX_FAULT	RX_FAULT	EXT_ABILITIE S	PMD_TX_DIS ABLE	RMGBT_SR_A BILITY	RMGBT_LR_A BILITY	RMGBT_T_S*	RMGBT_T_L*	RMGBT_T_E*	RMGBT_T_L*	RMGBT_T_S*	RMGBT_T_L*	RMGBT_T_E*	PMA_LOC*
	ro	ro	ro	ro	ro	ro	ro	ro	ro	ro	ro	ro	ro	ro	ro	ro	ro

Field	Bits	Type	Description
DEVICE_PRE SENT	15:14	RO	Device present 1 0 = Device responding at this address 1 1 = No device responding at this address 0 1 = No device responding at this address 0 0 = No device responding at this address
TX_FAULT_A BILITY	13	RO	Transmit fault ability 1 = PMA/PMD has the ability to detect a fault condition on the transmit path 0 = PMA/PMD does not have the ability to detect a fault condition on the transmit path
RX_FAULT_A BILITY	12	RO	Receive fault ability 1 = PMA/PMD has the ability to detect a fault condition on the receive path 0 = PMA/PMD does not have the ability to detect a fault condition on the receive path
TX_FAULT	11	RO	Transmit fault 1 = Fault condition on transmit path 0 = No fault condition on transmit path
RX_FAULT	10	RO	Receive fault 1 = Fault condition on receive path 0 = No fault condition on receive path
EXT_ABILITIE S	9	RO	Extended abilities 1 = PMA/PMD has extended abilities listed in register 1.11 0 = PMA/PMD does not have extended abilities
PMD_TX_DIS ABLE	8	RO	PMD transmit disable 1 = PMD has the ability to disable the transmit path 0 = PMD does not have the ability to disable the transmit path
RMGBT_SR_A BILITY	7	RO	MULTIGBASE-SR ability 1 = PMA/PMD is able to perform MULTIGBASE-SR 0 = PMA/PMD is not able to perform MULTIGBASE-SR
RMGBT_LR_A BILITY	6	RO	MULTIGBASE-LR ability 1 = PMA/PMD is able to perform MULTIGBASE-LR 0 = PMA/PMD is not able to perform MULTIGBASE-LR

Field	Bits	Type	Description (cont'd)
RMGBT_ER_ABILITY	5	RO	MULTIGBASE-ER ability 1 = PMA/PMD is able to perform MULTIGBASE-ER 0 = PMA/PMD is not able to perform MULTIGBASE-ER
RMGBT_LX4_ABILITY	4	RO	MULTIGBASE-LX4 ability 1 = PMA/PMD is able to perform MULTIGBASE-LX4 0 = PMA/PMD is not able to perform MULTIGBASE-LX4
RMGBT_SW_ABILITY	3	RO	MULTIGBASE-SW ability 1 = PMA/PMD is able to perform MULTIGBASE-SW 0 = PMA/PMD is not able to perform MULTIGBASE-SW
RMGBT_LW_ABILITY	2	RO	MULTIGBASE-LW ability 1 = PMA/PMD is able to perform MULTIGBASE-LW 0 = PMA/PMD is not able to perform MULTIGBASE-LW
RMGBT_EW_ABILITY	1	RO	MULTIGBASE-EW ability 1 = PMA/PMD is able to perform MULTIGBASE-EW 0 = PMA/PMD is not able to perform MULTIGBASE-EW
PMA_LOCAL_LOOPBACK	0	RO	PMA Local Loop-back 1 = PMA has the ability to perform a local loop-back function 0 = PMA does not have the ability to perform a local loop-back function

PMA/PMD Extended Ability (Register 1.11)

IEEE Standard Register=1.11

PMA_EXT_ABILITY

Reset Value

PMA/PMD Extended Ability (Register 1.11)

01A0_H

15		14		13		11		10		9		8		7		6		5		4		3		2		1		0	
Res	R2G5_EX*			Res			R40G_10*	P2MP_AB*	R10B_ASE*	R100B_AS*	R1000_BA*	R1000_BA*	RMGBT_K*	RMGBT_K*	RMGBT_A*	RMGBT_L*	RMGBT_C*												
	ro						ro	ro	ro	ro	ro	ro	ro	ro	ro	ro	ro	ror	ror										

Field	Bits	Type	Description
R2G5_EXT_ABILITIES	14	RO	2.5G/5G extended abilities 1 = PMA/PMD has 2.5G/5G extended abilities listed in register 1.21 0 = PMA/PMD does not have 2.5G/5G extended abilities
R40G_100G_EXT_ABILITIES	10	RO	40G/100G extended abilities 1 = PMA/PMD has 40G/100G extended abilities listed in register 1.13 0 = PMA/PMD does not have 40G/100G extended abilities
P2MP_ABILITY	9	RO	P2MP ability 1 = PMA/PMD has P2MP abilities listed in register 1.12 0 = PMA/PMD does not have P2MP abilities
R10BASE_T_ABILITY	8	RO	10BASE-T ability 1 = PMA/PMD is able to perform 10BASE-T 0 = PMA/PMD is not able to perform 10BASE-T

Field	Bits	Type	Description (cont'd)
R100BASE_TX_ABILITY	7	RO	100BASE-TX ability 1 = PMA/PMD is able to perform 100BASE-TX 0 = PMA/PMD is not able to perform 100BASE-TX
R1000BASE_KX_ABILITY	6	RO	1000BASE-KX ability 1 = PMA/PMD is able to perform 1000BASE-KX 0 = PMA/PMD is not able to perform 1000BASE-KX
R1000BASE_T_ABILITY	5	RO	1000BASE-T ability 1 = PMA/PMD is able to perform 1000BASE-T 0 = PMA/PMD is not able to perform 1000BASE-T
RMGBT_KR_ABILITY	4	RO	MULTIGBASE-KR ability 1 = PMA/PMD is able to perform MULTIGBASE-KR 0 = PMA/PMD is not able to perform MULTIGBASE-KR
RMGBT_KX4_ABILITY	3	RO	MULTIGBASE-KX4 ability 1 = PMA/PMD is able to perform MULTIGBASE-KX4 0 = PMA/PMD is not able to perform MULTIGBASE-KX4
RMGBT_ABILITY	2	RO	10GBASE-T ability 1 = PMA/PMD is able to perform MULTIGBASE-T 0 = PMA/PMD is not able to perform MULTIGBASE-T
RMGBT_LRM_ABILITY	1	ROR	MULTIGBASE-LRM ability 1 = PMA/PMD is able to perform MULTIGBASE-LRM 0 = PMA/PMD is not able to perform MULTIGBASE-LRM
RMGBT_CX4_ABILITY	0	ROR	MULTIGBASE-CX4 ability 1 = PMA/PMD is able to perform MULTIGBASE-CX4 0 = PMA/PMD is not able to perform MULTIGBASE-CX4

AN package identifier (Register 1.14)

IEEE Standard Register=1.14

PMA_PACKID1

Reset Value

AN package identifier (Register 1.14)

67C9_H

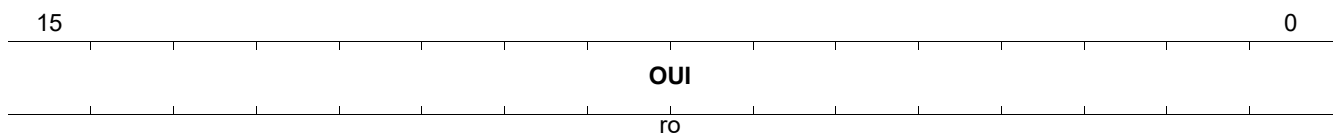

Field	Bits	Type	Description
OUI	15:0	RO	Organizationally Unique Identifier Organizationally Unique Identifier Bits 3:18

AN package identifier (Register 1.15)

IEEE Standard Register=1.15

PMA_PACKID2

AN package identifier (Register 1.15)

Reset Value

DC00_H

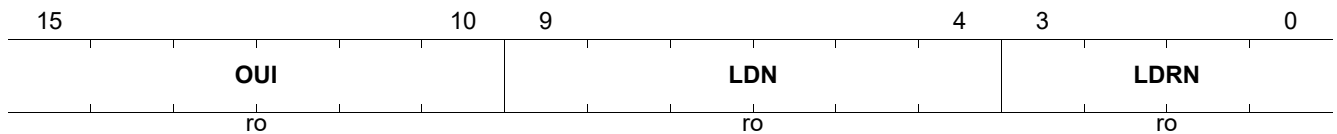

Field	Bits	Type	Description
OUI	15:10	RO	Organizationally Unique Identifier Bits 19:24
LDN	9:4	RO	Device Number Specifies the device number ¹⁾ to distinguish between several products.
LDRN	3:0	RO	Device Number Specifies the device revision number ¹⁾ to distinguish between several versions of this device

1) For the device specific reset value, refer to Product Naming table in the [Package Outline](#) chapter.

PMAPMD Extended Ability (Register 1.21)

Read only, write from STA has no effect

IEEE Standard Register=1.21

PMA_MGBT_EXTAB

PMAPMD Extended Ability (Register 1.21)

Reset Value

0000_H



Field	Bits	Type	Description
RES	15:2	RO	Reserved Value always 0
AB5G	1	RO	PMA Ability to perform 5GBT 0 _B UNABLE PMA is not able to perform 5GBT 1 _B ABLE PMA Able to perform 5GBT
AB2G5	0	RO	PMA Ability to perform 2G5BT 0 _B UNABLE PMA is not able to perform 2G5BT 1 _B ABLE PMA Able to perform 2G5BT

MULTIGBASE-T pair swap and polarity (Register 1.130)

IEEE Standard Register=1.130

PMA_MGBT_POLARITY

Reset Value

MULTIGBASE-T pair swap and polarity (Register 1.130)

0003_H

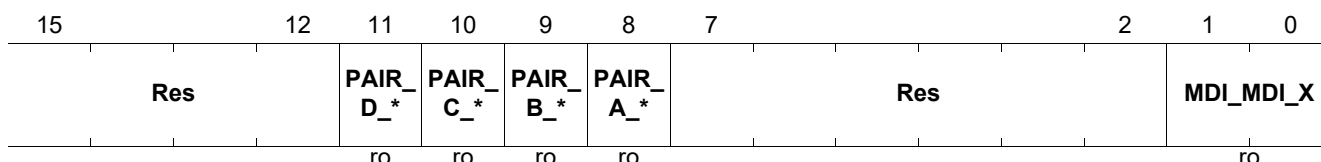

Field	Bits	Type	Description
PAIR_D_POLARITY	11	RO	Pair D polarity 1 = Polarity of pair D is reversed 0 = Polarity of pair D is not reversed
PAIR_C_POLARITY	10	RO	Pair C polarity 1 = Polarity of pair C is reversed 0 = Polarity of pair C is not reversed
PAIR_B_POLARITY	9	RO	Pair B polarity 1 = Polarity of pair B is reversed 0 = Polarity of pair B is not reversed
PAIR_A_POLARITY	8	RO	Pair A polarity 1 = Polarity of pair A is reversed 0 = Polarity of pair A is not reversed
MDI_MDI_X	1:0	RO	MDI/MDI-X Indicates the status of pair swaps at the MDI / MD-X 00 _B ABCD CROSS Pair AB and Pair CD crossover 01 _B CD CROSS Pair CD crossover only 10 _B AB CROSS Pair AB crossover only 11 _B NORMAL No crossover

MULTIGBASE-T TX power backoff and PHY short reach setting (Register 1.131)

IEEE Standard Register=1.131

PMA_MGBT_TX_PBO

Reset Value

MULTIGBASE-T TX power backoff and PHY short reach setting (Register 1.131)

0000_H

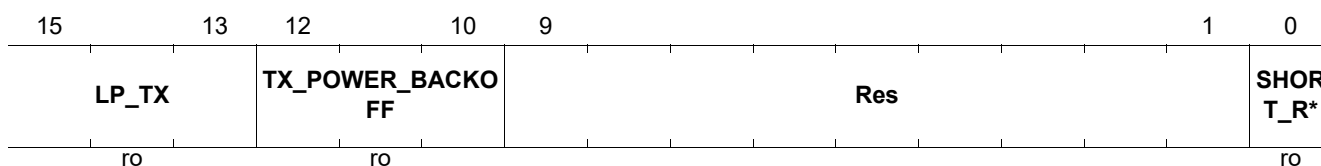

Field	Bits	Type	Description
LP_TX	15:13	RO	Link partner TX The power backoff setting of the link partner Bit number assignment: 15 14 13 ----- 1 1 1 = 14 dB 1 1 0 = 12 dB 1 0 1 = 10 dB 1 0 0 = 8 dB 0 1 1 = 6 dB 0 1 0 = 4 dB 0 0 1 = 2 dB 0 0 0 = 0 dB
TX_POWER_BACKOFF	12:10	RO	TX power backoff The power backoff of PHY211 PMA Bit number assignment: 12 11 10 ----- 1 1 1 = 14 dB 1 1 0 = 12 dB 1 0 1 = 10 dB 1 0 0 = 8 dB 0 1 1 = 6 dB 0 1 0 = 4 dB 0 0 1 = 2 dB 0 0 0 = 0 dB
SHORT_REACH_MODE	0	RO	Short reach mode 1 = PHY is operating in short reach mode (not supported) 0 = PHY is not operating in short reach mode

MULTIGBASE-T test mode (Register 1.132)

IEEE Standard Register=1.132

PMA_MGBT_TEST_MODE

Reset Value

MULTIGBASE-T test mode (Register 1.132)

0000_H

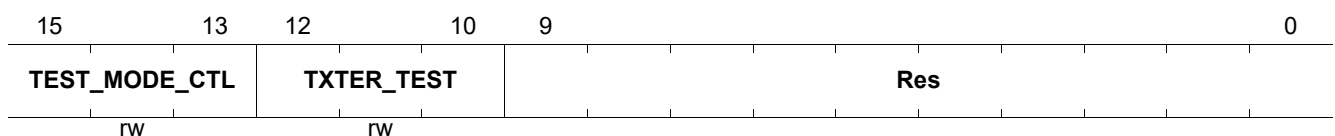

Field	Bits	Type	Description
TEST_MODE_CTL	15:13	RW	Test mode control 1 1 1 = Test mode 7 1 1 0 = Test mode 6 1 0 1 = Test mode 5 1 0 0 = Test mode 4 0 1 1 = Test mode 3 0 1 0 = Test mode 2 0 0 1 = Test mode 1 0 0 0 = Normal operation
TXTER_TEST	12:10	RW	Transmitter test Frequencies for tones used in Test Mode 4 1 1 1 = Reserved 1 1 0 = Dual tone 5 1 0 1 = Dual tone 4 1 0 0 = Dual tone 3 0 1 1 = Reserved 0 1 0 = Dual tone 2 0 0 1 = Dual tone 1 0 0 0 = Reserved

MULTIGBASE-T SNR Margin Channel A (Register 1.133)

Register 1.133 contains the current SNR operating margin measured at the slicer input for channel A for the MULTIGBASE-T PMA.

IEEE Standard Register=1.133

PMA_MGBT_SNR_OPMARGIN_A	Reset Value
MULTIGBASE-T SNR Margin Channel A (Register 1.133)	0000_H
15	0
OPMARGIN_A	
ro	

Field	Bits	Type	Description
OPMARGIN_A	15:0	RO	OPMARGIN_A SNR operating margin measured at the slicer input for channel A

MULTIGBASE-T SNR Margin Channel B (Register 1.134)

Register 1.134 contains the current SNR operating margin measured at the slicer input for channel B for the MULTIGBASE-T PMA.

IEEE Standard Register=1.134

PMA_MGBT_SNR_OPMARGIN_B	Reset Value
MULTIGBASE-T SNR Margin Channel B (Register 1.134)	0000_H

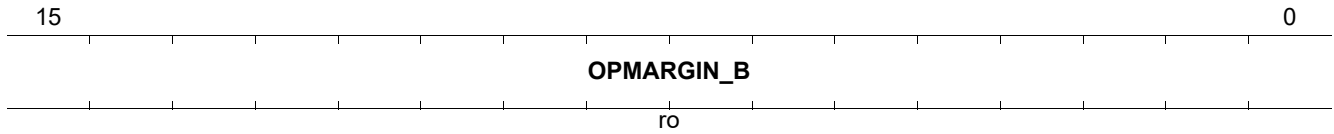

Field	Bits	Type	Description
OPMARGIN_B	15:0	RO	OPMARGIN_B SNR operating margin measured at the slicer input for channel B

MULTIGBASE-T SNR Margin Channel C (Register 1.135)

Register 1.135 contains the current SNR operating margin measured at the slicer input for channel C for the MULTIGBASE-T PMA.

IEEE Standard Register=1.135

PMA_MGBT_SNR_OPMARGIN_C

Reset Value

MULTIGBASE-T SNR Margin Channel C (Register 1.135)

0000_H

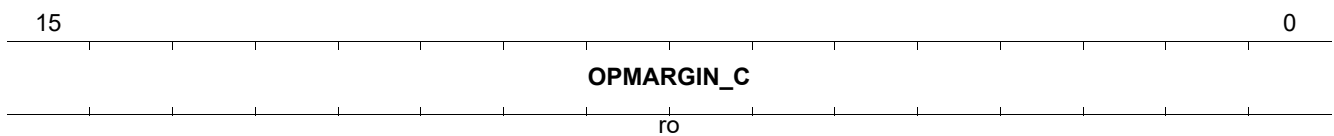

Field	Bits	Type	Description
OPMARGIN_C	15:0	RO	OPMARGIN_C SNR operating margin measured at the slicer input for channel C

MULTIGBASE-T SNR Margin Channel D (Register 1.136)

Register 1.136 contains the current SNR operating margin measured at the slicer input for channel D for the MULTIGBASE-T PMA.

IEEE Standard Register=1.136

PMA_MGBT_SNR_OPMARGIN_D

Reset Value

MULTIGBASE-T SNR Margin Channel D (Register 1.136)

0000_H

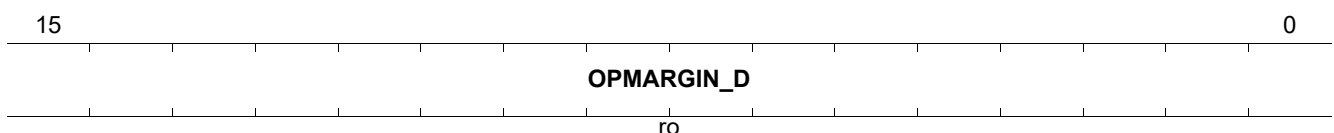

Field	Bits	Type	Description
OPMARGIN_D	15:0	RO	OPMARGIN_D SNR operating margin measured at the slicer input for channel D

MULTIGBASE-T SNR Min Margin Channel A (Register 1.137)

The minimum margin channel A register contains a latched copy of the lowest value observed in the SNR operating margin channel A register (1.133) since the last read.

IEEE Standard Register=1.137

PMA_MGBT_MINMARGIN_A **Reset Value**
MULTIGBASE-T SNR Min Margin Channel A (Register **0000_H**
1.137)

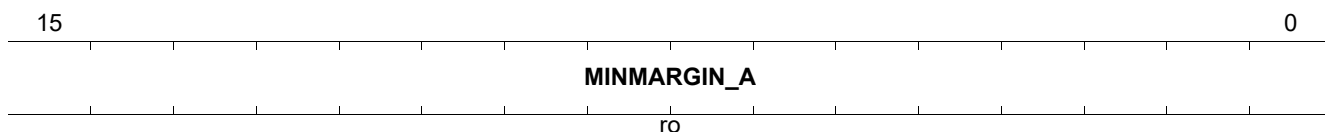

Field	Bits	Type	Description
MINMARGIN_A	15:0	RO	MINMARGIN_A Lowest value observed in the SNR operating margin channel A register (1.133) since the last read

MULTIGBASE-T SNR Min Margin Channel B (Register 1.138)

The minimum margin channel A register contains a latched copy of the lowest value observed in the SNR operating margin channel B register (1.134) since the last read.

IEEE Standard Register=1.138

PMA_MGBT_MINMARGIN_B **Reset Value**
MULTIGBASE-T SNR Min Margin Channel B (Register **0000_H**
1.138)

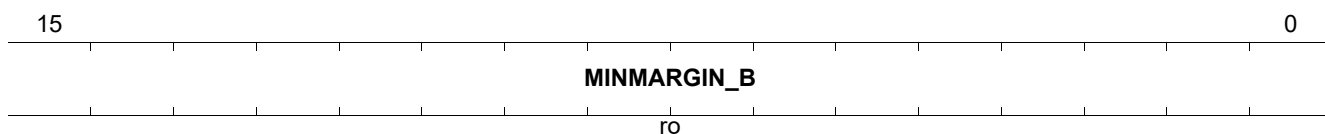

Field	Bits	Type	Description
MINMARGIN_B	15:0	RO	MINMARGIN_B Lowest value observed in the SNR operating margin channel B register (1.134) since the last read

MULTIGBASE-T SNR Min Margin Chan C (Register 1.139)

The minimum margin channel C register contains a latched copy of the lowest value observed in the SNR operating margin channel C register (1.135) since the last read.

IEEE Standard Register=1.139

PMA_MGBT_MINMARGIN_C **Reset Value**
MULTIGBASE-T SNR Min Margin Chan C (Register 1.139) **0000_H**

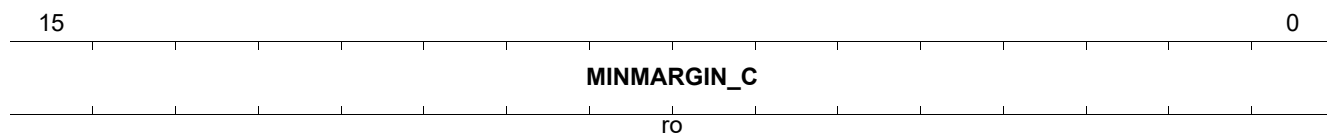

Field	Bits	Type	Description
MINMARGIN_C	15:0	RO	MINMARGIN_C Lowest value observed in the SNR operating margin channel C register (1.135) since the last read

MULTIGBASE-T SNR Min Margin Chan D (Register 1.140)

The Minimum margin channel D register contains a latched copy of the lowest value observed in the SNR operating margin channel D register (1.136) since the last read.

IEEE Standard Register=1.140

PMA_MGBT_MINMARGIN_D **Reset Value**
MULTIGBASE-T SNR Min Margin Chan D (Register 1.140) **0000_H**

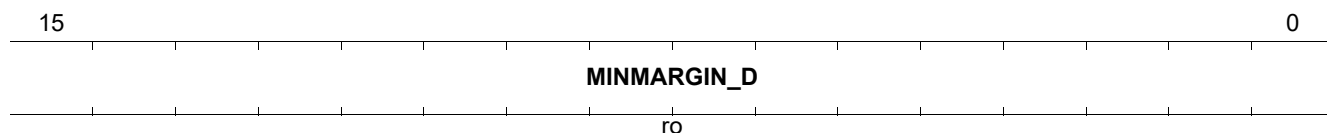

Field	Bits	Type	Description
MINMARGIN_D	15:0	RO	MINMARGIN_D Lowest value observed in the SNR operating margin channel D register (1.136) since the last read

MULTIGBASE-T Rx Power Channel A (Register 1.141)

The RX signal power channel A register is read only and contains the receive signal power measured at the MDI during training as described in 55.4.3.1.

IEEE Standard Register=1.141

PMA_MGBT_POWER_A **Reset Value**
MULTIGBASE-T Rx Power Channel A (Register 1.141) **0000_H**

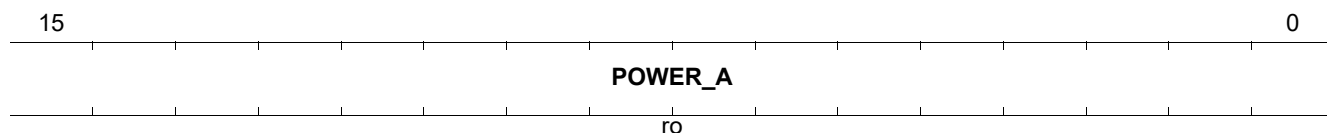

Field	Bits	Type	Description
POWER_A	15:0	RO	POWER_A Receive signal power measured at the MDI during training

MULTIGBASE-T Rx Power Channel B (Register 1.142)

The RX signal power channel B register is read only and contains the receive signal power measured at the MDI during training as described in 55.4.3.1.

IEEE Standard Register=1.142

PMA_MGBT_POWER_B **Reset Value**
MULTIGBASE-T Rx Power Channel B (Register 1.142) **0000_H**

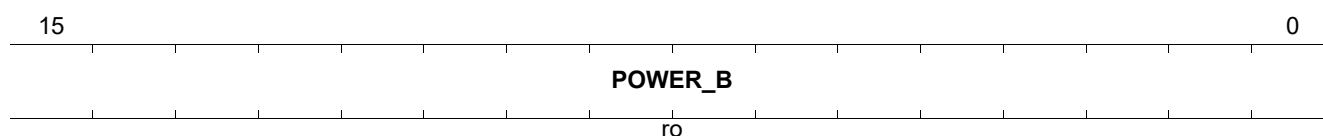

Field	Bits	Type	Description
POWER_B	15:0	RO	POWER_B Receive signal power measured at the MDI during training

MULTIGBASE-T Rx Power Chan C (Register 1.143)

The RX signal power channel C register is read only and contains the receive signal power measured at the MDI during training as described in 55.4.3.1.

IEEE Standard Register=1.143

PMA_MGBT_POWER_C **Reset Value**
MULTIGBASE-T Rx Power Chan C (Register 1.143) **0000_H**

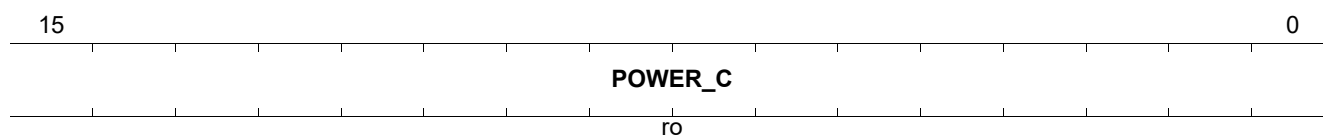

Field	Bits	Type	Description
POWER_C	15:0	RO	POWER_C Receive signal power measured at the MDI during training

MULTIGBASE-T Rx Power Chan D (Register 1.144)

The RX signal power channel D register is read only and contains the receive signal power measured at the MDI during training as described in 55.4.3.1.

IEEE Standard Register=1.144

PMA_MGBT_POWER_D **Reset Value**
MULTIGBASE-T Rx Power Chan D (Register 1.144) **0000_H**

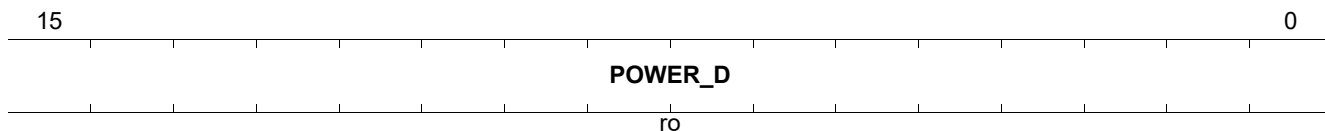

Field	Bits	Type	Description
POWER_D	15:0	RO	POWER_D Receive signal power measured at the MDI during training

MULTIGBASE-T skew delay 0 (Register 1.145)

IEEE Standard Register=1.145

The skew delay reports the current skew delay on each of the pairs with respect to physical pair A. It is reported with 1.25 ns resolution to an accuracy of 2.5 ns. The number is in two's complement notation with positive values representing delay and negative values representing advance with respect to physical pair A. If the delay exceeds the maximum amount that can be represented by the range (-80 ns to +78.75 ns), the field displays the maximum value.

PMA_MGBT_SKEW_DELAY_0 **Reset Value**
MULTIGBASE-T skew delay 0 (Register 1.145) **0000_H**

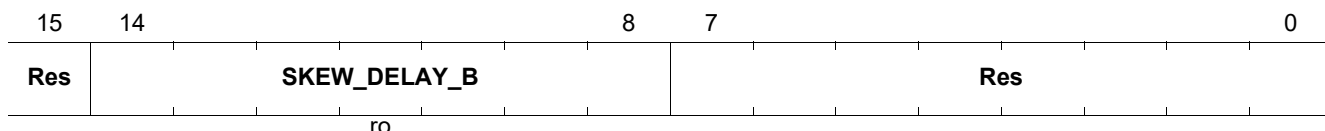

Field	Bits	Type	Description
SKEW_DELAY_B	14:8	RO	Skew delay B Skew delay for pair B

MULTIGBASE-T skew delay 1 (Register 1.146)

IEEE Standard Register=1.146

The skew delay reports the current skew delay on each of the pairs with respect to physical pair A. It is reported with 1.25 ns resolution to an accuracy of 2.5 ns. The number is in two's complement notation with positive values representing delay and negative values representing advance with respect to physical pair A. If the delay exceeds the maximum amount that can be represented by the range (-80 ns to +78.75 ns), the field displays the maximum value.

PMA_MGBT_SKEW_DELAY_1 **Reset Value**
MULTIGBASE-T skew delay 1 (Register 1.146) **0000_H**

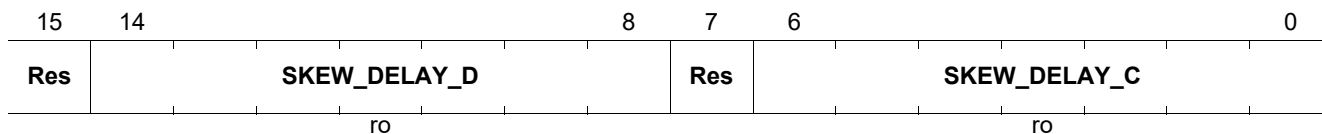

Field	Bits	Type	Description
SKEW_DELAY_D	14:8	RO	Skew delay D Skew delay for pair D
SKEW_DELAY_C	6:0	RO	Skew delay C Skew delay for pair C

MULTIGBASE-T skew delay 2 (Register 1.147)

IEEE Standard Register=1.147

**PMA_MGBT_FAST_RETRAIN_STA_CTRL
MULTIGBASE-T skew delay 2 (Register 1.147)**

Reset Value

0000_H

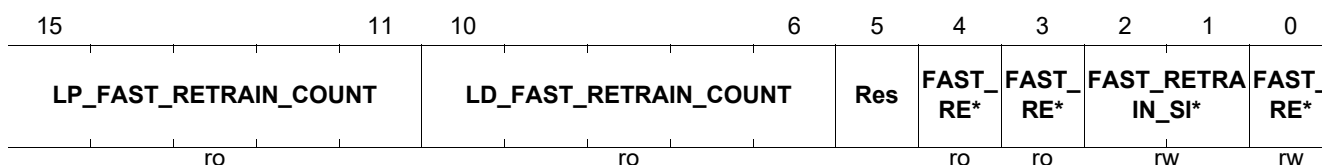

Field	Bits	Type	Description
LP_FAST_RETRAIN_COUNT	15:11	RO	LP fast retrain count Counts the number of fast retrains requested by the link partner
LD_FAST_RETRAIN_COUNT	10:6	RO	LD fast retrain count Counts the number of fast retrains requested by the local device
FAST_RETRAIN_ABILITY	4	RO	Fast retrain ability 1 = Fast retrain capability is supported 0 = Fast retrain capability is not supported
FAST_RETRAIN_NEGOTIATED	3	RO	Fast retrain negotiated 1 = Fast retrain capability was negotiated 0 = Fast retrain capability was not negotiated
FAST_RETRAIN_SIG_TYPE	2:1	RW	Fast retrain signal type 11 = Reserved 10 = PHY signals Link Interruption during fast retrain 01 = PHY signals Local Fault during fast retrain 00 = PHY signals IDLE during fast retrain
FAST_RETRAIN_ENABLE	0	RW	Fast retrain enable 1 = Fast retrain capability is enabled 0 = Fast retrain capability is disabled

PMA TimeSync Capability Indication (Register 1.1800)

PMA TimeSync Capability indication Register.

GPY does not support providing data path delay information.
IEEE Standard Register=1.1800

PMA_TIMESYNC_CAP **Reset Value**
PMA TimeSync Capability Indication (Register 1.1800) **0000_H**

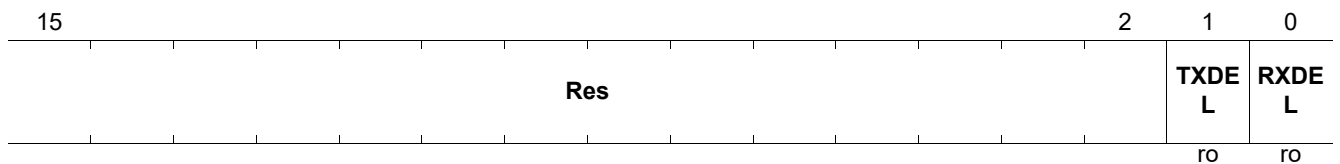

Field	Bits	Type	Description
TXDEL	1	RO	Transmit Data Path Delay Information Not supported by GPY 0 _B NONE PHYs do not have this capability 1 _B CAPABLE min and max TX data path delay available
RXDEL	0	RO	Receive Data Path Delay Information Not supported by GPY 0 _B NONE PHYs do not have this capability 1 _B CAPABLE min and max RX data path delay available

6.2 Standard PCS Registers for MMD=0x03

This section describes the PCS registers for MMD device 0x03.

Table 22 Registers Overview

Register Short Name	Register Long Name	Reset Value
PCS_CTRL1	PCS control 1 (Register 3.0)	005C _H
PCS_STAT1	PCS status 1 (Register 3.1)	0000 _H
PCS_DEVID1	PHY Identifier 1 (Register 3.2)	67C9 _H
PCS_DEVID2	PHY Identifier 2 (Register 3.3)	DC00 _H ¹⁾
PCS_SPEED_ABILITY	PCS speed ability (Register 3.4)	0000 _H
PCS_DIP1	PCS Devices in package 1 (Register 3.5)	008B _H
PCS_DIP2	PCS Devices in package 2 (Register 3.6)	C000 _H
PCS_STAT2	PCS status 2 (Register 3.8)	8000 _H
PCS_PACKID1	PCS package identifier 1 (Register 3.14)	67C9 _H
PCS_PACKID2	PCS package identifier 2 (Register 3.15)	DC00 _H ¹⁾
PCS_EEE_CAP	PCS EEE capability (Register 3.20)	0006 _H
PCS_EEE_CAP2	EEE control and capability 2 (Register 3.21)	0000 _H
PCS_EEE_WAKERR	PCS EEE Status Register 1 (Register 3.22)	0000 _H
PCS_TIMESYNC_CAP	PCS TimeSync capability register (Register 3.1800)	0000 _H

1) For the device specific reset value, refer to Product Naming table in the [Package Outline](#) chapter.

6.2.1 Standard PCS Registers for MMD=0x03

This chapter describes all registers of PCS in detail.

PCS control 1 (Register 3.0)

IEEE Standard Register=3.0

PCS_CTRL1

Reset Value

PCS control 1 (Register 3.0)

005C_H

15	14	13	12	11	10	9	7	6	5	2	1	0
RST	LOOP BACK	SSL	Res	LOW POW*	RXCK ST	Res	SSM	SPEED_SEL	Res			
rw	rw	rw		rw	rw		rw		rw			

Field	Bits	Type	Description
RST	15	RW	Reset 1 = PCS reset - Self Clearing 0 = Normal operation

Field	Bits	Type	Description (cont'd)
LOOPBACK	14	RW	Loopback 1 = Enable loopback mode 0 = Disable loopback mode
SSL	13	RW	Forced Speed selection (LSB) This bit is used in conjunction with SPEED_SEL_LSB MSB LSB 1 1 = bits 5:2 select speed 1 0 = 1000 Mb/s 0 1 = 100 Mb/s 0 0 = 10 Mb/s
LOW_POWER	11	RW	Low power 1 = Low-power mode 0 = Normal operation
RXCKST	10	RW	Clock stop enable 1 = The GPY will stop the (X)GMII clock during LPI 0 = Clock not stoppable The MAC can set this bit to active to allow the GPY to stop the clocking during the LPI_MODE.
SSM	6	RW	Forced Speed selection (MSB) This bit is used in conjunction with SPEED_SEL_MSB MSB LSB 1 1 = bits 5:2 select speed 1 0 = 1000 Mb/s 0 1 = 100 Mb/s 0 0 = 10 Mb/s
SPEED_SEL	5:2	RW	Forced Speed selection Values Reserved 0111 _B S2G5 Forced Speed is 2G5

PCS status 1 (Register 3.1)

IEEE Standard Register=3.1

PCS_STAT1

PCS status 1 (Register 3.1)

Reset Value

0000_H

15	12	11	10	9	8	7	6	5	3	2	1	0
Res		TX_LP L*	RX_LP L*	TX_LP L*	RX_LP L*	FAUL T	TXCK ST	Res		PCS_ RX_*	LOW_ POW*	Res
		ro	ro	ro	ro	ro	ro			ro	ro	

Field	Bits	Type	Description
TX_LPI_RXD	11	RO	Tx LPI received 1 = Tx PCS has received LPI 0 = LPI not received
RX_LPI_RXD	10	RO	Rx LPI received 1 = Rx PCS has received LPI 0 = LPI not received
TX_LPI_INDICATION	9	RO	Tx LPI indication 1 = Tx PCS is currently receiving LPI 0 = PCS is not currently receiving LPI
RX_LPI_INDICATION	8	RO	Rx LPI indication 1 = Rx PCS is currently receiving LPI 0 = PCS is not currently receiving LPI
FAULT	7	RO	Fault 1 = Fault condition detected 0 = No fault condition detected
TXCKST	6	RO	Clock stop capable 1 = The MAC may stop the clock during LPI 0 = Clock not stoppable
PCS_RX_LINK_STATUS	2	RO	PCS receive link status 1 = PCS receive link up 0 = PCS receive link down
LOW_POWER_ABILITY	1	RO	Low-power ability 1 = PCS supports low-power mode 0 = PCS does not support low-power mode

PHY Identifier 1 (Register 3.2)

IEEE Standard Register=3.2

PCS_DEVID1

Reset Value

PHY Identifier 1 (Register 3.2)

67C9_H

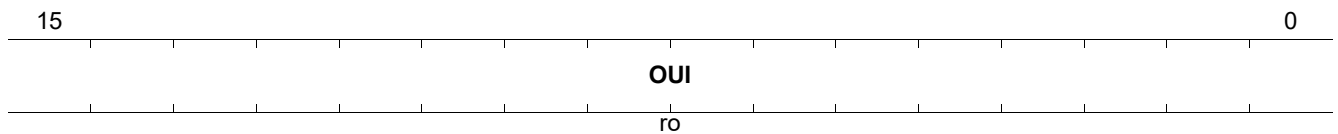

Field	Bits	Type	Description
OUI	15:0	RO	Organizationally Unique Identifier Bits 3:18

PHY Identifier 2 (Register 3.3)

Organizationally Unique Identifier Bits 19:24

IEEE Standard Register=3.3

PCS_DEVID2

Reset Value

PHY Identifier 2 (Register 3.3)

DC00_H



Field	Bits	Type	Description
OUI	15:10	RO	Organizationally Unique Identifier Bits 19:24
LDN	9:4	RO	Device Number Specifies the device number ¹⁾ to distinguish between several products.
LDRN	3:0	RO	Device Number Specifies the device revision number ¹⁾ to distinguish between several versions of this device

1) For the device specific reset value, refer to Product Naming table in the [Package Outline](#) chapter.

PCS speed ability (Register 3.4)

IEEE Standard Register=3.4

PCS_SPEED_ABILITY

PCS speed ability (Register 3.4)

Reset Value

0000_H

15						7	6	5	4	3	2	1	0
							R2G5_CA*		Res	R100G_C*	R40G_CA*	R10PASS*	R10G_CA*
							ro			ro	ro	ro	ro

Field	Bits	Type	Description
R2G5_CAPABLE	6	RO	2G5 capable Bit is always set to 0 because PCS is not capable of operating at 2.5 Gb/s
R100G_CAPABLE	3	RO	100G capable 1 = PCS is capable of operating at 100 Gb/s 0 = PCS is not capable of operating at 100 Gb/s
R40G_CAPABLE	2	RO	40G capable 1 = PCS is capable of operating at 40 Gb/s 0 = PCS is not capable of operating at 40 Gb/s
R10PASS_TS_2BASE_TL	1	RO	10PASS-TS/2BASE-TL Capable 1 = PCS is capable of operating as the 10P/2B PCS 0 = PCS is not capable of operating as the 10P/2B PCS
R10G_CAPABLE	0	RO	10G capable 1 = PCS is capable of operating at 10 Gb/s 0 = PCS is not capable of operating at 10 Gb/s

PCS Devices in package 1 (Register 3.5)

IEEE Standard Register=3.5

PCS_DIP1

PCS Devices in package 1 (Register 3.5)

Reset Value

008B_H

15														
	RES		SEPARAT*	SEP_PMA*	SEPARAT*	SEPARAT*	ANEG	TC	DTE_XS	PHY_XS	PCS	WIS_PRE*	PMD_PMA	CL22
	ro		ro	ro	ro	ro	ro	ro	ro	ro	ro	ro	ro	ro

Field	Bits	Type	Description
RES	15:12	RO	Reserved Ignore on Read
SEPARATED_PMA_4	11	RO	Separate PMA (4) 1 = Separate PMA (4) present in package



Field	Bits	Type	Description (cont'd)
SEP_PMA_3	10	RO	Separate PMA (3) 1 = Separate PMA (3) present in package 0 = Separate PMA (3) not present in package
SEPARATED_PMA_2	9	RO	Separate PMA (2) 1 = Separate PMA (2) present in package present 0 = Separate PMA (2) not present in package
SEPARATED_PMA_1	8	RO	Separate PMA (1) 1 = Separate PMA (1) present in package present 0 = Separate PMA (1) not present in package
ANEG	7	RO	Auto-Negotiation present 1 = Auto-Negotiation present in package 0 = Auto-Negotiation not present in package
TC	6	RO	TC present 1 = TC present in package 0 = TC not present in package
DTE_XS	5	RO	DTE XS present 1 = DTE XS present in package 0 = DTE XS not present in package
PHY_XS	4	RO	PHY XS present 1 = PHY XS present in package 0 = PHY XS not present in package
PCS	3	RO	PCS present 1 = PCS present in package 0 = PCS not present in package
WIS_PRESENT	2	RO	WIS present 1 = WIS present in package 0 = WIS not present in package
PMD_PMA	1	RO	PMD/PMA present 1 = PMA/PMD present in package 0 = PMA/PMD not present in package
CL22	0	RO	Clause 22 registers present 1 = Clause 22 registers present in package 0 = Clause 22 registers not present in package

PCS Devices in package 2 (Register 3.6)

IEEE Standard Register=3.6

PCS_DIP2

Reset Value

PCS Devices in package 2 (Register 3.6)

C000_H

15	14	13	12								0	
VEND OR_*	VEND OR_*	CLAU SE_*									RES	
ro	ro	ro									ro	

Field	Bits	Type	Description
VENDOR_SPECIFIC_DEVICE_2	15	RO	Vendor-specific device 2 1 = Vendor-specific device 2 present in package 0 = Vendor-specific device 2 not present in package
VENDOR_SPECIFIC_DEVICE_1	14	RO	Vendor-specific device 1 1 = Vendor-specific device 1 present in package 0 = Vendor-specific device 1 not present in package
CLAUSE_22_EXTENSION	13	RO	Clause 22 extension 1 = Clause 22 extension present in package 0 = Clause 22 extension not present in package
RES	12:0	RO	Reserved Ignore on read

PCS status 2 (Register 3.8)

IEEE Standard Register=3.8

PCS_STAT2

PCS status 2 (Register 3.8)

Reset Value

8000_H

	15	14	13	12	11	10	9	8	7	6	5	4	3	2	1	0
	DEVICE_PRE SENT	Res	R2G5_ CA*	TX_FA ULT	RX_F AULT	Res				R100G BA*	R40G BAS*	R10G BAS*	R10G BAS*	R10G BAS*	R10G BAS*	
	ro		ro	ro	ro					ro	ro	ro	ro	ro	ro	

Field	Bits	Type	Description
DEVICE_PRE SENT	15:14	RO	Device present 1 0 = Device responding at this address 1 1 = No device responding at this address 0 1 = No device responding at this address 0 0 = No device responding at this address
R2G5_CAPABLE	12	RO	2G5BASE-T capable 1 = PCS is able to support 2.5GBASE-T PCS Type 0 = Not able to support 2.5GBASE-T
TX_FAULT	11	RO	Transmit fault 1 = Fault condition on transmit path 0 = No fault condition on transmit path
RX_FAULT	10	RO	Receive fault 1 = Fault condition on the receive path 0 = No fault condition on the receive path
R10GBASE_R_CAPABLE	5	RO	100GBASE-R capable 1 = PCS is able to support 100GBASE-R PCS type 0 = PCS is not able to support 100GBASE-R PCS type
R40GBASE_R_CAPABLE	4	RO	40GBASE-R capable 1 = PCS is able to support 40GBASE-R PCS type 0 = PCS is not able to support 40GBASE-R PCS type
R10GBASE_T_CAPABLE	3	RO	10GBASE-T capable 1 = PCS is able to support 10GBASE-T PCS type 0 = PCS is not able to support 10GBASE-T PCS type
R10GBASE_W_CAPABLE	2	RO	10GBASE-W capable 1 = PCS is able to support 10GBASE-W PCS type 0 = PCS is not able to support 10GBASE-W PCS type
R10GBASE_X_CAPABLE	1	RO	10GBASE-X capable 1 = PCS is able to support 10GBASE-X PCS type 0 = PCS is not able to support 10GBASE-X PCS type
R10GBASE_R_CAPABLE	0	RO	10GBASE-R capable 1 = PCS is able to support 10GBASE-R PCS types 0 = PCS is not able to support 10GBASE-R PCS types

PCS package identifier 1 (Register 3.14)

IEEE Standard Register=3.14

PCS_PACKID1

Reset Value

PCS package identifier 1 (Register 3.14)

67C9_H

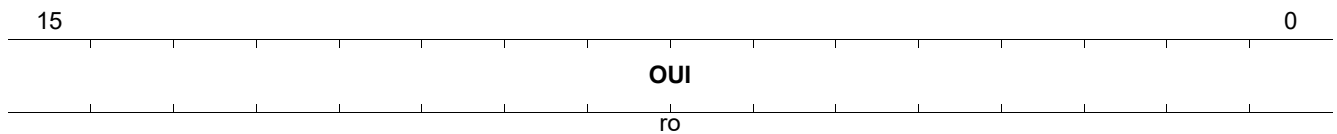

Field	Bits	Type	Description
OUI	15:0	RO	Organizationally Unique Identifier Bits 3:18

PCS package identifier 2 (Register 3.15)

IEEE Standard Register=3.15

PCS_PACKID2

Reset Value

PCS package identifier 2 (Register 3.15)

DC00_H



Field	Bits	Type	Description
OUI	15:10	RO	Organizationally Unique Identifier Bits 19:24
LDN	9:4	RO	Device Number Specifies the device number ¹⁾ to distinguish between several products.
LDRN	3:0	RO	Device Number Specifies the device revision number ¹⁾ to distinguish between several versions of this device

1) For the device specific reset value, refer to Product Naming table in the [Package Outline](#) chapter.

Field	Bits	Type	Description
RES	15:2	RO	Reserved Value always 0
AB5GEEE	1	RO	EEE supported for 5GBT 0 _B UNABLE EEE supported for 5GBT 1 _B ABLE EEE supported for 5GBT
AB2G5EEE	0	RO	EEE supported for 2G5BT 0 _B UNABLE EEE not supported for 2G5BT 1 _B ABLE EEE supported for 2G5BT

PCS EEE Status Register 1 (Register 3.22)

IEEE Standard Register=3.22

PCS_EEE_WAKERR	Reset Value
PCS EEE Status Register 1 (Register 3.22)	0000 _H
15	0
ERRCNT	
RWSC	

Field	Bits	Type	Description
ERRCNT	15:0	RWSC	EEE Wake Error Counter This is a 16-bit saturating counter indicating the number of times the GPY PHY fails to wake up within the EEE time. This counter is cleared upon read from the STA.

PCS TimeSync capability register (Register 3.1800)

IEEE Standard Register=3.1800

PCS_TIMESYNC_CAP

PCS TimeSync capability register (Register 3.1800)

Reset Value

0000_H



Field	Bits	Type	Description
TIMESYNC_T X_PATH_DATA_DELAY	1	RO	TimeSync transmit path data delay 1 = PCS provides information on transmit path data delay in registers 3.1801 through 3.1804 0 = PCS does not provide information on transmit path data delay - for GPY, the value is always zero
TIMESYNC_R X_PATH_DATA_DELAY	0	RO	TimeSync receive path data delay 1 = PCS provides information on receive path data delay in registers 3.1805 through 3.1808 0 = PCS does not provide information on receive path data delay - for GPY, the value is always zero

6.3 Standard Auto-Negotiation Registers for MMD=0x07

This register file contains the auto-negotiation registers for MMD device 0x07.

Table 23 Registers Overview

Register Short Name	Register Long Name	Reset Value
ANEG_CTRL	Auto-Negotiation Control (Register 7.0)	3000 _H
ANEG_STAT	Auto-Negotiation Status (Register 7.1)	0008 _H
ANEG_DEVID1	PHY Identifier 1 (Register 7.2)	67C9 _H
ANEG_DEVID2	PHY Identifier 2 (Register 7.3)	DC00 _H ¹⁾
ANEG_DIP1	Device in Package 1 (Register 7.5)	008B _H
ANEG_DIP2	Device in Package 2 (Register 7.6)	C000 _H
ANEG_PACKID1	AN package identifier (Register 7.14)	67C9 _H
ANEG_PACKID2	AN package identifier (Register 7.15)	DC00 _H ¹⁾
ANEG_ADV	ANEG Adv. for GPY (Register 7.16)	01E1 _H
ANEG_LP_BP_AB	AN Link Partner Base Page Ability (Register 7.19)	01E0 _H
ANEG_XNP_TX1	ANEG Local Dev XNP TX1 (Register 7.22)	0000 _H
ANEG_XNP_TX2	ANEG Local Dev XNP TX2 (Register 7.23)	0000 _H
ANEG_XNP_TX3	ANEG Local Dev XNP TX3 (Register 7.24)	0000 _H
ANEG_LP_XNP_AB1	ANEG Link Partner XNP RX (Register 7.25)	0000 _H
ANEG_LP_XNP_AB2	ANEG Link Partner XNP RX (Register 7.26)	0000 _H
ANEG_LP_XNP_AB3	ANEG Link Partner XNP RX (Register 7.27)	0000 _H
ANEG_MGBT_AN_CTRL	MULTI GBT AN Control Register (Register 7.32)	0002 _H
ANEG_MGBT_AN_STA	MultiGBASE-T AN Status register (Register 7.33)	0000 _H
ANEG_EEE_AN_ADV1	EEE Advertisement 1 (Register 7.60)	0006 _H
ANEG_EEE_AN_LPAB1	EEE Link Partner Ability 1 (Register 7.61)	0000 _H
ANEG_EEE_AN_ADV2	EEE Advertisement 2 (Register 7.62)	0000 _H
ANEG_EEE_LP_AB2	EEE Link Partner Ability 2 (Register 7.63)	0001 _H

1) For the device specific reset value, refer to Product Naming table in the [Package Outline](#) chapter.

6.3.1 Standard Auto-Negotiation Registers for MMD=0x07

This chapter describes all registers of ANEG in detail.

Auto-Negotiation Control (Register 7.0)

The register controls the main function of Auto-Negotiation as defined in Clause 45. See IEEE 802.3 45.2.7.1.

This register mirrors register STD_CTRL from Clause 22.

IEEE Standard Register=7.0

ANEG_CTRL

Reset Value

Auto-Negotiation Control (Register 7.0)

3000_H

	15	14	13	12	11	10	9	8						0
	RST	RES3	XNP	ANEG_EN*	RES2		ANEG_RE*	RES1						
	RW	RO	RW	RW	RO		RW	RO						

Field	Bits	Type	Description
RST	15	RW	Reset Resets entire PHY to its default state. Active links are terminated. This is a self-clearing bit: GPY firmware sets it to zero by the hardware after reset is completed. 0 _B NORMAL GPY Normal Operation 1 _B RESET GPY Reset
RES3	14	RO	Reserved Value always zero, writes ignored.
XNP	13	RW	Extended Next Page Control 0 _B ZERO Extended Next Page is disabled 1 _B ONE Extended Next Page is enabled
ANEG_ENAB	12	RW	Auto-Negotiation Enable Enable the Auto-Negotiation process to determine the link configuration. Bit 7.0.12 is a copy of bit 0.12 in register 0 (STD_CTRL) (see 22.2.4.1.4). 0 _B ZERO disable auto-negotiation process 1 _B ONE enable auto-negotiation process
RES2	11:10	RO	Reserved Value always zero, writes ignored.
ANEG_RESTART	9	RW	Restart Auto-Negotiation The Auto-Negotiation process is restarted by setting bit 7.0.9 to one. Bit 7.0.9 is a mirror of bit 0.9 in register 0 (STD_CTRL) (see IEEE 802.3 22.2.4.1.7). Completion of ANEG is indicated in bit 0.1.5 and 7.1.5. 0 _B ZERO Normal Operation 1 _B RESTART Restart Auto-Negotiation process
RES1	8:0	RO	Reserved Value always zero, writes ignored

Auto-Negotiation Status (Register 7.1)

All the bits in the ANEG_STA status register are read only, and correspond to the outcome or current status of the Auto-Negotiation process.

IEEE Standard Register=7.1

ANEG_STAT

Reset Value

Auto-Negotiation Status (Register 7.1)

0008_H

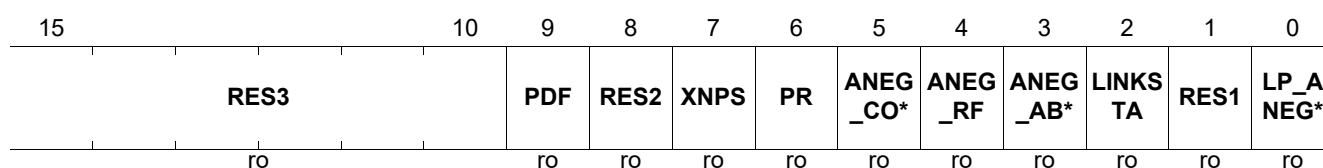

Field	Bits	Type	Description
RES3	15:10	RO	Reserved Value always zero, writes ignored.
PDF	9	RO	Parallel detection fault 0 _B NOFAULT No fault was detected. 1 _B FAULT Fault is detected via the parallel detection
RES2	8	RO	Reserved Value always zero, writes ignored
XNPS	7	RO	Extended Next Page Status When set to 1, bit 7.1.7 indicates that both the GPY and the link partner have indicated support for Extended Next Page. When set to 0, bit 7.1.7 indicates that Extended Next Page will not be used. 0 _B ZERO Extended Next Page is not allowed. 1 _B ONE Extended Next Page format is used.
PR	6	RO	Page Received The page received bit (7.1.6) is set to 1 to indicate that a new link codeword has been received and stored in the AN LP Base Page ability registers 7.19 or AN LP XNP ability registers 7.25 to 7.27. 0 _B ZERO A page has not been received 1 _B ONE A page has been received
ANEG_COMP LETE	5	RO	Auto-Negotiation Complete When read as a 1, bit 7.1.5 indicates that the Auto-Negotiation process has been completed, and that the contents of the Auto-Negotiation registers 7.16 and 7.19 are valid. When read as a zero, bit 7.1.5 indicates that the Auto-Negotiation process has not been completed, and that the contents of 7.19, 7.22 through 7.27, and 7.33 registers are as defined by the current state of the Auto-Negotiation protocol, or as written by manual configuration. 0 _B ZERO Auto-Negotiation process has not completed 1 _B ONE Auto-Negotiation process has completed

Field	Bits	Type	Description (cont'd)
ANEG_RF	4	RO	Remote Fault When read as one, bit 7.1.4 indicates that a remote fault condition has been detected. Bit 7.1.4 is a copy of bit 1.4 in register 1, device 0 (see 22.2.4). 0 _B NORMAL No remote fault condition detected 1 _B FAULT Remote fault condition detected
ANEG_ABLE	3	RO	Auto-Negotiation Ability Bit 7.1.3 is a copy of bit 1.3 in register 1 (see 22.2.4). This is the ANEG ability of the GPY. 0 _B UNABLE PHY is not able to perform Auto-Negotiation 1 _B ABLE PHY is able to perform Auto-Negotiation
LINKSTA	2	RO	Link Status When read as a one, bit 7.1.2 indicates that the PMA/PMD has determined that a valid link has been established. This bit is a duplicate of the PMA/PMD link status bit in 1.1.2. This bit latches low, so does not represent the current status but can be used to indicate link drop since the last read from the management interface. Reading this bit from MDIO resets the bit to the current value of the link. 0 _B DOWN Link is down 1 _B UP Link is Up
RES1	1	RO	Value always zero, write ignored
LP_ANEG_ABLE	0	RO	Link partner auto-negotiation ability 0 _B UNABLE Link partner is not capable of auto-negotiation. 1 _B ABLE Link partner is capable of auto-negotiation

PHY Identifier 1 (Register 7.2)

ANEG_DEVID1		Reset Value
PHY Identifier 1 (Register 7.2)		67C9_H
15	OUI	0
	ro	

Field	Bits	Type	Description
OUI	15:0	RO	Organizationally Unique Identifier

PHY Identifier 2 (Register 7.3)

Organizationally Unique Identifier
IEEE Standard Register=7.3

ANEG_DEVID2

PHY Identifier 2 (Register 7.3)

Reset Value

DC00_H

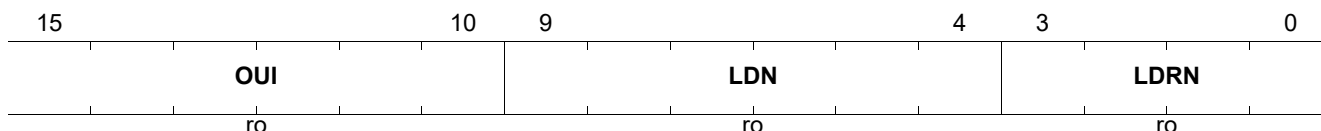

Field	Bits	Type	Description
OUI	15:10	RO	Organizationally Unique Identifier
LDN	9:4	RO	Device Number Specifies the device number ¹⁾ to distinguish between several products.
LDRN	3:0	RO	Device Number Specifies the device revision number ¹⁾ to distinguish between several versions of this device

1) For the device specific reset value, refer to Product Naming table in the [Package Outline](#) chapter.

Device in Package 1 (Register 7.5)

IEEE Standard Register=7.5

ANEG_DIP1

Device in Package 1 (Register 7.5)

Reset Value

008B_H

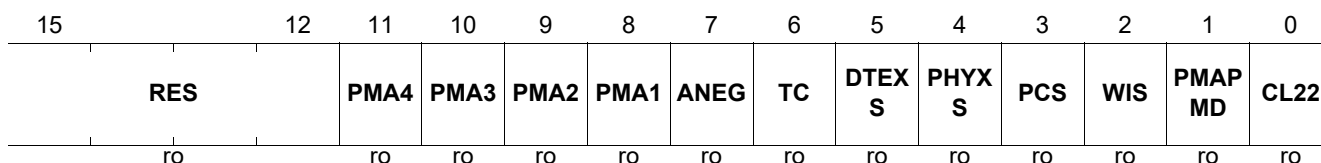

Field	Bits	Type	Description
RES	15:12	RO	Reserved Ignore on Read
PMA4	11	RO	Separate PMA4 present in package 0 _B ABSENT Separate PMA4 not present in package 1 _B PRESENT Separate PMA4 present in package
PMA3	10	RO	Separate PMA3 present in package 0 _B ABSENT Separate PMA3 not present in package 1 _B PRESENT Separate PMA3 present in package

Field	Bits	Type	Description (cont'd)
PMA2	9	RO	Separate PMA2 present in package 0 _B ABSENT Separate PMA2 not present in package 1 _B PRESENT Separate PMA2 present in package
PMA1	8	RO	Separate PMA1 present in package 0 _B ABSENT Separate PMA1 not present inn package 1 _B PRESENT Separate PMA1 present in package
ANEG	7	RO	Auto-negotiation present in package 0 _B ABSENT ANEG not present inn package 1 _B PRESENT ANEG present in package
TC	6	RO	TC present in package 0 _B ABSENT TC registers not present in package 1 _B PRESENT TC registers present in package
DTEXS	5	RO	DTE XS present in package 0 _B ABSENT DTE XS registers not present in package 1 _B PRESENT DTE XS registers present in package
PHYXS	4	RO	PHYXS present in package 0 _B ABSENT PHYXS registers not present in package 1 _B PRESENT PHYXS registers present in package
PCS	3	RO	PCS present in package 0 _B ABSENT PCS registers not present in package 1 _B PRESENT PCS registers present in package
WIS	2	RO	WIS present in package 0 _B ABSENT WIS registers present in package 1 _B PRESENT WIS registers present in package
PMAPMD	1	RO	PMA PMD presence in package 0 _B ABSENT PMA PMD registers not present in package 1 _B PRESENT PMA PMD registers present in package
CL22	0	RO	Clause 22 register present in package 0 _B ABSENT Clause 22 registers no present in package 1 _B PRESENT Clause 22 registers present in package

Device in Package 2 (Register 7.6)

IEEE Standard Register=7.6

ANEG_DIP2

Reset Value

Device in Package 2 (Register 7.6)

C000_H

15			14			13			12			0		
VSPE C2			VSPE C1			CL22E XT			RES					
ro			ro			ro			ro					

Field	Bits	Type	Description
VSPEC2	15	RO	Vendor Specific Device 2 present in package 0 _B ABSENT Vendor Specific Device 2 not present in package 1 _B PRESENT Vendor Specific Device 2 present in package
VSPEC1	14	RO	Vendor Specific Device 1 present in package 0 _B ABSENT Vendor Specific Device 1 not present in package 1 _B PRESENT Vendor Specific Device 1 present in package
CL22EXT	13	RO	Clause 22 extension present in package 0 _B ABSENT Clause 22 extension not present in package 1 _B PRESENT Clause 22 extension present in package
RES	12:0	RO	Reserved Ignore on read

AN package identifier (Register 7.14)

IEEE Standard Register=7.14

ANEG_PACKID1

Reset Value

AN package identifier (Register 7.14)

67C9_H

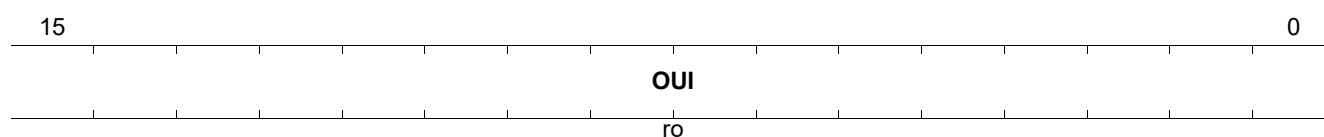

Field	Bits	Type	Description
OUI	15:0	RO	Organizationally Unique Identifier Organizationally Unique Identifier Bits 3:18

AN package identifier (Register 7.15)

IEEE Standard Register=7.15

ANEG_PACKID2

Reset Value

AN package identifier (Register 7.15)

DC00_H

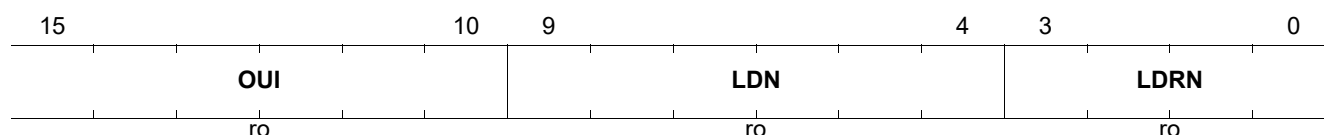

Field	Bits	Type	Description
OUI	15:10	RO	Organizationally Unique Identifier Bits 19:24
LDN	9:4	RO	Device Number Specifies the device number ¹⁾ to distinguish between several products.

Field	Bits	Type	Description (cont'd)
LDRN	3:0	RO	Device Number Specifies the device revision number ¹⁾ to distinguish between several versions of this device

1) For the device specific reset value, refer to Product Naming table in the [Package Outline](#) chapter.

ANEG Adv. for GPY (Register 7.16)

This register is a copy of the Auto-Negotiation advertisement register (Register 4). A read to the AN advertisement register (7.16) reports the value of the Auto-Negotiation advertisement register (Register 4); writes to the AN advertisement register (7.16) cause a write to occur to the Auto-Negotiation advertisement register (Register 4).
IEEE Standard Register=7.16

ANEG_ADV

Reset Value

ANEG Adv. for GPY (Register 7.16)

01E1_H

15				14				13				12				11				5				4				0			
NP				RES				RF				XNP				TAF								SF							
rw				ro				rw				rw				rw								rw							

Field	Bits	Type	Description
NP	15	RW	Next Page Able 0 _B INACTIVE No Next page allowed 1 _B ACTIVE Additional Next Page will follow.
RES	14	RO	Reserved Write as zero, ignore on read.
RF	13	RW	Remote Fault The remote fault bit allows indication of a fault to the link partner. See IEEE 802.3 28.2.1.2.4.
XNP	12	RW	Indicates that GPY supports transmission of Extended Next Pages 0 _B UNABLE GPY is XNP unable 1 _B ABLE GPY is XNP able
TAF	11:5	RW	Technology Ability Field The technology ability field is an 8-bit wide field containing information indicating supported technologies. GPY supports 10BASE-T (Half and Full Duplex), 100BASE-TX (Half and Full Duplex) and both symmetric and asymmetric PAUSE. 40 _H PS_ASYM Advertise asymmetric pause 20 _H PS_SYM Advertise symmetric pause 10 _H DBT4 Advertise 100BASE-T4 08 _H DBT_FDX Advertise 100BASE-TX full duplex 04 _H DBT_HDX Advertise 100BASE-TX half duplex 02 _H XBT_FDX Advertise 10BASE-T full duplex 01 _H XBT_HDX Advertise 10BASE-T half duplex

Field	Bits	Type	Description (cont'd)
SF	4:0	RW	Selector Field This field is always set to 1 because GPY only supports 802.3 Ethernet standard. 00001 _B IEEE8023 IEEE802.3Select the IEEE 802.3 technology

AN Link Partner Base Page Ability (Register 7.19)

Register 7.19 is a copy of register 5 from Clause 28. It contains the Base Page received from the link partner. All of the bits in the AN LP Base Page ability register are read only.

IEEE Standard Register=7.19

ANEG_LP_BP_AB

AN Link Partner Base Page Ability (Register 7.19)

Reset Value

01E0_H

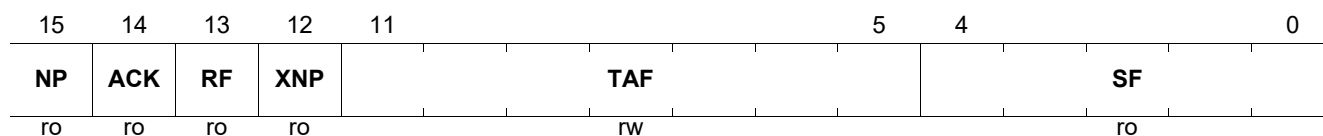

Field	Bits	Type	Description
NP	15	RO	Link Partner Next Page Next page request indication from the link partner. See IEEE 802.3 28.2.1.2.6. 0 _B INACTIVE No Next Page to Follow 1 _B ACTIVE Additional Next Page will follow
ACK	14	RO	Link Partner Acknowledge Acknowledgement indication from the link partner's link code word. See IEEE 802.3 28.2.1.2.5. 0 _B INACTIVE Device did not successfully receive its Link Partner's LCW 1 _B ACTIVE The device has successfully received its link partner's link code word
RF	13	RO	Link Partner Remote Fault Remote fault indication from the link partner. See IEEE 802.3 28.2.1.2.4. 0 _B NONE Remote fault is not indicated by the link partner 1 _B FAULT Remote fault is indicated by the link partner
XNP	12	RO	Link Partner XNP Ability 0 _B UNABLE Link Partner is not XNP able 1 _B ABLE Link Partner is XNP able

Field	Bits	Type	Description (cont'd)
TAF	11:5	RW	Technology Ability Field Indicate the link partner's supported technologies received in base page. 40 _H PS_ASYM Advertise asymmetric pause 20 _H PS_SYM Advertise symmetric pause 10 _H DBT4 Advertise 100BASE-T4 08 _H DBT_FDX Advertise 100BASE-TX full duplex 04 _H DBT_HDX Advertise 100BASE-TX half duplex 02 _H XBT_FDX Advertise 10BASE-T full duplex 01 _H XBT_HDX Advertise 10BASE-T half duplex
SF	4:0	RO	Link Partner Selector Field The selector field represents one of the 32 possible messages with encoding definitions shown in IEEE 802.3 Annex 28A. 0x00 = Reserved 0x01 = IEEE 802.3 0x02 = IEEE 802.9 ISLAN-16T 0x03 = IEEE 802.5 0x04 = IEEE 1394 0x05 -> 0x1F = Reserve 00001 _B IEEE8023 IEEE802.3 Select the IEEE802.3 technology

ANEG Local Dev XNP TX1 (Register 7.22)

ANEG_XNP_TX1 **Reset Value**
ANEG Local Dev XNP TX1 (Register 7.22) **0000_H**

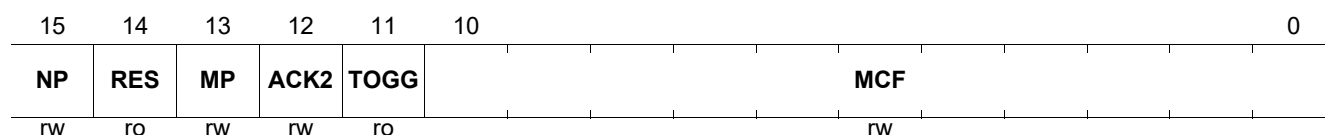

Field	Bits	Type	Description
NP	15	RW	Next Page When NP bit is set, the GPY requests to transmit one additional page. Next Page transmission ends when both ends of a link segment set their Next Page bits to logic zero, indicating that neither has anything additional to transmit. See IEEE 802.3 28.2.3.4. 0 _B INACTIVE No Next Page to Follow 1 _B ACTIVE Additional next page(s) will follow
RES	14	RO	Reserved Write as zero, ignore on read.

Field	Bits	Type	Description (cont'd)
MP	13	RW	Message Page Message Page (MP) is used by the Next Page function to differentiate a Message Page from an Unformatted Page. Only message pages are used by GPY. 0 _B UNFOR Unformatted Page 1 _B MESSG Message Page
ACK2	12	RW	Acknowledge 2 Not used during GPY auto negotiation. 0 _B INACTIVE Device cannot comply with message 1 _B ACTIVE Device will comply with message
TOGG	11	RO	Toggle The Toggle bit is used to ensure proper synchronization between the GPY and the Link Partner. See IEEE 802.3 28.2.3.4. 0 _B ZERO Previous value of the Tx LCW was ONE 1 _B ONE Previous value of the Tx LCW was ZERO
MCF	10:0	RW	Message Code Field When Message Page bit is set to 1 (7.16.1), this field is the Message Code Field of a message page used in Next Page exchange. The message codes are described in IEEE802.3 Appendix 28C. It is used to indicate the type of message in UCF1 and UCF2. 0x0 = Reserved 0x1 = Null message 0x2 = One Unformatted Page (UP) with TAF follows 0x3 = Two UPs with TAF follows 0x4 = Remote fault details message 0x5 = OUI message 0x6 = PHY ID message 0x7 = 100BASE-T2 message 0x8 = 1000BASE-T message 0x9 = MULTIGBASE-T message 0xA = EEE technology capability follows in next UP 0xB = OUI XNP

ANEG Local Dev XNP TX2 (Register 7.23)

Unformatted Code field 1 contains Seed information and advertises support of 1GBT full duplex and half duplex.

See 28.2.3.4

IEEE Standard Register=7.23

ANEG_XNP_TX2

Reset Value

ANEG Local Dev XNP TX2 (Register 7.23)

0000_H

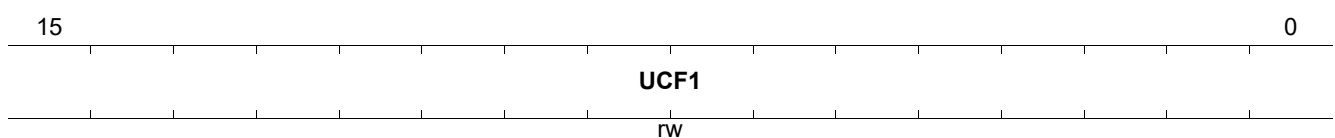

Field	Bits	Type	Description
UCF1	15:0	RW	Unformatted Code Field 1 Transmits Master-Slave Seed bit to facilitate Auto-negotiation resolution, port type and duplex capability.

ANEG Local Dev XNP TX3 (Register 7.24)

Unformatted Code field 2 - Register 7.24

See 28.2.3.4

IEEE Standard Register=7.24

ANEG_XNP_TX3

Reset Value

ANEG Local Dev XNP TX3 (Register 7.24)

0000_H

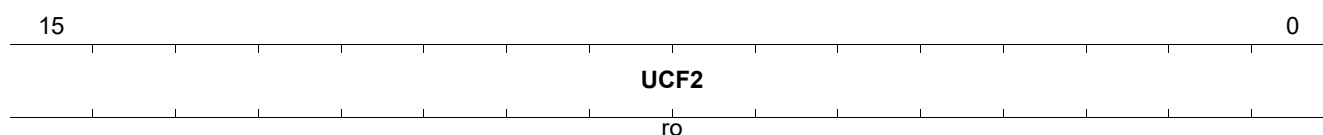

Field	Bits	Type	Description
UCF2	15:0	RO	Unformatted Code Field 2

ANEG Link Partner XNP RX (Register 7.25)

IEEE Standard Register=7.25

ANEG_LP_XNP_AB1

Reset Value

ANEG Link Partner XNP RX (Register 7.25)

0000_H

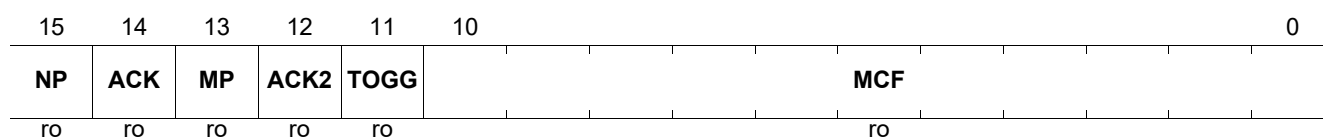

Field	Bits	Type	Description
NP	15	RO	Link Partner Next Page See 28.2.3.4.3 Next Page (NP) is used by the Next Page function to indicate whether or not this is the last Next Page to be transmitted. 0 _B INACTIVE Last Page 1 _B ACTIVE Additional next page(s) will follow
ACK	14	RO	Link Partner Acknowledge As defined in 28.2.1.2.5. Acknowledge (Ack) is used by the Auto-Negotiation function to indicate that GPY has successfully received its Link Partner's link codeword.

Field	Bits	Type	Description (cont'd)
MP	13	RO	Link Partner Message Page Indicates that the content of MCF is either an unformatted page or a formatted message. See IEEE 802.3 28.2.3.4. 0 _B UNFOR Unformatted Page 1 _B MESSG Message Page
ACK2	12	RO	Link Partner Acknowledge 2 See IEEE 802.3 28.2.3.4. 0 _B INACTIVE Device cannot comply with message 1 _B ACTIVE Device will comply with message
TOGG	11	RO	Link Partner Toggle See IEEE 802.3 28.2.3.4. Set to the opposite of TOGG bit in previous page. 0 _B ZERO Previous value of the TX LCW was ONE 1 _B ONE Previous value of the TX LCW was ZERO
MCF	10:0	RO	Link Partner Message Code Field Indicate the type of Message Code. See IEEE802.3 28.2.3.4 009 _H MC_2G5BT Message Code for 2G5BT

ANEG Link Partner XNP RX (Register 7.26)

IEEE Standard Register=7.26

ANEG_LP_XNP_AB2

Reset Value

ANEG Link Partner XNP RX (Register 7.26)

0000_H

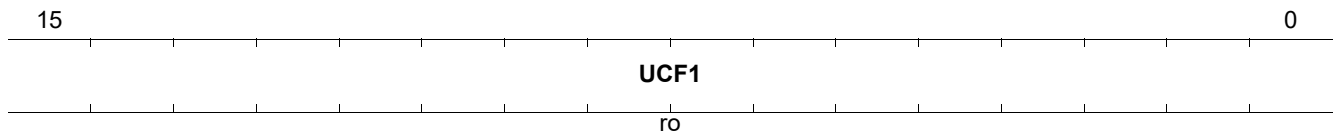

Field	Bits	Type	Description
UCF1	15:0	RO	Unformatted Code Field 1 See 28.2.3.4

ANEG Link Partner XNP RX (Register 7.27)

IEEE Standard Register=7.27

ANEG_LP_XNP_AB3

ANEG Link Partner XNP RX (Register 7.27)

Reset Value

0000_H

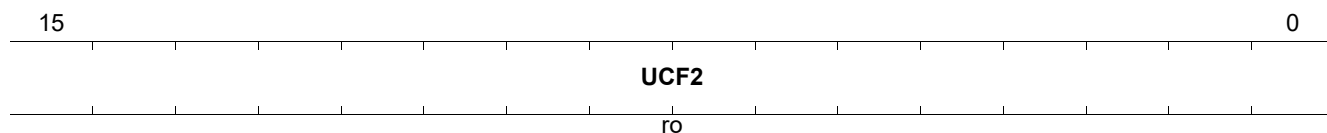

Field	Bits	Type	Description
UCF2	15:0	RO	Unformatted Code Field 2 See 28.2.3.4

MULTI GBT AN Control Register (Register 7.32)

Advertise the GPY Capabilities

IEEE Standard Register=7.32

ANEG_MGBT_AN_CTRL

MULTI GBT AN Control Register (Register 7.32)

Reset Value

0002_H

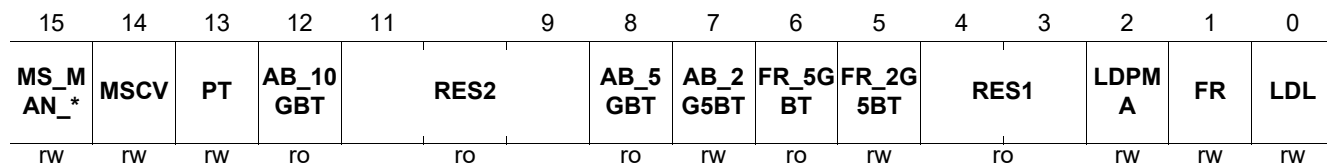

Field	Bits	Type	Description
MS_MAN_EN	15	RW	Master Slave Config Manual Config Enable 0 _B ANEG ANEG is used to determine Master-Slave selection 1 _B MAN Manual Config, MSCV bit determines Master-Slave
MSCV	14	RW	Master Slave Config Value 0 _B SLAVE Manual set to SLAVE 1 _B MASTER Manual set to MASTER
PT	13	RW	Port Type 0 _B MASTER Preference as Master - Single Port Device 1 _B SLAVE Preference as Slave - Multiport Device
AB_10GBT	12	RO	10GBASE-T Ability Not Supported - always 0
RES2	11:9	RO	Reserved Value always zero, writes ignored.

Field	Bits	Type	Description (cont'd)
AB_5GBT	8	RO	5GBASE-T ability Not supported by GPY 0 _B UNABLE Do not Advertise PHY as 5GBASE-T capable 1 _B ABLE Advertise PHY as 5GBASE-T capableNot supported
AB_2G5BT	7	RW	2.5 G BASE-T ability Not supported by GPY. 0 _B UNABLE Do not Advertise PHY as 2.5GBASE-T capable 1 _B ABLE Advertise PHY as 2.5GBASE-T capable
FR_5GBT	6	RO	5 G BASE-T Fast Retrain Ability Not supported by GPY. See 45.2.7.10 bz 0 _B UNABLE Do not Advertise PHY as 5GBT Fast retrain able 1 _B ABLE Advertise PHY as 5GBASE-T Fast Retrain capableNot supported
FR_2G5BT	5	RW	2.5 G BASE-T Fast Retrain Ability Not supported by GPY. See 45.2.7.10 bz 0 _B UNABLE Do not Advertise PHY as 2.5G Fast Retrain Able 1 _B ABLE Advertise PHY as 2.5G Fast retrain able
RES1	4:3	RO	Reserved Value always zero, writes ignored.
LDPMA	2	RW	GPY PMA training reset request If set to one the GPY expects the link partner to reset the PMA training PRBS for every PMA training frame. If bit is zero then the GPY expects link partner to run PMA training PRBS continuously through every PMA training frame
FR	1	RW	Fast Retrain Ability
LDL	0	RW	GPY Loop Timing Ability

MultiGBASE-T AN Status register (Register 7.33)

IEEE Standard Register=7.33

ANEG_MGBT_AN_STA

MultiGBASE-T AN Status register (Register 7.33)

Reset Value

0000_H

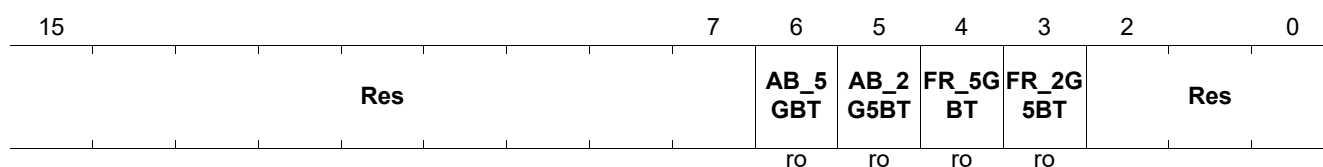

Field	Bits	Type	Description
AB_5GBT	6	RO	5G BASE-T Ability of Link Partner This bit is only valid after link is established and ANEG completed. 0 _B UNABLE Link partner is not capable of 5GBASE-T 1 _B ABLE Link partner is capable of 5GBASE-T

Field	Bits	Type	Description (cont'd)
AB_2G5BT	5	RO	2.5 G BASE-T Ability of Link Partner This bit is only valid after link is established and ANEG completed (bit 7.1.5 is set to 1). 0 _B UNABLE Link partner is not capable of 2.5GBASE-T 1 _B ABLE Link partner is capable of 2.5GBASE-T
FR_5GBT	4	RO	5 G BASE-T Fast Retrain Ability of Link Partner This bit is only valid after link is established and ANEG completed. 0 _B UNABLE Link partner is not capable of 5GBT fast retrain 1 _B ABLE Link partner is capable of 5GBASE-T fast retrain
FR_2G5BT	3	RO	2.5 G BASE-T Fast Retrain Ability of Link Partner This bit is only valid after link is established and ANEG completed (bit 7.1.5 is set to 1). 0 _B UNABLE Link partner is not capable of 2.5GBT fast retrain 1 _B ABLE Link partner is capable of 2.5GBASE-T fast retrain

EEE Advertisement 1 (Register 7.60)

IEEE Standard Register=7.60

ANEG_EEE_AN_ADV1

EEE Advertisement 1 (Register 7.60)

Reset Value

0006_H

15	7	6	5	4	3	2	1	0				
Res						EEE_1 0G*	EEE_1 0G*	EEE_1 00*	EEE_1 0G*	EEE_1 00*	EEE_1 00*	Res
						ro	ro	ro	ro	rw	rw	

Field	Bits	Type	Description
EEE_10GBKR	6	RO	Support of 10GBASE-KR EEE 0 _B DISABLED This PHY mode is not supported for EEE 1 _B ENABLE This PHY mode is supported for EEE
EEE_10GBKX 4	5	RO	Support of 10GBASE-KX4 EEE 0 _B DISABLED This PHY mode is not supported for EEE 1 _B ENABLE This PHY mode is supported for EEE
EEE_1000BKX	4	RO	Support of 1000BASE-KX EEE 0 _B DISABLED This PHY mode is not supported for EEE 1 _B ENABLE This PHY mode is supported for EEE
EEE_10GBT	3	RO	Support of 10GBASE-T EEE 0 _B DISABLED This PHY mode is not supported for EEE 1 _B ENABLE This PHY mode is supported for EEE
EEE_1000BT	2	RW	Support of 1000BASE-T EEE 0 _B DISABLED This PHY mode is not supported for EEE 1 _B ENABLE This PHY mode is supported for EEE

Field	Bits	Type	Description (cont'd)
EEE_100BTX	1	RW	Support of 100BASE-TX EEE 0 _B DISABLED This PHY mode is not supported for EEE 1 _B ENABLE This PHY mode is supported for EEE

EEE Link Partner Ability 1 (Register 7.61)

After the AN process is completed, this register reflects the contents of the link partner's EEE advertisement register. The definitions are the same as for the EEE AN advertisement 1 register.

IEEE Standard Register=7.61

All of the bits in the EEE LP ability 1 register are read only. A write operation to the EEE LP advertisement register has no effect.

ANEG_EEE_AN_LPAB1

Reset Value

EEE Link Partner Ability 1 (Register 7.61)

0000_H

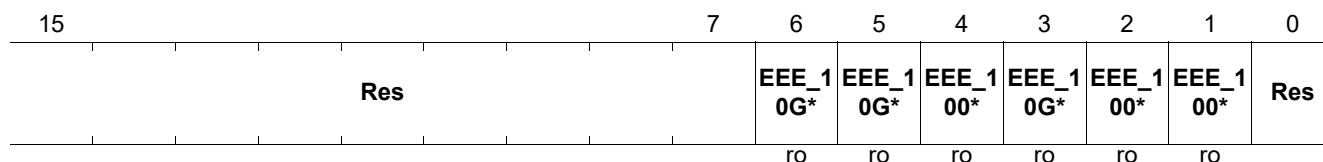

Field	Bits	Type	Description
EEE_10GBKR	6	RO	Support of 10GBASE-KR EEE 0 _B DISABLED This PHY mode is not supported for EEE 1 _B ENABLE This PHY mode is supported for EEE
EEE_10GBKX 4	5	RO	Support of 10GBASE-KX4 EEE 0 _B DISABLED This PHY mode is not supported for EEE 1 _B ENABLE This PHY mode is supported for EEE
EEE_1000BKX	4	RO	Support of 1000BASE-KX EEE 0 _B DISABLED This PHY mode is not supported for EEE 1 _B ENABLE This PHY mode is supported for EEE
EEE_10GBT	3	RO	Support of 10GBASE-T EEE 0 _B DISABLED This PHY mode is not supported for EEE 1 _B ENABLE This PHY mode is supported for EEE
EEE_1000BT	2	RO	Support of 1000BASE-T EEE 0 _B DISABLED This PHY mode is not supported for EEE 1 _B ENABLE This PHY mode is supported for EEE
EEE_100BTX	1	RO	Support of 100BASE-TX EEE 0 _B DISABLED This PHY mode is not supported for EEE 1 _B ENABLE This PHY mode is supported for EEE

EEE Advertisement 2 (Register 7.62)

EEE advertisement 2 register is a continuation of EEE advertisement 1 register.

IEEE Standard Register=7.62

ANEG_EEE_AN_ADV2

Reset Value

EEE Advertisement 2 (Register 7.62)

0000_H

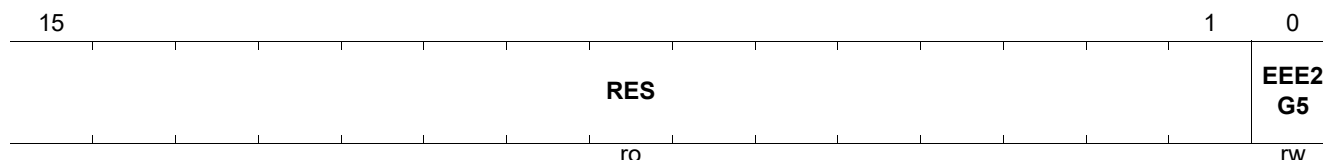

Field	Bits	Type	Description
RES	15:1	RO	Reserved
EEE2G5	0	RW	Advertise 2G5BT EEE capability 0 _B DISABLED This PHY mode does not advertise 2G5BT EEE 1 _B ENABLE This PHY mode does advertise 2G5BT EEE

EEE Link Partner Ability 2 (Register 7.63)

When the AN and training processes is completed, this register reflects the contents of the link partner's EEE advertisement 2 register.

IEEE Standard Register=7.63

All of the bits in the EEE LP ability 2 register are read-only. A write to the EEE LP ability 2 register will have no effect.

ANEG_EEE_LP_AB2

Reset Value

EEE Link Partner Ability 2 (Register 7.63)

0001_H

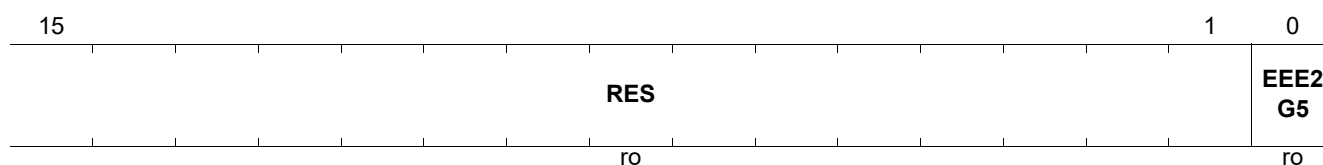

Field	Bits	Type	Description
RES	15:1	RO	Reserved
EEE2G5	0	RO	Link Partner advertised 2G5BT EEE capability 0 _B DISABLED LP not 2G5BT EEE capable 1 _B ENABLE LP 2G5BT EEE capable

6.4 Vendor Specific 1 Device for MMD=0x1E

This register file contains GPY specific register for MMD=30 (decimal)

Table 24 Registers Overview

Register Short Name	Register Long Name	Reset Value
VSPEC1_LED0	Configuration for LED Pin 0 (Register 30.1)	0310 _H
VSPEC1_LED1	Configuration for LED Pin 1 (Register 30.2)	0320 _H
VSPEC1_LED2	Configuration for LED Pin 2 (Register 30.3)	0340 _H
VSPEC1_LED3	Configuration for LED Pin 3 (Register 30.4)	0380 _H
VSPEC1_SGMII_CTRL	Chip Level SGMII control register (Register 30.8)	34DA _H
VSPEC1_SGMII_STAT	Chip Level SGMII status register (Register 30.9)	8008 _H
VSPEC1_NBT_DS_CTRL	NBASE-T Downshift Control Register (Register 30.10)	0400 _H
VSPEC1_NBT_DS_STA	NBASE-T Downshift Status Register (Register 30.11)	0000 _H
VSPEC1_PM_CTRL	Packet Manager Control (Register 30.12)	0003 _H
VSPEC1_TEMP_STA	Temperature code (Register 30.14)	0000 _H
VSPEC1_IMASK	MACSec Interrupt Mask Register (Register 30.17)	0000 _H
VSPEC1_ISTAT	MACSec Interrupt Mask Register (Register 30.18)	0000 _H
VSPEC1_LANE_ASP_MAP	ASP Mapping to Physical Lanes(Register 30.20)	00E4 _H

6.4.1 Vendor Specific 1 Device for MMD=0x1E

This chapter describes all registers of VSPEC1 in detail.

Configuration for LED Pin 0 (Register 30.1)

This register configures the behavior of the LED0 depending on pre-defined states or events the PHY has entered into or raised. Since more than one event/state can be active at the same time, more than one function might apply simultaneously. The priority from highest to lowest is given by the order PULSE, BLINKS, BLINKF, CON.

IEEE Standard Register=30.1

VSPEC1_LED0

Reset Value

Configuration for LED Pin 0 (Register 30.1)

0310_H

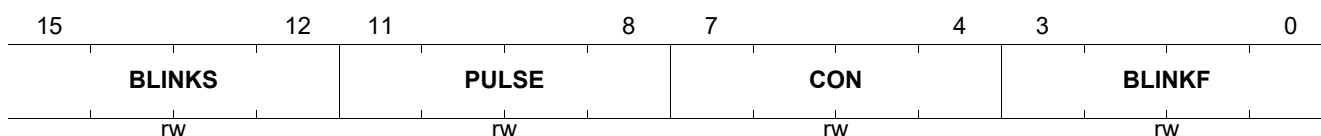

Field	Bits	Type	Description
BLINKS	15:12	RW	<p>Slow Blinking Configuration</p> <p>The Blink-S field selects in which PHY states the LED blinks with the pre-defined slow frequency. Each bit mask indicates a link speed. Combinations of the bit mask below can be used to provide a combination of link speed states to enable the behavior.</p> <p>0000_BNONE Not Active 0001_BLINK10 Blink when Link is 10 Mbit/s 0010_BLINK100 Blink when Link is 100 Mbit/s 0100_BLINK1000 Blink when Link is 1000 Mbit/s 1000_BLINK2500 Blink when Link is 2500 Mbit/s</p>
PULSE	11:8	RW	<p>Pulsing Configuration</p> <p>The pulse field is a mask field in which certain events can be combined, e.g. TXACT RXACT, to generate a pulse on the LED when such an event is detected.</p> <p>0000_BNONE No pulsing 0001_BTXACT Transmit activity 0010_BRXACT Receive activity 0100_BCOL Collision 1000_BNO_CON Constant ON behavior is switched off</p>
CON	7:4	RW	<p>Constant On Configuration</p> <p>The Constant-ON field selects in which PHY states the LED is constantly on. Each bit mask indicates a link speed. Combinations of the bit mask below can be used to provide a combination of link speed states to enable the behavior.</p> <p>0000_BNONE Not Active 0001_BLINK10 On when Link is 10 Mbit/s 0010_BLINK100 On when Link is 100 Mbit/s 0100_BLINK1000 On when Link is 1000 Mbit/s 1000_BLINK2500 On when Link is 2500 Mbit/s</p>
BLINKF	3:0	RW	<p>Fast Blinking Configuration</p> <p>The Blink-F Field selects in which PHY states the LED blinks with the pre-defined fast frequency. Each bit mask indicates a link speed. Combinations of the bit mask below can be used to provide a combination of link speed states to enable the behavior.</p> <p>0000_BNONE No Active 0001_BLINK10 Blink when Link is 10 Mbit/s 0010_BLINK100 Blink when Link is 100 Mbit/s 0100_BLINK1000 Blink when Link is 1000 Mbit/s 1000_BLINK2500 Blink when Link is 2500 Mbit/s</p>

Configuration for LED Pin 1 (Register 30.2)

Configuration Register for LED Pin 1

IEEE Standard Register=30.2

VSPEC1_LED1

Reset Value

Configuration for LED Pin 1 (Register 30.2)

0320_H

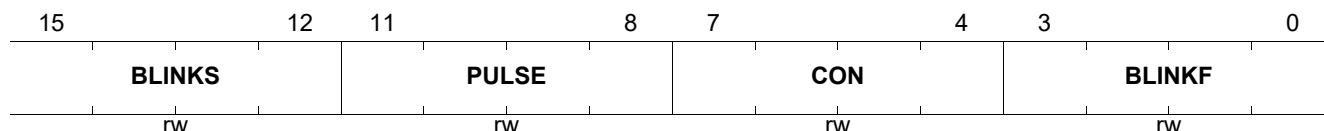

Field	Bits	Type	Description
BLINKS	15:12	RW	<p>Slow Blinking Configuration</p> <p>The Blink-S field selects in which PHY states the LED blinks with the pre-defined slow frequency. Each bit mask indicates a link speed. Combinations of the bit mask below can be used to provide a combination of link speed states to enable the behavior.</p> <p>0000_BNONE Not Active 0001_BLINK10 Blink when Link is 10 Mbit/s 0010_BLINK100 Blink when Link is 100 Mbit/s 0100_BLINK1000 Blink when Link is 1000 Mbit/s 1000_BLINK2500 Blink when Link is 2500 Mbit/s</p>
PULSE	11:8	RW	<p>Pulsing Configuration</p> <p>The pulse field is a mask field by which certain events can be combined, e.g. TXACT RXACT, to generate a pulse on the LED when such an event is detected.</p> <p>0000_BNONE No pulsing 0001_BTXACT Transmit activity 0010_BRXACT Receive activity 0100_BCOL Collision 1000_BNO_CON Constant ON behavior is switched off</p>
CON	7:4	RW	<p>Constant On Configuration</p> <p>The Constant-ON field selects in which PHY states the LED is constantly on. Each bit mask indicates a link speed. Combinations of the bit mask below can be used to provide a combination of link speed states to enable the behavior.</p> <p>0000_BNONE Not Active 0001_BLINK10 On when Link is 10 Mbit/s 0010_BLINK100 On when Link is 100 Mbit/s 0100_BLINK1000 On when Link is 1000 Mbit/s 1000_BLINK2500 On when Link is 2500 Mbit/s</p>

Field	Bits	Type	Description (cont'd)
BLINKF	3:0	RW	Fast Blinking Configuration The Blink-F Field selects in which PHY states the LED blinks with the pre-defined fast frequency. Each bit mask indicates a link speed. Combinations of the bit mask below can be used to provide a combination of link speed states to enable the behavior. 0000 _B NONE Not Active 0001 _B LINK10 Blink when Link is 10 Mbit/s 0010 _B LINK100 Blink when Link is 100 Mbit/s 0100 _B LINK1000 Blink when Link is 1000 Mbit/s 1000 _B LINK2500 Blink when Link is 2500 Mbit/s

Configuration for LED Pin 2 (Register 30.3)

Configuration Register for LED Pin 2

IEEE Standard Register=30.3

VSPEC1_LED2

Reset Value

Configuration for LED Pin 2 (Register 30.3)

0340_H

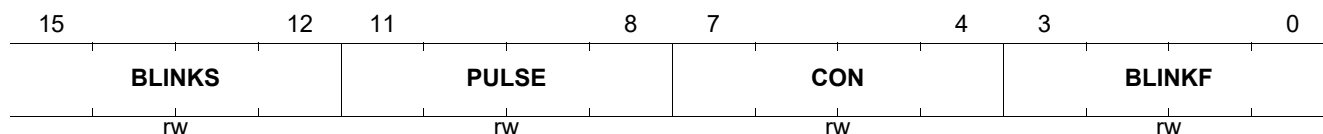

Field	Bits	Type	Description
BLINKS	15:12	RW	Slow Blinking Configuration The Blink-S field selects in which PHY states the LED blinks with the pre-defined slow frequency. Each bit mask indicates a link speed. Combinations of the bit mask below can be used to provide combination of link speed states to enable the behavior. 0000 _B NONE Not Active 0001 _B LINK10 Blink when Link is 10 Mbit/s 0010 _B LINK100 Blink when Link is 100 Mbit/s 0100 _B LINK1000 Blink when Link is 1000 Mbit/s 1000 _B LINK2500 Blink when Link is 2500 Mbit/s
PULSE	11:8	RW	Pulsing Configuration The pulse field is a mask field by which certain events can be combined, e.g. TXACT RXACT, to generate a pulse on the LED when such an event is detected. 0000 _B NONE No pulsing 0001 _B TXACT Transmit activity 0010 _B RXACT Receive activity 0100 _B COL Collision 1000 _B NO_CON Constant ON behavior is switched off

Field	Bits	Type	Description (cont'd)
CON	7:4	RW	<p>Constant On Configuration The Constant-ON field selects in which PHY states the LED is constantly on. Each bit mask indicates a link speed. Combinations of the bit mask below can be used to provide combination of link speed states to enable the behavior.</p> <p>0000_BNONE Not Active 0001_BLINK10 On when Link is 10 Mbit/s 0010_BLINK100 On when Link is 100 Mbit/s 0100_BLINK1000 On when Link is 1000 Mbit/s 1000_BLINK2500 On when Link is 2500 Mbit/s</p>
BLINKF	3:0	RW	<p>Fast Blinking Configuration The Blink-F Field selects in which PHY states the LED blinks with the pre-defined fast frequency. Each bit mask indicates a link speed. Combinations of the bit mask below can be used to provide a combination of link speed states to enable the behavior.</p> <p>0000_BNONE Not Active 0001_BLINK10 Blink when Link is 10 Mbit/s 0010_BLINK100 Blink when Link is 100 Mbit/s 0100_BLINK1000 Blink when Link is 1000 Mbit/s 1000_BLINK2500 Blink when Link is 2500 Mbit/s</p>

Configuration for LED Pin 3 (Register 30.4)

Configuration Register for LED Pin 3
IEEE Standard Register=30.4

VSPEC1_LED3

Reset Value

Configuration for LED Pin 3 (Register 30.4)

0380_H

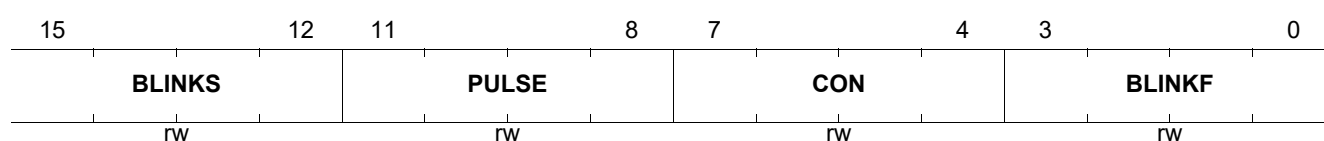

Field	Bits	Type	Description
BLINKS	15:12	RW	<p>Slow Blinking Configuration The Blink-S field selects in which PHY states the LED blinks with the pre-defined slow frequency. Each bit mask indicates a link speed. Combinations of the bit mask below can be used to provide combination of link speed states to enable the behavior.</p> <p>0000_BNONE Not Active 0001_BLINK10 Blink when Link is 10 Mbit/s 0010_BLINK100 Blink when Link is 100 Mbit/s 0100_BLINK1000 Blink when Link is 1000 Mbit/s 1000_BLINK2500 Blink when Link is 2500 Mbit/s</p>

Field	Bits	Type	Description (cont'd)
PULSE	11:8	RW	Pulsing Configuration The pulse field is a mask field by which certain events can be combined, e.g. TXACT RXACT, to generate a pulse on the LED when such an event is detected. 0000 _B NONE No pulsing 0001 _B TXACT Transmit activity 0010 _B RXACT Receive activity 0100 _B COL Collision 1000 _B NO_CON Constant ON behavior is switched off
CON	7:4	RW	Constant On Configuration The Constant-ON field selects in which PHY states the LED is constantly on. Each bit mask indicates a link speed. Combinations of the bit mask below can be used to provide combination of link speed states to enable the behavior. 0000 _B NONE Not Active 0001 _B LINK10 On when Link is 10 Mbit/s 0010 _B LINK100 On when Link is 100 Mbit/s 0100 _B LINK1000 On when Link is 1000 Mbit/s 1000 _B LINK2500 On when Link is 2500 Mbit/s
BLINKF	3:0	RW	Fast Blinking Configuration The Blink-F Field selects in which PHY states the LED blinks with the pre-defined fast frequency. Each bit mask indicates a link speed. Combinations of the bit mask below can be used to provide combination of link speed states to enable the behavior. 0000 _B NONE Not Active 0001 _B LINK10 Blink when Link is 10 Mbit/s 0010 _B LINK100 Blink when Link is 100 Mbit/s 0100 _B LINK1000 Blink when Link is 1000 Mbit/s 1000 _B LINK2500 Blink when Link is 2500 Mbit/s

Chip Level SGMII control register (Register 30.8)

SGMII control register to set up SGMII modes.

IEEE Standard Register=30.8

VSPEC1_SGMII_CTRL

Reset Value

Chip Level SGMII control register (Register 30.8)

34DA_H

															15	14	13	12	11	10	9	8	7	6	5	4			2	1	0
	RST	LB	Res	ANEN	PD	RXINV	Res	EEE_CAP	Res	SGMII_F*	Res						ANMODE														
	rw	rw		rw	rw	rw		rw		rw							rw														

Field	Bits	Type	Description
RST	15	RW	Reset SGMII SGMII reset 0 _B NORM Normal Operation SGMII 1 _B RST Reset SGMII
LB	14	RW	Loopback SGMII loopback 0 _B OFF SGMII Loopback is disabled 1 _B ON SGMII Loopback Enabled
ANEN	12	RW	ANEG Enable If bit 12 is set to a logic one, ANMODE field determines the Auto-Negotiation protocol. If bit 12 is cleared to a logic zero, speed is set to maximum in full duplex mode. Once the TPI link is up, the SGMII speed is automatically forced to match the TPI speed. This bit has no effect when SGMII_FIXED2G5 is '1'. 0 _B OFF SGMII ANEG DisabledSpeed is set to maximum in full duplex mode until TPI is linkup. 1 _B ON SGMII ANEG EnabledThe negotiation style is configured by the field ANMODE
PD	11	RW	Power Down SGMII Power Down 0 _B OFF Normal Operation SGMII 1 _B ON SGMII Power Down. In this state, other bits on VSPEC1_SGMII_CTRL register has no effect.
RXINV	10	RW	Inversion of RX0_M and RX0_P The purpose of inverting RxM and RxP is to simplify PCB layout (not crossing of lanes, allows 1 layer) 0 _B NORMAL No Inversion Pin 28 is RX0_P, pin 27 is RX0_M 1 _B INVERT Invert RX SGMII Pin 28 is RX0_M, pin 27 is RX0_P
EEE_CAP	7	RW	EEE SGMII ANEG EEE SGMII Capability is advertised in ANEG Used only when ANMODE = AN_CIS_PHY 0 _B OFF EEE is not advertised 1 _B ON EEE is advertised
ANMODE	1:0	rw	SGMII ANEG Mode Defines the type of ANEG protocol when ANEG is enabled 00 _B RES ReservedDo not use, will default to AN_CIS_PHY 01 _B AN_1000BX IEEE 1000Bx SGMII ANEGClause 37 SGMII 1000Bx ANEG is used 10 _B AN_CIS_PHY CISCO SGMII ANEG mode with GPY acting as a PHYANEG is done as defined by CISCO SGMII standard, as a PHY-side SGMII.This is the default configuration. 11 _B AN_CIS_MAC CISCO SGMII ANEG mode with GPY acting as a MACANEG is done as defined by CISCO SGMII standard, as a MAC-side SGMII.

NBASE-T Downshift Control Register (Register 30.10)

IEEE Standard Register=30.10

VSPEC1_NBT_DS_CTRL

Reset Value

NBASE-T Downshift Control Register (Register 30.10)

0400_H

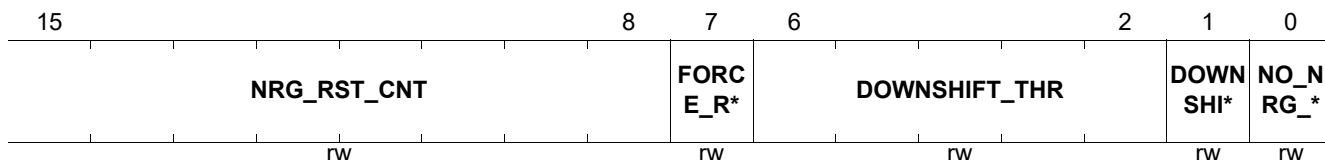

Field	Bits	Type	Description
NRG_RST_CNT	15:8	RW	Timer to Reset the Downshift process If energy is zero for a duration equal to NRG_RST_CNT seconds approximately, then resets the ANEG advertised capabilities to the maximum GPY capabilities. Default is 4 seconds
FORCE_RST	7	RW	Force Reset of Downshift Process Setting this bit to 1 immediately resets the ANEG advertised capabilities to the maximum GPY capabilities.
DOWNSHIFT_THR	6:2	RW	NBASE-T Downshift Training Counter Threshold dsh_thr variable in NBASE-T specification Counter from 0 to 15 implemented on 4 bits controlling the number of training cycles allowed for linkup, otherwise downshift
DOWNSHIFT_EN	1	RW	NBASE-T Downshift Enable dsh_en variable in NBASE-T specification 0 _B DISABLE Disable NBT downshift 1 _B ENABLE Enable NBT downshift
NO_NRG_RST	0	RW	Advertise all Speeds if No Energy Detected If no energy is detected, resets to advertise all speeds energy variable in NBASE-T specification 0 _B DISABLE Do not reset speeds adv when no energy detected 1 _B ENABLE Reset speed adv when no energy detected

NBASE-T Downshift Status Register (Register 30.11)

IEEE Standard Register=30.11

VSPEC1_NBT_DS_STA

Reset Value

NBASE-T Downshift Status Register (Register 30.11)

0000_H

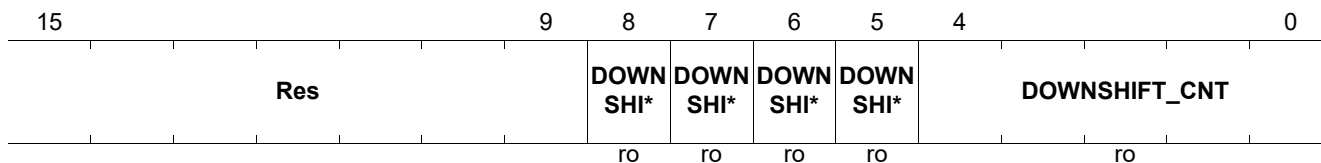

Field	Bits	Type	Description
DOWNSHIFT_1G	8	RO	Downshift from 1G to lower speed
DOWNSHIFT_2G5	7	RO	Downshift from 2.5 G to lower speed Not supported by GPY
DOWNSHIFT_5G	6	RO	Downshift 5G to lower speed Not supported by GPY
DOWNSHIFT_10G	5	RO	Downshift 10G to lower speed Not supported by GPY
DOWNSHIFT_CNT	4:0	RO	Training attempt counter Counts training attempts to select the operating speed dsh_cnt state variable in NBASE-T specification

Packet Manager Control (Register 30.12)

IEEE Standard Register=30.12

Control the Packet Manager Configuration

VSPEC1_PM_CTRL

Reset Value

Packet Manager Control (Register 30.12)

0003_H

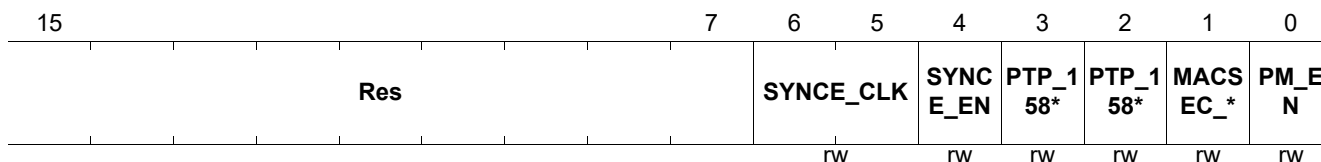

Field	Bits	Type	Description
SYNCE_CLK	6:5	RW	Configure the Sync E clock frequency class. 00 _B PSTN Sync E clock frequency is PSTN class: 8 kHz 01 _B EEC1 Sync E clock frequency is EEC-1 class: 2.048 MHz 10 _B EEC2 Sync E clock frequency is EEC-2 class: 1.544 MHz 11 _B RES Reserved
SYNCE_EN	4	RW	Enable Sync E feature 0 _B DISABLE Disable Sync E 1 _B ENABLE Enable Sync E
PTP_1588_ST EP	3	RW	Configure 1588 time stamping mode 0 _B TWO_STEP Two steps time stamping 1 _B ONE_STEP One step time stamping

Field	Bits	Type	Description (cont'd)
PTP_1588_EN	2	rw	Enable Sync 1588 PTP feature 0 _B DISABLE Disable 1 _B ENABLE Enable
MACSEC_EN	1	RW	Disable MACsec (Applicable to MACsec capable devices only) On MACsec capable products, the MACsec feature is enabled at power up. This option allows to disable MACsec feature programmatically. On non-MACsec capable products, this option has no effect and is always DISABLE. The MACsec capability is indicated a power up in VSPEC1_SGMII_STAT.MACSEC_CAP. 0 _B DISABLE Disable 1 _B ENABLE Enable no effect on GPY
PM_EN	0	RW	Enable Packet Manager Enable LPI generation within the GPY Packet Manager on GPY supports the Smart AZ and PTP features. 0 _B DISABLE Disable PM is bypassed 1 _B ENABLE Enable

Temperature code (Register 30.14)

Junction Temperature Code that can be converted to T Celsius by the GPY API.

IEEE Standard Register=30.14

VSPEC1_TEMP_STA

Reset Value

Temperature code (Register 30.14)

0000_H

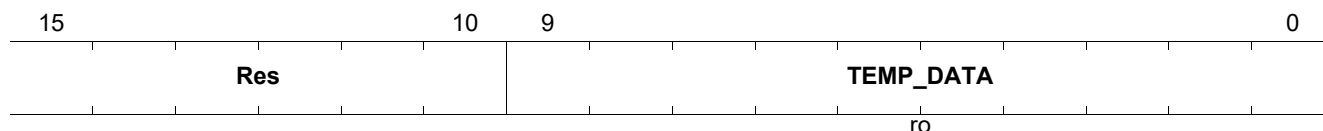

Field	Bits	Type	Description
TEMP_DATA	9:0	RO	<p>Code for Junction Temperature</p> <p>This code can be converted to Temperature in Celsius Degrees by the GPY API driver. The STA is expected to take thermal mitigation measures when the junction temperature exceeds Normal Operating Range. The code is invalid when the value is 0x0000.</p> <p>Conversion formula: T in Celsius = (-2.5761E-11)*N^4 + (9.7332E-8)*N^3+ (-1.9165E-04)*N^2+(3.0762E-1)*N +(-5.2156E+1) , with N = decimal value of the code TEMP_DATA</p> <p>For Tj = -40 deg C, TEMP_DATA = 40.5 (decimal)</p> <p>For Tj= +125 degC, TEMP_DATA = 912 (decimal)</p>

MACSec Interrupt Mask Register (Register 30.17)

This register defines the mask for the Interrupt Status Register (ISTAT) which contains the event source for the MDINT interrupt sent from GPY to an external chip.

The information about the interrupt source is indicated in the VSPEC1_ISTAT register.

IEEE Standard Register=30.17

VSPEC1_IMASK

Reset Value

MACSec Interrupt Mask Register (Register 30.17)

0000_H

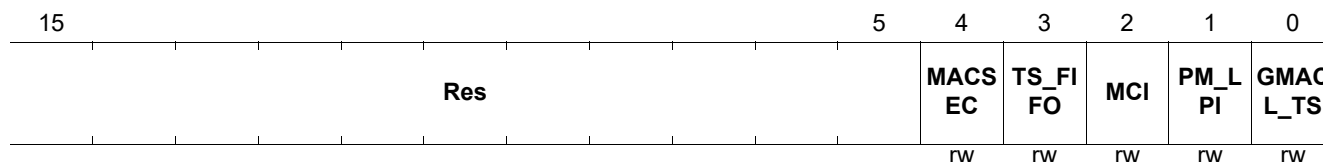

Field	Bits	Type	Description
MACSEC	4	RW	<p>MACSEC Egress/Ingress Interrupt</p> <p>When active, MDINT is activated upon interrupt from MACSEC Egress/Ingress.</p> <p>0_B INACTIVE Interrupt is masked out</p> <p>1_B ACTIVE Interrupt is activated</p>

Field	Bits	Type	Description (cont'd)
TS_FIFO	3	RW	Time Stamp FIFO Interrupt When active, MDINT is activated upon interrupt from either TX or RX Time Stamp FIFO. 0 _B INACTIVE Interrupt is masked out 1 _B ACTIVE Interrupt is activated
MCI	2	RW	MCI Interrupt Request When active, MDINT is activated upon interrupt request from MCI. 0 _B INACTIVE Interrupt is masked out 1 _B ACTIVE Interrupt is activated
PM_LPI	1	RW	PM LPI Interrupt Request When active, MDINT is activated upon LPI Interrupt Request from PM. 0 _B INACTIVE Interrupt is masked out 1 _B ACTIVE Interrupt is activated
GMACL_TS	0	RW	Status of Interrupt Request GMACL TS When active, MDINT is activated upon GMACL Timestamp Valid Interrupt 0 _B INACTIVE Interrupt is masked out 1 _B ACTIVE Interrupt is activated

MACSec Interrupt Mask Register (Register 30.18)

This register defines the event source for the MDINT interrupt sent from GPY to an external chip based on the mask settings in VSPEC1_IMASK register.

VSPEC1_ISTAT is a cleared on read by the STA.

IEEE Standard Register=30.18

VSPEC1_ISTAT

Reset Value

MACSec Interrupt Mask Register (Register 30.18)

0000_H

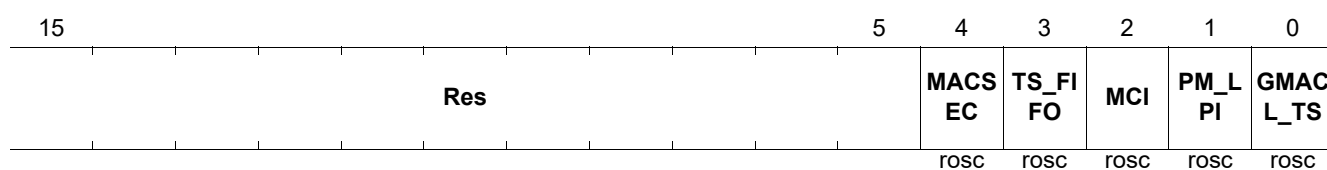

Field	Bits	Type	Description
MACSEC	4	ROSC	MACSEC Egress/Ingress Interrupt When bit is set, MDINT is activated upon interrupt from MACSEC Egress/Ingress. 0 _B INACTIVE This event is not the interrupt source 1 _B ACTIVE MACSEC Egress/Ingress Interrupt is the source of Interrupt
TS_FIFO	3	ROSC	Time Stamp FIFO Interrupt When bit is set, MDINT is activated upon interrupt from either TX or RX Time Stamp FIFO. 0 _B INACTIVE This event is not the interrupt source 1 _B ACTIVE Time Stamp FIFO Interrupt is the source of Interrupt

Field	Bits	Type	Description (cont'd)
MCI	2	ROSC	MCI Interrupt Request When bit is set, MDINT is activated upon interrupt request from MCI. 0 _B INACTIVE This event is not the interrupt source 1 _B ACTIVE MCI Interrupt Request is the source of Interrupt
PM_LPI	1	ROSC	PM LPI Interrupt Request When bit is set, MDINT is activated upon LPI Interrupt Request from PM. 0 _B INACTIVE This event is not the interrupt source 1 _B ACTIVE LPI Interrupt Request from PM is the source of Interrupt
GMACL_TS	0	ROSC	Status of Interrupt Request GMACL TS When bit is set, MDINT is activated upon interrupt from GMACL Timestamp Valid Interrupt. 0 _B INACTIVE This event is not the interrupt source 1 _B ACTIVE GMACL Time Stamp is the source of Interrupt

ASP Mapping to Physical Lanes(Register 30.20)

Programmable option to map physical lanes A,B,C,D of the TPI to the ASPs.

Note: Each ASP must be mapped to each lane.

IEEE Standard Register=30.20

VSPEC1_LANE_ASP_MAP

Reset Value

ASP Mapping to Physical Lanes(Register 30.20)

00E4_H

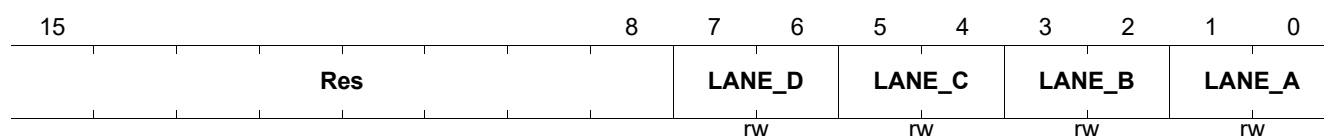

Field	Bits	Type	Description
LANE_D	7:6	RW	Map Physical Lane-D to the ASP 00 _B ASPA Map Physical Lane-D to the ASP-A 01 _B ASPB Map Physical Lane-D to the ASP-B 10 _B ASPC Map Physical Lane-D to the ASP-C 11 _B ASPD Map Physical Lane-D to the ASP-D
LANE_C	5:4	RW	Map Physical Lane-C to the ASP 00 _B ASPA Map Physical Lane-C to the ASP-A 01 _B ASPB Map Physical Lane-C to the ASP-B 10 _B ASPC Map Physical Lane-C to the ASP-C 11 _B ASPD Map Physical Lane-C to the ASP-D
LANE_B	3:2	RW	Map Physical Lane-B to the ASP 00 _B ASPA Map Physical Lane-B to the ASP-A 01 _B ASPB Map Physical Lane-B to the ASP-B 10 _B ASPC Map Physical Lane-B to the ASP-C 11 _B ASPD Map Physical Lane-B to the ASP-D

Field	Bits	Type	Description (cont'd)
LANE_A	1:0	RW	Map Physical Lane-A to the ASP 00 _B ASPA Map Physical Lane-A to the ASP-A 01 _B ASPB Map Physical Lane-A to the ASP-B 10 _B ASPC Map Physical Lane-A to the ASP-C 11 _B ASPD Map Physical Lane-A to the ASP-D

6.5 Vendor Specific 2 Device for MMD=0x1F

This register file contains GPY specific register for MMD=31 (decimal)

Table 25 Registers Overview

Register Short Name	Register Long Name	Reset Value
VPSPEC2_WOL_CTL	Wake-on-LAN Control Register (Register 31.3590)	0000 _H
VPSPEC2_WOL_AD01	Wake-On-LAN Address Byte 0 and 1 (Register 31.3592)	0000 _H
VPSPEC2_WOL_AD23	Wake-on-LAN Address Byte 2 and 3 (Register 31.3593)	0000 _H
VPSPEC2_WOL_AD45	Wake-On-LAN Address Byte 4 and 5 (Register 31.3594)	0000 _H
VPSPEC2_WOL_PW01	Wake-On-LAN SecureON Password Byte 0 (Register 31.3595)	0000 _H
VPSPEC2_WOL_PW23	Wake-on-LAN SecureON Password Byte 2 and 3 (Register 31.3596)	0000 _H
VPSPEC2_WOL_PW45	Wake-on-LAN SecureON Password Byte 4 and 5 (Register 31.3597)	0000 _H

6.5.1 Vendor Specific 2 Device for MMD=0x1F

This chapter describes all registers of VSPEC2 in detail.

Wake-on-LAN Control Register (Register 31.3590)

Wake-on-LAN Control Register. Redirected to PCS_PDI_WOL_CTL

IEEE Standard Register=31.3590

VPSPEC2_WOL_CTL	Reset Value
Wake-on-LAN Control Register (Register 31.3590)	0000_H
<div style="display: flex; justify-content: space-between; margin-bottom: 5px;"> 15 3 2 1 0 </div> <div style="border: 1px solid black; padding: 5px; display: flex; justify-content: space-between;"> <div style="flex-grow: 1; text-align: center;">Res</div> <div style="border-right: 1px solid black; padding: 0 5px;">SPWD _EN</div> <div style="border-right: 1px solid black; padding: 0 5px;">RES</div> <div style="padding: 0 5px;">EN</div> </div> <div style="display: flex; justify-content: flex-end; margin-top: 5px;"> rw ro rw </div>	

Field	Bits	Type	Description
SPWD_EN	2	RW	Secure-ON Password Enable If enabled, checks for the Secure-ON password after the 16 MAC address repetitions. 0 _B DISABLED Secure-On password check is disabled 1 _B ENABLED Secure-On password check is enabled
RES	1	RO	Reserved Must always be written to zero!
EN	0	RW	Enables the Wake-on-LAN functionality If Wake-on-LAN is enabled, the PHY scans for the configured magic packet and indicates its reception via the register bit ISTAT.WOL, and optionally also via interrupt. 0 _B DISABLED Wake-on-LAN functionality is disabled 1 _B ENABLED Wake-on-LAN functionality is enabled

Wake-On-LAN Address Byte 0 and 1 (Register 31.3592)

Wake-on-LAN Address Byte 0 and 1. Redirected to PCS_PDI_WOL_AD01
IEEE Standard Register=31.3592

VPSPEC2_WOL_AD01

Reset Value

Wake-On-LAN Address Byte 0 and 1 (Register 31.3592)

0000_H

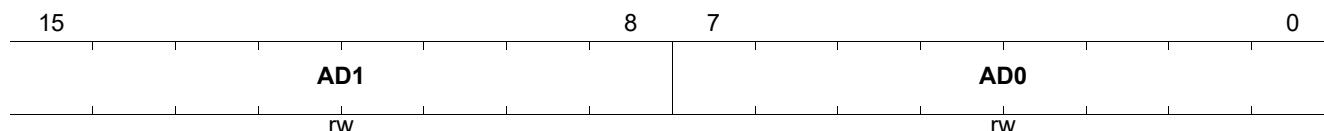

Field	Bits	Type	Description
AD1	15:8	RW	Address Byte 1 Defines byte 1 of the WoL-designated MAC address to which the PHY is sensitive.
AD0	7:0	RW	Address Byte 0 Defines byte 0 of the WoL-designated MAC address to which the PHY is sensitive.

Wake-on-LAN Address Byte 2 and 3 (Register 31.3593)

Wake-On-LAN Address Byte 2 and 3. Redirected to PCS_PDI_WOL_AD23
IEEE Standard Register=31.3593

VPSPEC2_WOL_AD23

Reset Value

Wake-on-LAN Address Byte 2 and 3 (Register 31.3593)

0000_H

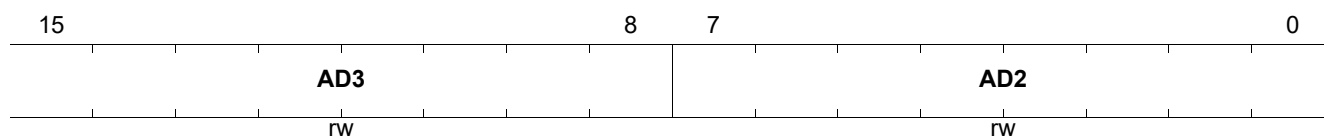

Field	Bits	Type	Description
AD3	15:8	RW	Address Byte 3 Defines byte 3 of the WoL-designated MAC address to which the PHY is sensitive.
AD2	7:0	RW	Address Byte 2 Defines byte 2 of the WoL-designated MAC address to which the PHY is sensitive.

Wake-On-LAN Address Byte 4 and 5 (Register 31.3594)

Wake-On-LAN Address Byte 4 and 5. Redirected to PCS_PDI_WOL_AD45
IEEE Standard Register=31.3594

VPSPEC2_WOL_AD45

Reset Value

Wake-On-LAN Address Byte 4 and 5 (Register 31.3594)

0000_H

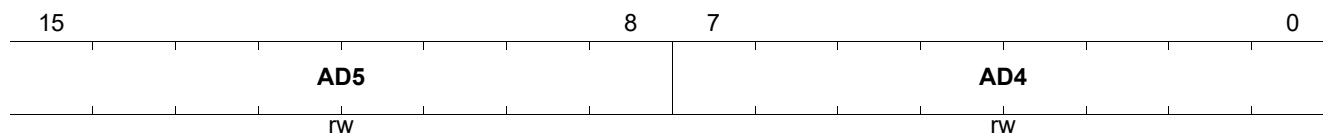

Field	Bits	Type	Description
AD5	15:8	RW	Address Byte 5 Defines byte 5 of the WoL-designated MAC address to which the PHY is sensitive.
AD4	7:0	RW	Address Byte 4 Defines byte 4 of the WoL-designated MAC address to which the PHY is sensitive.

Wake-On-LAN SecureON Password Byte 0 (Register 31.3595)

Wake-on-LAN SecureON Password Byte 0. Redirected to PCS_PDI_WOL_PWD01

IEEE Standard Register=31.3595

VPSPEC2_WOL_PW01

Reset Value

Wake-On-LAN SecureON Password Byte 0 (Register 31.3595)

0000_H

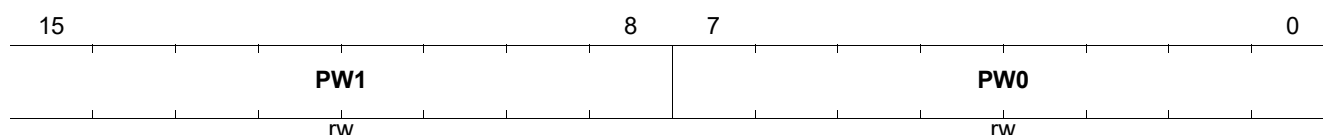

Field	Bits	Type	Description
PW1	15:8	RW	SecureON Password Byte 1 Defines byte 1 of the WoL-designated SecureON password to which the PHY is sensitive.
PW0	7:0	RW	SecureON Password Byte 0 Defines byte 0 of the WoL-designated SecureON password to which the PHY is sensitive.

Wake-on-LAN SecureON Password Byte 2 and 3 (Register 31.3596)

Wake-On-LAN SecureON Password Byte 2 and 3. Redirected to PCS_PDI_WOL_PWD23

IEEE Standard Register=31.3596

VPSPEC2_WOL_PW23

Reset Value

Wake-on-LAN SecureON Password Byte 2 and 3 (Register 31.3596)

0000_H

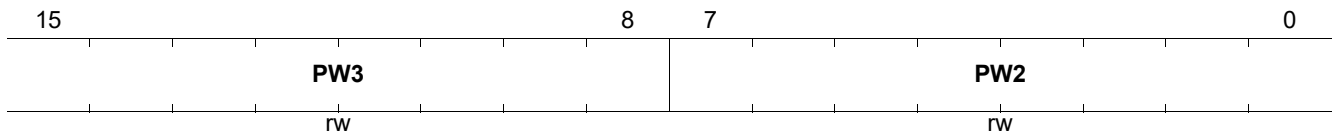

Field	Bits	Type	Description
PW3	15:8	RW	SecureON Password Byte 3 Defines byte 3 of the WoL-designated SecureON password to which the PHY is sensitive.
PW2	7:0	RW	SecureON Password Byte 2 Defines byte 2 of the WoL-designated SecureON password to which the PHY is sensitive.

Wake-on-LAN SecureON Password Byte 4 and 5 (Register 31.3597)

Wake-on-LAN SecureON Password Byte 4 and 5. Redirected to PCS_PDI_WOL_PWD45

IEEE Standard Register=31.3597

VPSPEC2_WOL_PW45

Reset Value

Wake-on-LAN SecureON Password Byte 4 and 5 (Register 31.3597)

0000_H

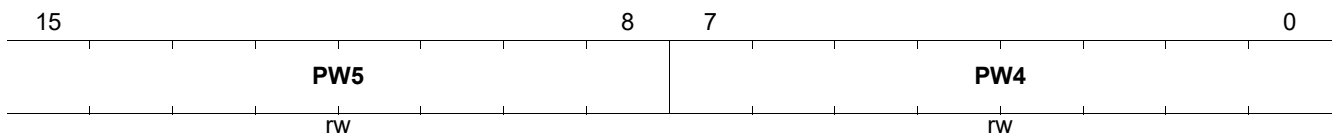

Field	Bits	Type	Description
PW5	15:8	RW	SecureON Password Byte 5 Defines byte 5 of the WoL-designated SecureON password to which the PHY is sensitive.
PW4	7:0	RW	SecureON Password Byte 4 Defines byte 4 of the WoL-designated SecureON password to which the PHY is sensitive.

7 Electrical Characteristics

This chapter defines the electrical characteristics of the Gigabit Ethernet PHY.

Note: This chapter is a preliminary draft and subject to change until PRQ.

7.1 Absolute Maximum Ratings

Table 26 shows the absolute maximum ratings for the Gigabit Ethernet PHY.

Table 26 Absolute Maximum Ratings

Parameter	Symbol	Values			Unit	Note / Test Condition
		Min.	Typ.	Max.		
Storage Temperature Limits	T_{STG}	-55.0	–	125.0	°C	–
Soldering Temperature	T_{SOL}	–	–	260.0	°C	Compliance with Pb free re-flow soldering profile as J-STD-020D
Moisture Level 3 Temperature Limits	T_{ML3}	–	–	260.0	°C	According to IPS J-STD 020
Absolute Junction Temperature	T_{JABS}	0	–	125	°C	Thermal solution must ensure that T_J never exceeds T_{JABS} . The chip resets the device when $T_J > T_{JABS}$ to prevent any damage to occur.
DC Voltage Limits on VDDP3V3 Pins	V_{DDP3V3}	-0.5	–	+3.63	V	V_{HIGH} supply
DC Voltage Limits on VDDP Pins when pin 19 pin strap PS_MDIO_VOLTAGE is HIGH	V_{DDP}	-0.5	–	+3.63	V	V_{HIGH} supply
DC Voltage Limits on VDDP Pins when pin 19 pin strap PS_MDIO_VOLTAGE is LOW	V_{DDP}	-0.5	–	+1.98	V	1.8 V supply dedicated to MDIO pads in lower mode
DC Voltage Limits on VPH Pins	V_{PH}	-0.5	–	+3.63	V	V_{HIGH} supply
DC Voltage Limits on VP Pins	V_P	-0.5	–	+1.05	V	V_{LOW} supply
DC Voltage Limits on VDDA3V3 Pins	V_{DDA3V3}	-0.5	–	+3.63	V	V_{HIGH} supply
DC Voltage Limits on VDDA3V3XO, VDDA3V3CDB, VDDA3V3AON Pins	$V_{DDA3V3XO}$ $V_{DDA3V3CDB}$ $V_{DDA3V3AON}$	-0.5	–	+3.63	V	V_{HIGH} supply
DC Voltage Limits on VDDA0V9 Pins	V_{DDA0V9}	-0.5	–	+1.05	V	V_{LOW} supply
DC Voltage Limits on VDD Pins	V_{DD}	-0.5	–	+1.05	V	V_{LOW} supply

Electrical Characteristics

Table 26 Absolute Maximum Ratings (cont'd)

Parameter	Symbol	Values			Unit	Note / Test Condition
		Min.	Typ.	Max.		
DC Voltage Limits on VDD3V3DCDC Pins	$V_{DD3V3DCDC}$	-0.5	–	+3.63	V	V_{HIGH} supply
DC Voltage Limits on any other pins ¹⁾ with respect to the ground	V_{DC}	-0.5	–	$V_{DDP3V3} + 0.5$	V	Unless specified otherwise
ESD HBM Robustness	$V_{ESD,HBM}$	–	–	1000.0	V	According to ANSI/ESDA/JEDEC JS-001-2014
ESD CDM Robustness	$V_{ESD,CDM}$	–	–	250.0	V	According to ANSI/ESDA/JEDEC JS-002-2014

1) This means any pin which is not a supply pin out of one of the domains: V_{DDP} , V_{PH} , V_P , V_{DDA3V3} , $V_{DDA3V3XO}$, $V_{DDA3V3CDB}$, $V_{DDA3V3AON}$, V_{DDA0V9} , V_{DD} , $V_{DD3V3DCDC}$.

Attention: Stresses above the max. values listed here may cause permanent damage to the device. Exposure to absolute maximum rating conditions for extended periods may affect device reliability. Maximum ratings are absolute ratings; exceeding only one of these values may cause irreversible damage to the integrated circuit.

7.2 Operating Range

Table 27 defines the maximum values of voltages and temperature that must be applied to guarantee proper operation of the Gigabit Ethernet PHY. The values are relative to a ground voltage V_{SS} of 0.0 V.

Table 27 Operating Range

Parameter	Symbol	Values			Unit	Note / Test Condition
		Min.	Typ.	Max.		
Ambient Temperature	T_A	-40	–	85	°C	The thermal design must ensure that the maximum junction temperature is not exceeded. The use of a heat sink must be considered.
Junction Temperature	T_j	–	–	110	°C	Thermal solution must ensure that T_j remains within operating range and never exceed maximum absolute ratings.
Pad Supply Voltage for MDIO signals when pin 19 pin strap PS_MDIO_VOLTAGE is LOW	V_{DDP}	1.71	1.8	1.89	V	1.8 V supply dedicated to MDIO pads in lower mode
Pad Supply Voltage for MDIO signals when pin 19 pin strap PS_MDIO_VOLTAGE is HIGH	V_{DDP}	3.135	3.30	3.46	V	V_{HIGH} supply
Pad Supply Voltage for non-MDIO signals	V_{DDP3V3}	3.13	3.30	3.46	V	V_{HIGH} supply
Analog High Supply Voltage	V_{DDA3V3}	3.13	3.30	3.46	V	V_{HIGH} supply
XO High Supply Voltage	$V_{DDA3V3XO}$	3.13	3.30	3.46	V	V_{HIGH} supply
CDB High Supply Voltage	$V_{DDA3V3CDB}$	3.13	3.30	3.46	V	V_{HIGH} supply
AON High Supply Voltage	$V_{DDA3V3AON}$	3.13	3.30	3.46	V	V_{HIGH} supply
SGMII High Supply Voltage	V_{PH}	3.13	3.30	3.46	V	V_{HIGH} supply
Analog Low Supply Voltage	V_{DDA0V9}	0.97	1.00	1.03	V	V_{LOW} supply
SGMII Low Supply Voltage	V_P	0.97	1.00	1.03	V	V_{LOW} supply
Core Digital Supply Voltage	V_{DD}	0.97	1.00	1.03	V	V_{LOW} supply
DCDC Supply Voltage	$V_{DD3V3DCDC}$	3.13	3.30	3.46	V	V_{HIGH} supply
Digital Input Voltage	V_{ID}	-0.30	–	$V_{DDP3V3}+0.3$	V	–
XTAL1 Input Voltage	V_{XTLA1}	-0.30	1.8	2	V	–

Attention: Operations above the max. values listed here for extended periods can adversely affect long-term reliability of the device.

7.3 Chip Power Consumption

Power consumption at 25°C ambient temperature is indicated in [Table 28](#) and [Table 29](#) for the different modes 1000/100/10BASE-T in Link-up and EEE modes. The Link-up conditions are full-speed, bidirectional, full-duplex.

Power numbers are indicated for the 2 supply configuration:

- using an external supply of the V_{LOW} domains at 1.0 V (circuitry specified in [Figure 29](#))
- using the internal DCDC SVR (circuitry specified in [Figure 28](#))

Table 28 Typical Power Consumption (GPY115C0VI)

Conditions: 25°C, CAT 5E Cable V_{LOW} at 1.0 V	3.3 V V_{HIGH} Domain Current, with external Supply of V_{LOW}	1.0 V V_{LOW} Domain Current, with external Supply of V_{LOW}	Chip Power with external Supply of V_{LOW}	Chip Power with Supply of V_{LOW} generated by internal DC/DC SVR
Unit	mA	mA	W	W
1000BASE-T Link-Up, 100 m cable	74	275	0.52	0.58
1000BASE-T EEE	30	140	0.24	0.24
100BASE-TX Link-Up, 100 m cable	42	121	0.26	0.24
100BASE-TX EEE	30	112	0.21	0.17
10BASE-Te Link-Up, 100 m cable	33	101	0.21	0.18
Cable Unplugged - ANEG	33	103	0.22	0.23
Cable Unplugged - ULP	NA ¹⁾	NA ¹⁾	NA ¹⁾	0.005
Reset	8.6	19	0.045	0.015

1) The ULP state is reachable only when an internal DCDC SVR supply mode is used. In such cases, 1.6 mA is consumed by the 3.3 V V_{high} domain. When the External DCDC SVR supply mode is used, the lowest power state is ANEG.

Table 29 Typical Power Consumption (GPY115B1VI)

Conditions: 25°C, CAT 5E Cable V_{LOW} at 1.0 V	3.3 V V_{HIGH} Domain Current, with external Supply of V_{LOW}	1.0 V V_{LOW} Domain Current, with external Supply of V_{LOW}	Chip Power with external Supply of V_{LOW}	Chip Power with Supply of V_{LOW} generated by internal DC/DC SVR
Unit	mA	mA	W	W
1000BASE-T Link-Up, 100 m cable	98	322	0.63	0.62
1000BASE-T EEE	43	187	0.32	0.31
100BASE-TX Link-Up, 100 m cable	57	132	0.31	0.28
100BASE-TX EEE	38	122	0.24	0.21
10BASE-Te Link-Up, 100 m cable	45	114	0.25	0.23
Cable Unplugged - ANEG	39	134	0.26	0.23
Cable Unplugged - ULP	NA ¹⁾	NA ¹⁾	NA ¹⁾	0.005
Reset	8.6	19	0.045	0.015

Electrical Characteristics

- 1) The ULP state is reachable only when an internal DCDC SVR supply mode is used. In such cases, 1.6 mA is consumed by the 3.3 V V_{high} domain. When the External DCDC SVR supply mode is used, the lowest power state is ANEG.

Table 30 Maximum Power Consumption (GPY115C0VI)

Conditions: T_j 110°C	External Supply of V_{Low}	V_{Low} Generated by Internal DC/DC SVR
Unit	mW	mW
Maximum Chip Power at maximum operating range	750	720

Table 31 Maximum Power Consumption (GPY115B1VI)

Conditions: T_j 110°C	External Supply of V_{Low}	V_{Low} Generated by Internal DC/DC SVR
Unit	mW	mW
Maximum Chip Power at maximum operating range	798	734

Note: Analysis indicates that real application are unlikely to cause T_j to exceed 110°C, given a properly designed thermal solution: Heat Sink and change of speed controlled by the STA when the temperature T_j (reported in MDIO register VSPEC1_TMP_STA) exceeds the operating range.

7.4 DC Characteristics

The following sections describe the DC characteristics of the Gigabit Ethernet PHY external interfaces.

7.4.1 Digital Interfaces

This chapter defines the DC characteristics of the GPIO interfaces as follows:

- MDIO
- Interrupts
- Clock Outputs
- General Purpose IO
- LED
- JTAG
- SPI

The DC characteristics for $V_{DDP}=3.3$ V are summarized in [Table 32](#).

Table 32 DC Characteristics of the GPIO Interfaces (VDDP = 3.3 V)

Parameter	Symbol	Values			Unit	Note / Test Condition
		Min.	Typ.	Max.		
Input High Voltage	V_{IH}	2	–	$V_{DDP}+0.3$	V	–
Input Low Voltage	V_{IL}	–0.3	–	0.8	V	–
Output High Voltage	V_{OH}	$V_{DDP}-0.4$	–	–	V	$I_{OH}= 2, 4, 8, 12$ mA
Output Low Voltage	V_{OL}	–	–	0.4	V	$I_{OL}= 2, 4, 8, 12$ mA

The DC characteristics for $V_{DDP}=1.8$ V are summarized in [Table 33](#).

Table 33 DC Characteristics of the GPIO Interfaces (VDDP = 1.8 V)

Parameter	Symbol	Values			Unit	Note / Test Condition
		Min.	Typ.	Max.		
Input High Voltage	V_{IH}	$0.65 \cdot V_{DDP}$	–	$V_{DDP}+0.3$	V	–
Input Low Voltage	V_{IL}	–0.3	–	$0.35 \cdot V_{DDP}$	V	–
Output High Voltage	V_{OH}	$V_{DDP}-0.4$	–	–	V	$I_{OH}= 2, 4, 8, 12$ mA
Output Low Voltage	V_{OL}	–	–	0.4	V	$I_{OL}= 2, 4, 8, 12$ mA

7.4.2 Twisted Pair Interface

The TPI conforms to the specifications of 10BASE-T (Clause 14), 100BASE-TX (Clause 25), 1000BASE-T (Clause 40) given in IEEE 802.3-2005, IEEE 802.3bz, as well as ANSI X3.263-1995.

7.4.3 Built-in Temperature Sensor

The following table gives the parameters of the integrated temperature sensor, measuring junction temperature T_j .

Table 34 Temperature Sensor Characteristics

Parameter	Symbol	Values			Unit	Note / Test Condition
		Min.	Typ.	Max.		
Temperature Range	T_{range}	-40		125	°C	Thermal Mitigation measures must ensure that T_j remains within operating range. If T_j exceeds Maximum Ratings, the GPY performs a self-reset to prevent damage, and the next ANEG is re-started advertising a lower speed.
Resolution		–	10	–	bits	–
Accuracy		-5	–	+5	°C	–

7.5 AC Characteristics

The following sections describe the AC characteristics of the external interfaces.

7.5.1 Power Up and Power Down Sequence with External Supply of V_{LOW} Domain

In this configuration, both V_{HIGH} , $V_{DDP}^{1)}$ and V_{LOW} are supplied externally.

The High Voltage domain V_{HIGH} must always be at a higher voltage level, than the Low Voltage Domain V_{LOW} . When PS_MDIO_VOLTAGE is LOW then V_{DDP} will be at 1.8 V. In such scenario V_{HIGH} must always be at a higher voltage than V_{DDP} and V_{DDP} must always be at a higher voltage than the Low Voltage Domain V_{LOW} .

V_{HIGH} , $V_{DDP}^{1)}$ and V_{LOW} ramp-up times (t_{vh_rampup} , $t_{vddp_rampup}^{1)}$ and t_{vl_rampup}) must be above the minimum requirement.

All the supply domains V_{HIGH} , $V_{DDP}^{1)}$ and V_{LOW} must be stabilized before releasing the reset HRSTN.

During the power-down Sequence, V_{HIGH} ramp down time must not be shorter than the minimum requirement.

The device reset HRSTN must be held for a t_{reset} time after the stabilization of the power supplies and pin strap values. When reset is released, the integrated PLL locks and the device boots up.

The GPY115 supports an asynchronous hardware reset HRSTN. The timing requirements of the power supply pins are listed in [Table 35](#). The timings refer to the signal sequence waveforms depicted in [Figure 17](#) when PS_MDIO_VOLTAGE is HIGH and [Figure 18](#) PS_MDIO_VOLTAGE is LOW.

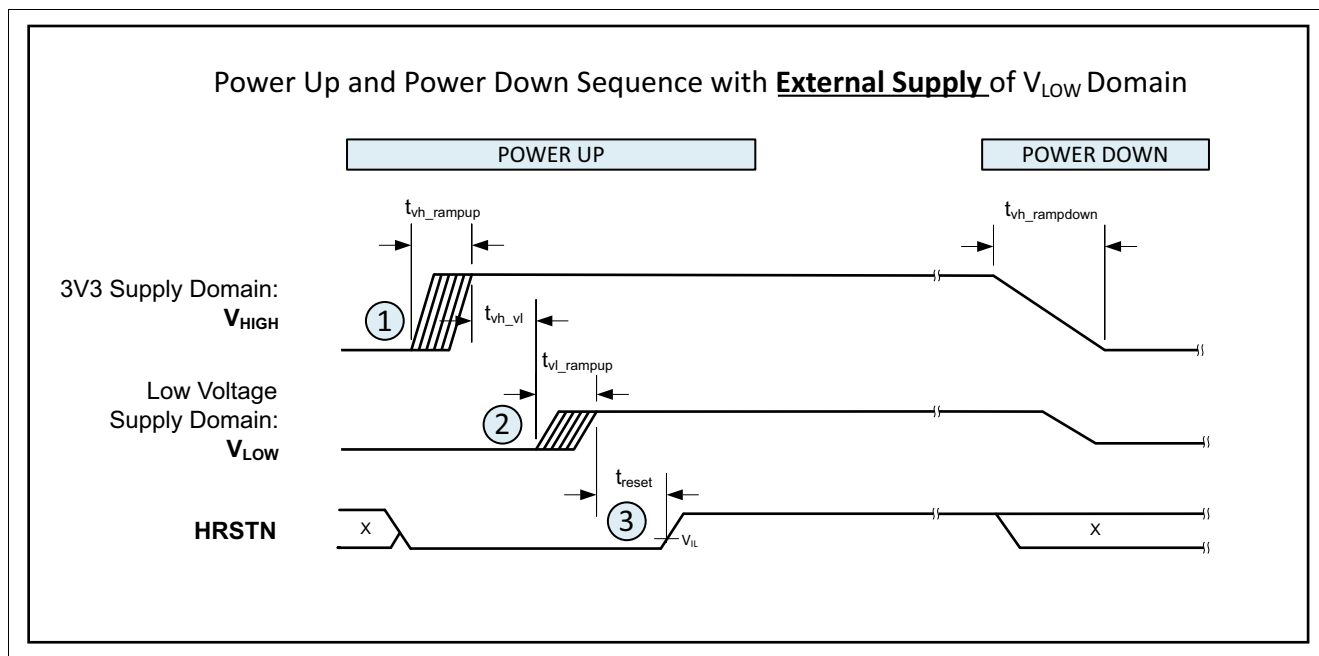

Figure 17 Timing Diagram for the Reset Sequence (External supply of V_{LOW} domain)

1) When PS_MDIO_VOLTAGE is LOW then V_{DDP} will be at 1.8 V and requirements that differentiate V_{DDP} from V_{HIGH} is applicable. When PS_MDIO_VOLTAGE is HIGH then V_{DDP} will be treated as V_{HIGH} .

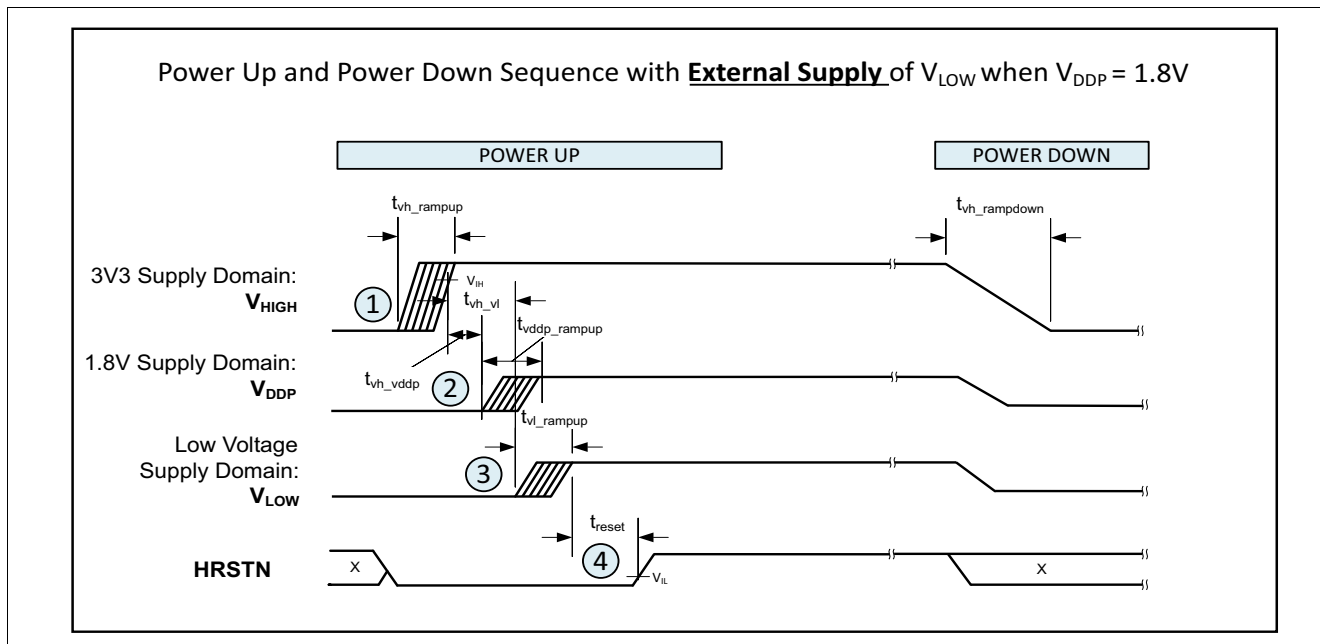

Figure 18 Timing Diagram for the Reset Sequence (External supply of V_{LOW} domain) when $V_{DDP}=1.8\text{ V}$

Table 35 Power Supply Timings (External supply of V_{LOW} domain)

Parameter	Symbol	Values			Unit	Note / Test Condition
		Min.	Typ.	Max.		
V_{HIGH} domain ramp up	t_{vh_rampup}	50	–	–	μs	To avoid current surge.
$V_{DDP}^{1)}$ domain ramp up	t_{vddp_rampup}	50	–	–	μs	To avoid current surge.
V_{LOW} domain ramp up	t_{vl_rampup}	50	–	–	μs	To avoid current surge.
Delay between V_{HIGH} and V_{LOW} domains voltage ramp up	t_{vh_vl}	100	–	–	μs	The V_{LOW} voltage must never be higher than V_{HIGH} voltage
Delay between V_{HIGH} and $V_{DDP}^{1)}$ domains voltage ramp up	t_{vh_vddp}	50	–	–	μs	The V_{DDP} voltage must never be higher than V_{HIGH} voltage.
V_{HIGH} domain ramp down	$t_{vh_rampdown}$	1.0	–	–	ms	The V_{LOW} voltage must never be higher than V_{HIGH} voltage .
Reset time after V_{HIGH} and V_{LOW} domains are stabilized	t_{reset}	100	–	–	ns	HRSTN must be released after the power supplies have stabilized.

Rise and ramp down times are from 10% to 90% marks for V_{HIGH} , V_{LOW} and HRSTN.

7.5.2 Power Up and Power Down Sequence in Internal DCDC SVR Configuration

In internal DCDC SVR configuration, the High Voltage domain V_{HIGH} , $V_{DDP}^{1)}$ and the HRSTN need to be controlled externally. The V_{LOW} domain is supplied by the DCDC_REGO outputs of the internal SVR.

V_{HIGH} , $V_{DDP}^{1)}$ domain ramp-up time t_{vh_rampup} , $t_{vddp_rampup}^{1)}$ must not be too short.

V_{HIGH} domain must be stabilized for t_{reset} time before releasing the reset HRSTN.

When reset is released, the integrated SVR generates the DCDC_REGO which supplies the V_{LOW} domain. Subsequently, integrated PLL locks and the device boots up.

During the power-down sequence, V_{HIGH} ramp down time $t_{vh_rampdown}$ must be higher than the minimum requirement.

The timing requirements of the power supply pins are listed in [Table 36](#). The timings refer to the signal sequence waveforms depicted in [Figure 19](#) when PS_MDIO_VOLTAGE is HIGH and [Figure 20](#) PS_MDIO_VOLTAGE is LOW.

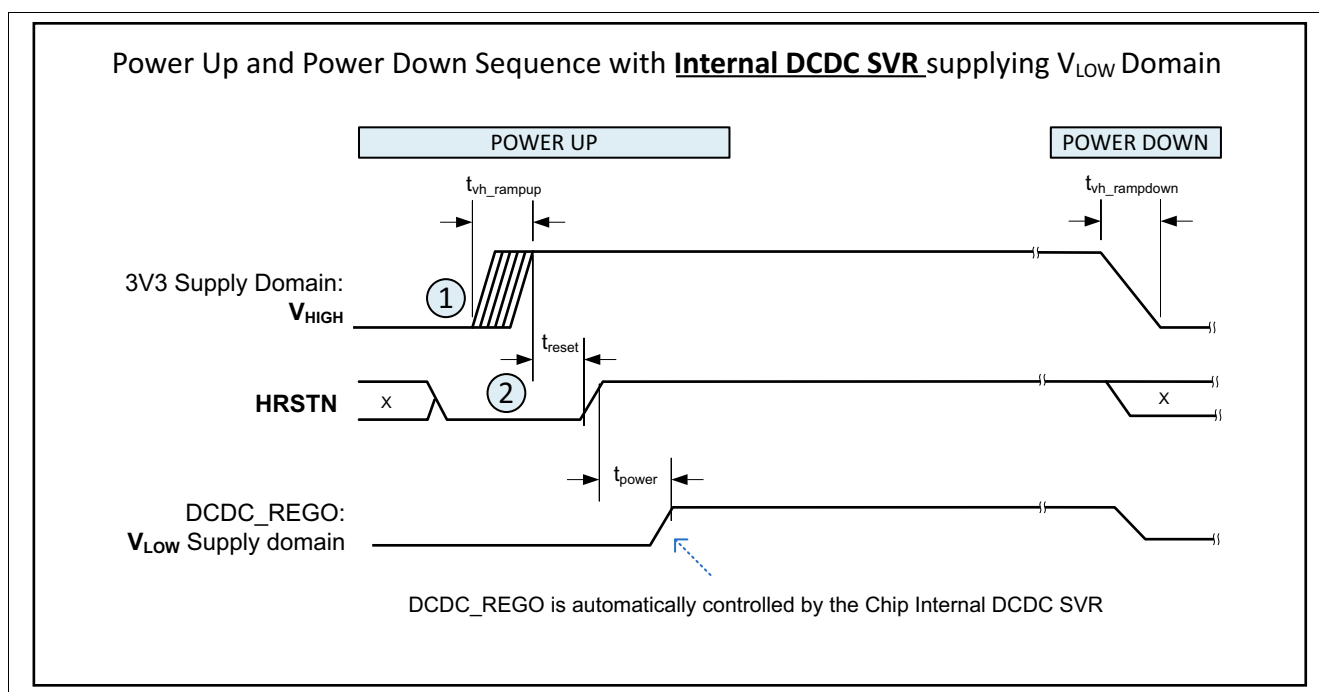

Figure 19 Timing Diagram for the Reset Sequence (Internal DCDC SVR Configuration)

1) When PS_MDIO_VOLTAGE is LOW then V_{DDP} will be at 1.8 V and requirements that differentiate V_{DDP} from V_{HIGH} is applicable. When PS_MDIO_VOLTAGE is HIGH then V_{DDP} will be treated as V_{HIGH} .

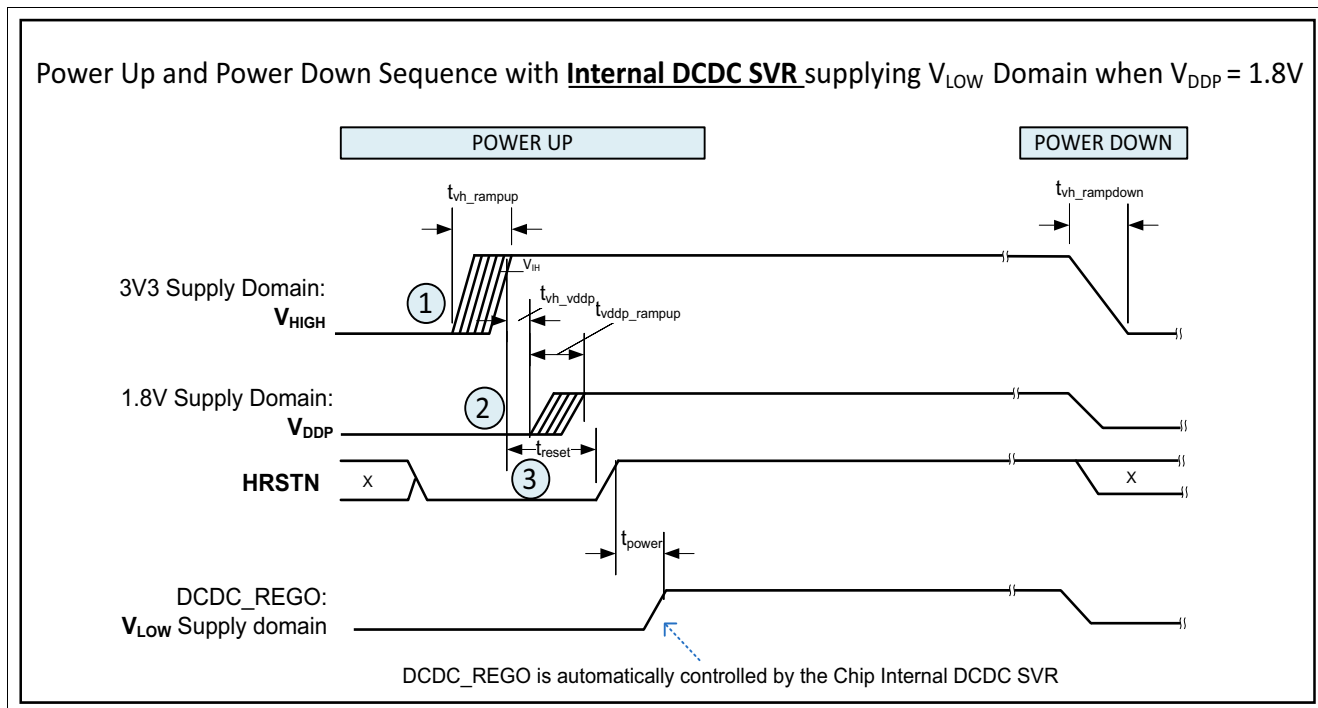

Figure 20 Timing Diagram for the Reset Sequence (Internal DCDC SVR Configuration) when $V_{DDP}=1.8\text{ V}$

Table 36 Power Supply Timings (Internal DCDC SVR Configuration)

Parameter	Symbol	Values			Unit	Note / Test Condition
		Min.	Typ.	Max.		
V_{HIGH} domain ramp up	t_{vh_rampup}	50.0	–	–	μs	To avoid current surge.
V_{HIGH} domain ramp down	$t_{vh_rampdown}$	1.0	–	–	ms	-
$V_{DDP}^{(1)}$ domain ramp up	t_{vddp_rampup}	50	–	–	μs	To avoid current surge.
Delay between V_{HIGH} and $V_{DDP}^{(1)}$ domains voltage ramp up	t_{vh_vddp}	50	-	-	μs	The V_{DDP} voltage must never be higher than V_{HIGH} voltage.
Reset Time	t_{reset}	500	–	–	μs	HRSTN must be released after stabilization of V_{HIGH} domain.
DCDC_REGO ramp up (indication)	t_{power}	–	2	5.0	ms	Indicative of the maximum time for the internal DC/DC converter to stabilize DCDC_REGO low voltage after HRSTN is released. This is internally controlled by the chip, thus it is not an external system requirement.

Rise and ramp down times are from 10% to 90% marks for V_{HIGH} , V_{LOW} and HRSTN.

7.5.3 Power Supply Rail Requirements

Table 37 lists the required characteristics of the power supplies.

Table 37 AC Characteristics of the Power Supply

Parameter	Symbol	Values			Unit	Note / Test Condition
		Min.	Typ.	Max.		
Power Supply Ripple on VDDA0V9	$R_{VDDA0V9}$	–	–	60.0	mV	Peak to Peak value
Power Supply Ripple on VP	R_{VP}	–	–	60.0	mV	Peak to Peak value
Power Supply Ripple on VDD	R_{VDD}	–	–	60.0	mV	Peak to Peak value
Power Supply Ripple on VDDP	R_{VDDP}	–	–	100.0	mV	Peak to Peak value
Power Supply Ripple on VDDA3V3	$R_{VDDA3V3}$	–	–	100.0	mV	Peak to Peak value
Power Supply Ripple on VDDA3V3XO	$R_{VDDA3V3XO}$	–	–	100.0	mV	Peak to Peak value
Power Supply Ripple on VDDA3V3CDB	$R_{VDDA3V3CDB}$	–	–	100.0	mV	Peak to Peak value
Power Supply Ripple on VDDA3V3AON	$R_{VDDA3V3AON}$	–	–	100.0	mV	Peak to Peak value
Power Supply Ripple on VPH	R_{VPH}	–	–	100.0	mV	Peak to Peak value
Power Supply Ripple on VDD3V3DCDC	$R_{VDD3V3DCDC}$	–	–	100.0	mV	Peak to Peak value

7.5.4 MDIO Interface

Figure 21 shows a timing diagram of the slave MDIO interface for a clock cycle in the read, write and turnaround modus. The timing measurements are annotated. The defined absolute values are summarized in Table 38.

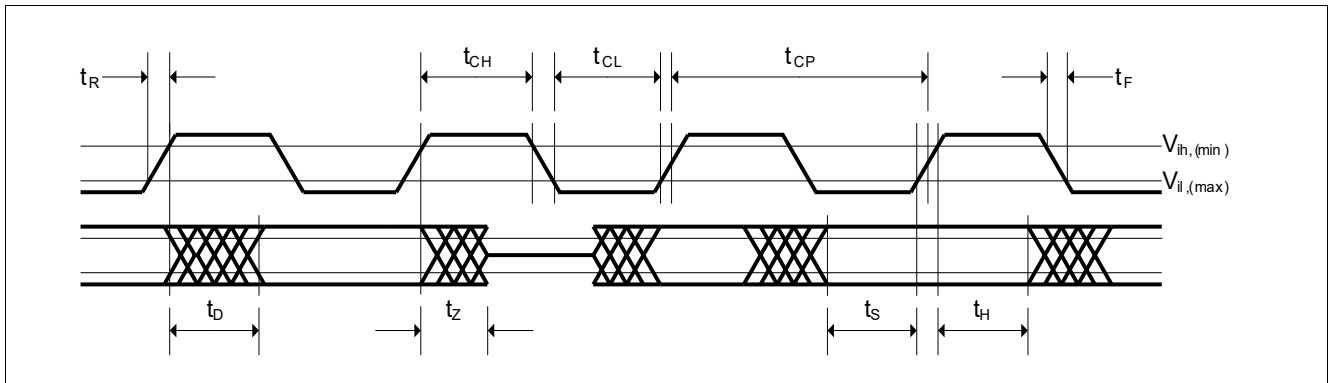

Figure 21 Timing Diagram for the MDIO Interface

Table 38 Timing Characteristics of the MDIO Interface

Parameter	Symbol	Values			Unit	Note / Test Condition
		Min.	Typ.	Max.		
MDC High Time	t_{CH}	10.0	–	–	ns	Given timings all refer to the MDC signal probed at the pin of the Gigabit Ethernet PHY.
MDC Low Time	t_{CL}	10.0	–	–	ns	
MDC Clock Period	t_{CP}	40.0	400.0	–	ns	
MDC Clock Frequency ¹⁾	t_{CP}	–	2.5	25.0	MHz	
MDC Rise Time	t_R	–	–	5.0	ns	
MDC Fall Time	t_F	–	–	5.0	ns	
MDIO Input Setup Time	t_S	10.0	–	–	ns	Gigabit Ethernet PHY Receive
MDIO Input Hold Time	t_H	10.0	–	–	ns	Gigabit Ethernet PHY receive
MDIO Output Delay Time	t_D	0.0	–	10	ns	Gigabit Ethernet PHY transmit
Standard @2.5 MHz						
MDIO Output Delay	t_D	0.0	–	300.0	ns	PHY transmit
MDIO Output Setup Time	t_S	10.0	–	–	ns	MAC transmit
MDIO Output Hold Time	t_H	10.0	–	–	ns	MAC transmit

1) MDC clock supports range of frequencies up to 25 MHz. Default/typical frequency is 2.5 MHz.

7.5.5 SGMII Interface

This section describes the AC characteristics of the SGMII Interface on the GPY115.

The SGMII Interface timing characteristics are described below:

- Transmit timing characteristics ([Chapter 7.5.5.1](#))
- Receive timing characteristics ([Chapter 7.5.5.2](#))

7.5.5.1 Transmit Timing Characteristics

[Figure 22](#) shows the timing diagram of the transmit SGMII interface on the GPY115. It is referred to by [Table 39](#), which specifies the timing requirements.

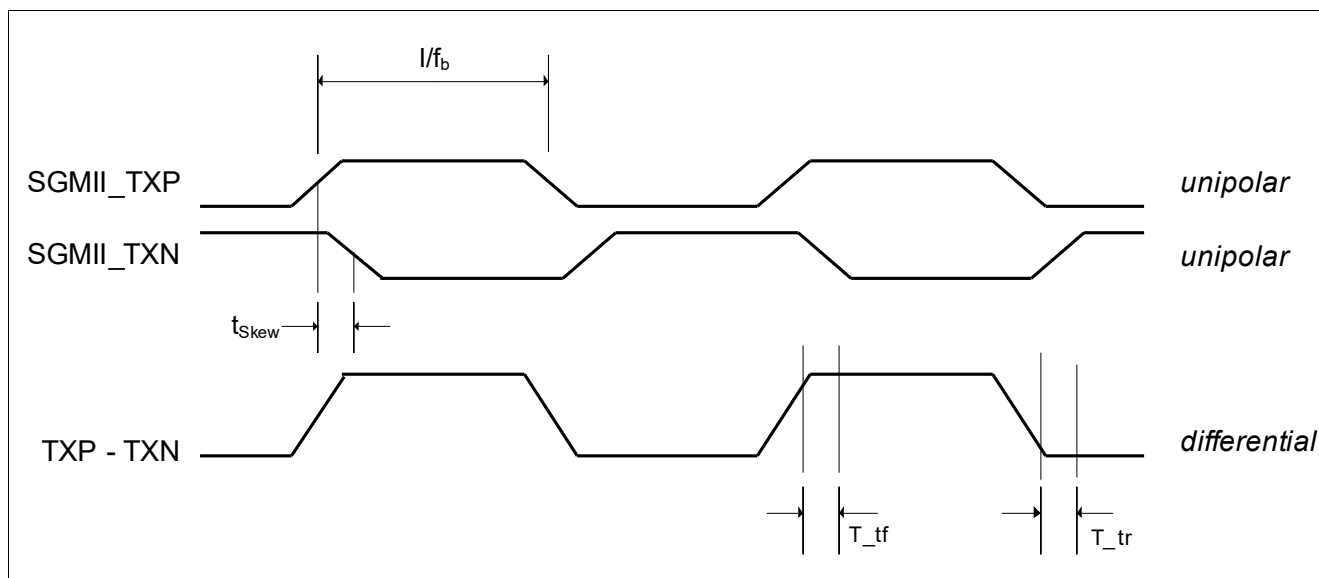

Figure 22 Transmit Timing Diagram of the SGMII (shows alternating data sequence)

Table 39 Transmit Timing Characteristics of the SGMII

Parameter	Symbol	Values			Unit	Note / Test Condition
		Min.	Typ.	Max.		
Transmit baud rate	f_b	-100 ppm	f_b	+100 ppm	Mbaud	$f_b = 1.25$ Gbaud
Differential transmit rise time	T_{tr}	30 ps	–	0.25 UI	–	20%→80% ¹⁾
Differential transmit fall time	T_{tf}	30 ps	–	0.25 UI	–	80%→20%
Output timing jitter	T_{TJ}	–	–	0.30	UI _{pp} ²⁾	
Time skew between pairs	t_{Skew}	–	–	15	ps	–
Output differential voltage	V_{OD}	400	–	1600	mV	Peak-peak amplitude
Output impedance (differential)	R_O	80	100	120	Ω	–

1) UI = $1/f_b$, Unit Interval.

2) Refer to [1] for details. The p-p (peak to peak) measurement states the maximum to minimum amount of time deviation.

7.5.5.2 Receive Timing Characteristics

Figure 23 shows the timing diagram of the receive SGMII interface of the GPY115. Refer to Table 40 for the timing requirements.

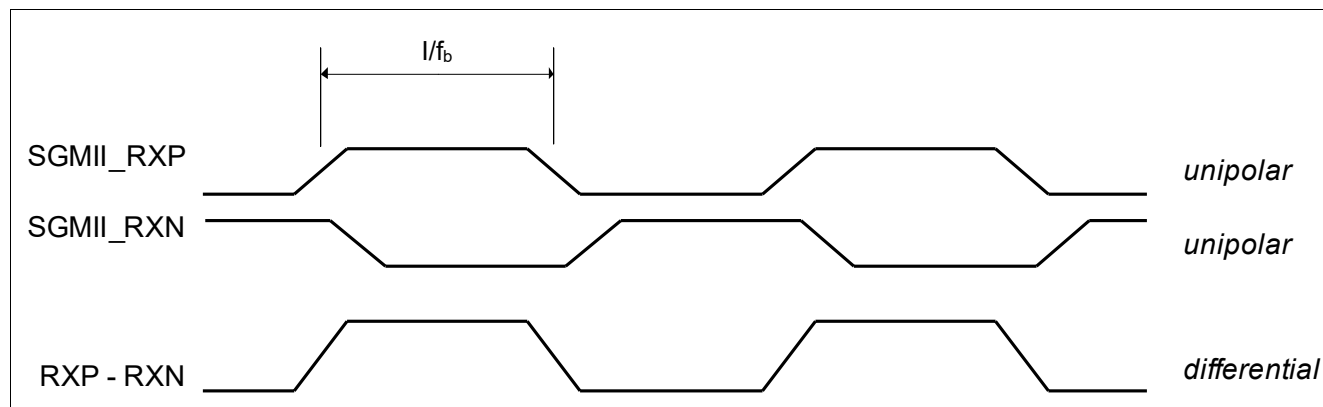

Figure 23 Receive Timing Diagram of the SGMII (alternating data input sequence)

Table 40 Receive Timing Characteristics of the SGMII

Parameter	Symbol	Values			Unit	Note / Test Condition
		Min.	Typ.	Max.		
Receive baud rate	f_b	-100 ppm	f_b	+100 ppm	Mbaud	$f_b = 1.25/3.125$ Gbaud
Receive data jitter tolerance	R_TJ	–	–	0.6	UI _{pp} ¹⁾	–
Input differential voltage	V _{ID}	200	–	1600	mV	peak-peak amplitude
Input impedance (differential)	R _I	80	100	120	Ω	–

1) Refer to [1] for details.

7.5.6 Serial Peripheral Interface (SPI)

The SPI master interface timing is shown in [Figure 24](#).

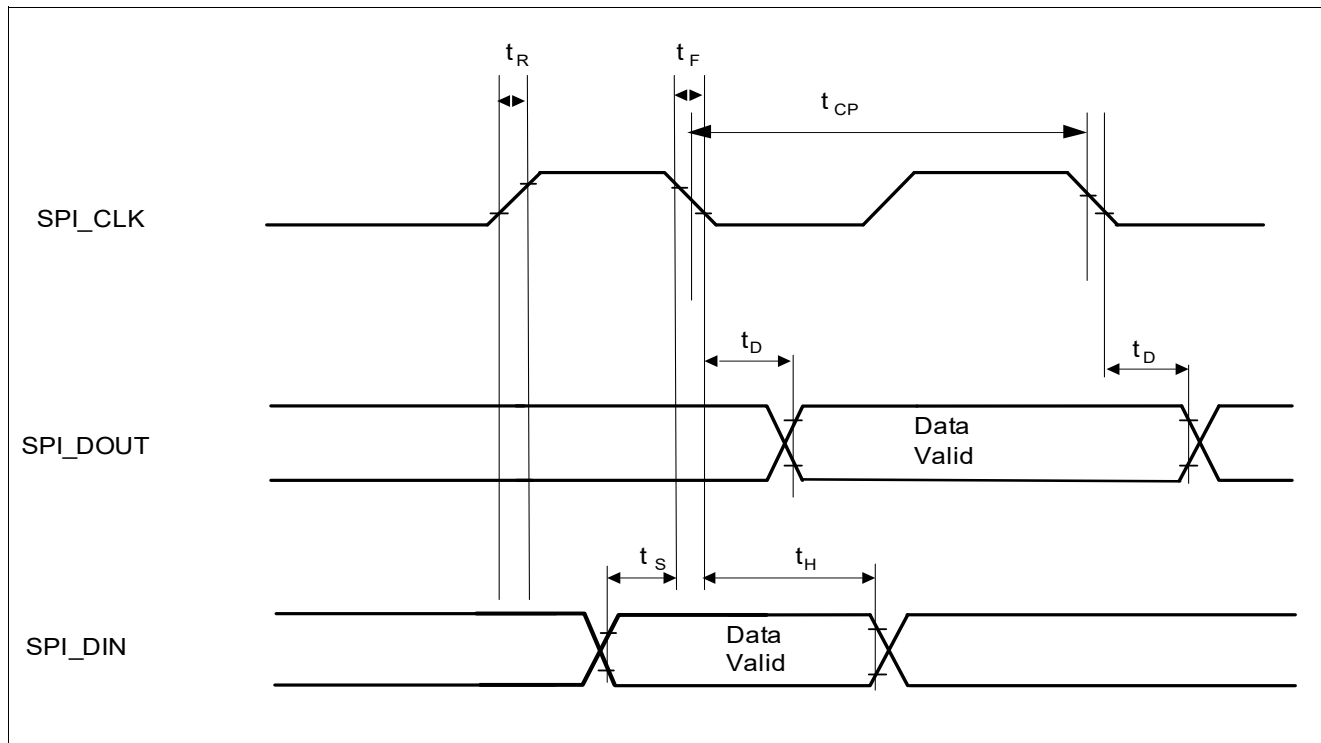

Figure 24 SPI Master Interface Timing

Table 41 SPI Interface Timing Parameters

Parameter	Symbol	Values			Unit	Note / Test Condition
		Min.	Typ.	Max.		
Master Mode						
Tx Data Output Delay	t_D	0	–	4	ns	–
Rx Data Input Setup Time	t_S	7	–	–	ns	–
Rx Data Hold Time	t_H	0	–	–	ns	–
SPI Clock Period (Master Mode)	t_{CP}	20	–	50	ns	–
SPI Clock Rise Time	t_R	–	–	5.0	ns	10% - 90%
SPI Clock Fall Time	t_F	–	–	5.0	ns	10% - 90%
SPI Clock Duty Cycle	D	45	–	55	%	–

7.5.7 JTAG Interface

The JTAG interface is used for boundary scan.

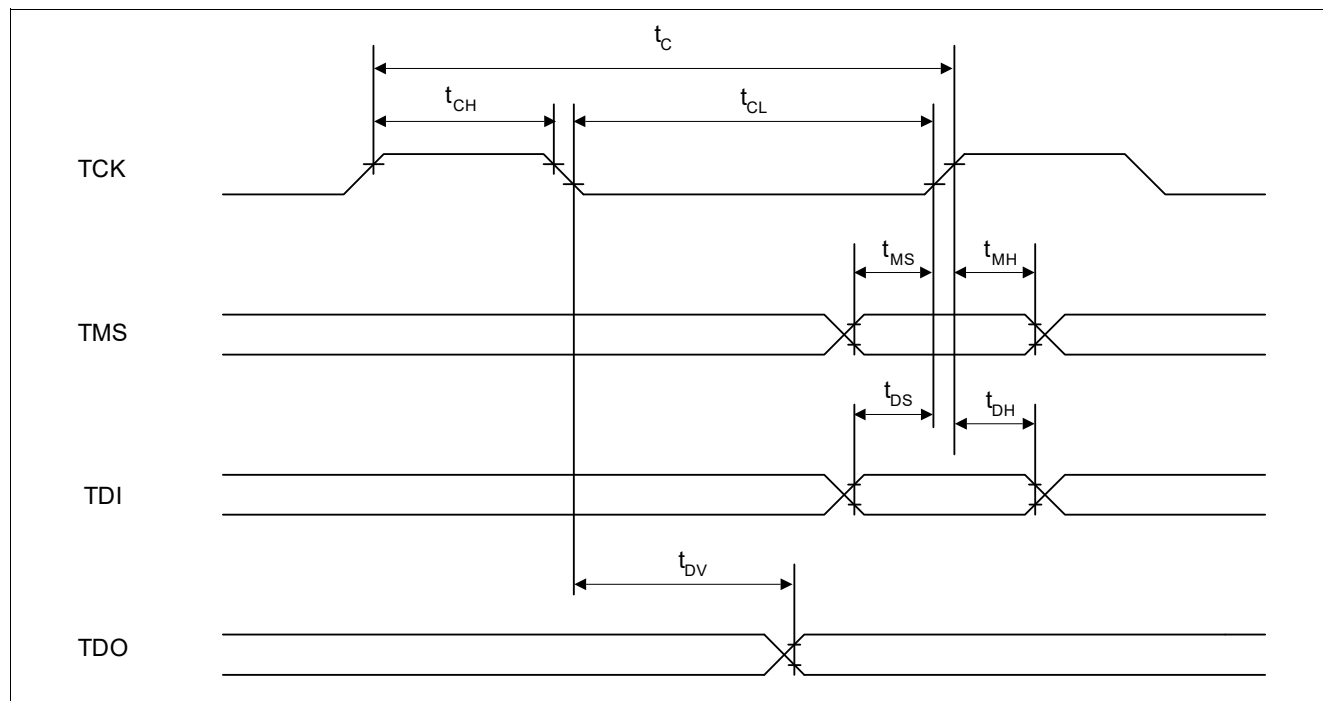

Figure 25 JTAG Interface Timing

The timing values are described in [Table 42](#) and [Table 43](#).

Table 42 JTAG Interface Clock

Parameter	Symbol	Values			Unit	Note / Test Condition
		Min.	Typ.	Max.		
TCK Clock Period	t_C	100	–	–	ns	–
TCK High Time	t_{CH}	40	–	–	ns	–
TCK Low Time	t_{CL}	40	–	–	ns	–

Table 43 JTAG Timing

Parameter	Symbol	Values			Unit	Note / Test Condition
		Min.	Typ.	Max.		
TMS setup time	t_{MS}	40	–	–	ns	–
TMS hold time	t_{MH}	40	–	–	ns	–
TDI setup time	t_{DS}	40	–	–	ns	–
TDI hold time	t_{DH}	40	–	–	ns	–
Hold: \overline{TRST} after TCK	t_{HD}	10	–	–	ns	–
TDO valid delay	t_{DV}	–	–	60	ns	–

7.5.8 Crystal Specification

The 25 MHz crystal must follow the specification given in [Table 44](#).

Table 44 Specification of the Crystal

Parameter	Symbol	Values			Unit	Note / Test Condition
		Min.	Typ.	Max.		
Frequency with 25 MHz input	f_{clk25}	–	25.0	–	MHz	–
Total Frequency Stability	–	-50	–	+50	ppm	Refers to sum of all effects: e.g. general tolerance, aging, temperature dependency
Series Resonant Resistance	–	–	–	60	Ω	–
Drive Level	–	–	–	0.1	mW	–
Load Capacitance	C_L	–	18	–	pF	–
Shunt Capacitance	C_0	–	–	5	pF	–

7.6 External Circuitry

This chapter specifies the component characteristics of the external circuitry connected to the GPY115.

7.6.1 Twisted-Pair Common-Mode Rejection and Termination Circuitry

This section describes the external circuitry that is required to properly terminate the common mode of the Twisted Pair Interface (TPI). These external components are also required to perform proper rejection of alien disturbers injected into the common mode of the TPI. **Figure 26** shows a typical external circuit, and in particular the common-mode components. **Table 45** defines the component values and their supported tolerances.

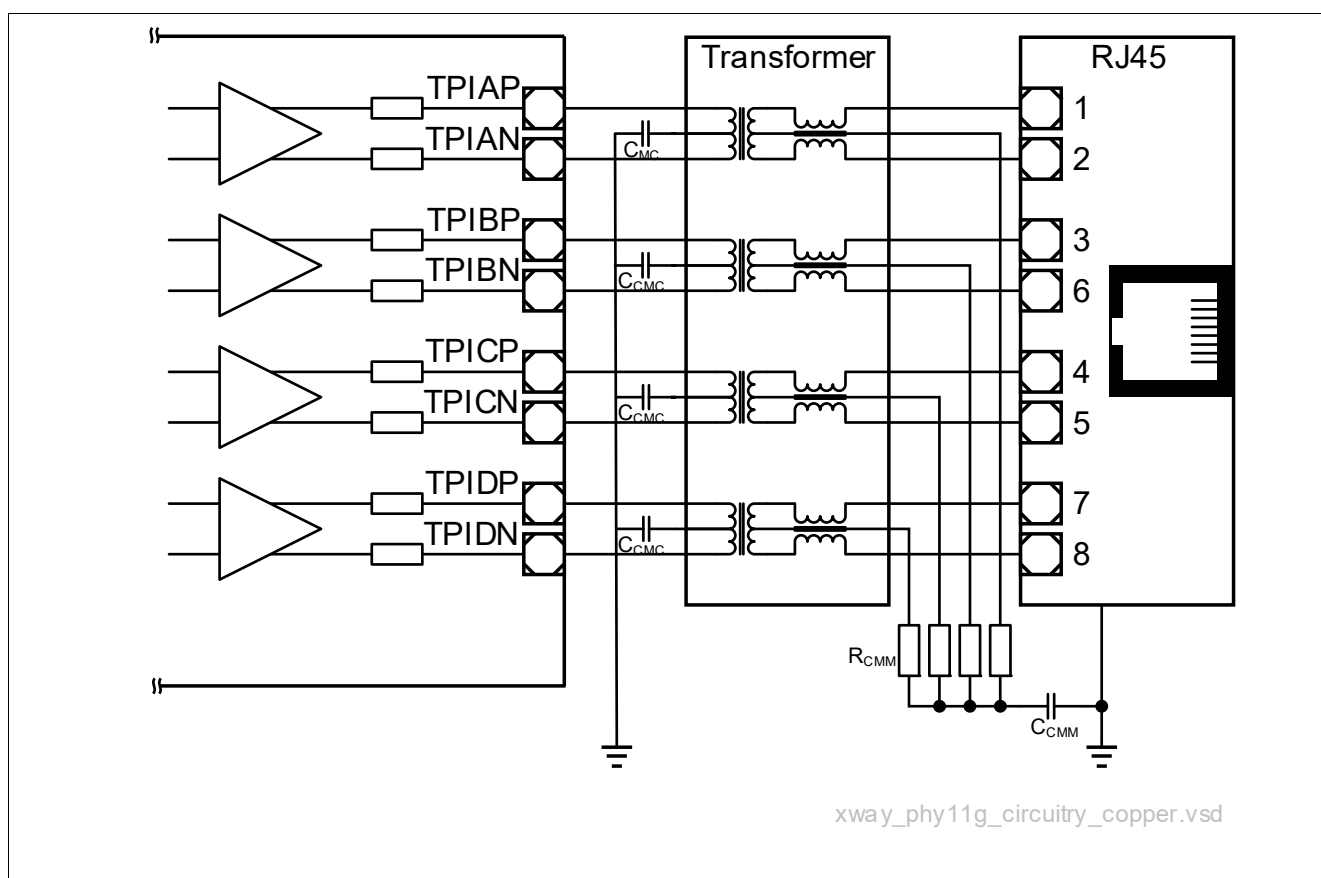

Figure 26 Twisted Pair Common-Mode Rejection and Termination Circuitry

Table 45 Electrical Characteristics for Common-Mode Rejection and Termination Circuitry

Parameter	Symbol	Values			Unit	Note / Test Condition
		Min.	Typ.	Max.		
Common-mode de-coupling capacitance (media end)	C_{CMM}	800	1000	1200	pF	±20%, 2 kV
Common-mode de-coupling capacitance (chip end)	C_{CMC}	80	100	120	nF	±20%, 2 kV
Common-mode termination resistance (media end)	R_{CMM}	67.5	75	82.5	Ω	±10%

7.6.2 Transformer (Magnetics)

This section specifies the required electrical characteristics of the transformer¹⁾ devices that are supported. The specifications listed here guarantee proper operation according to IEEE 802.3 [2].

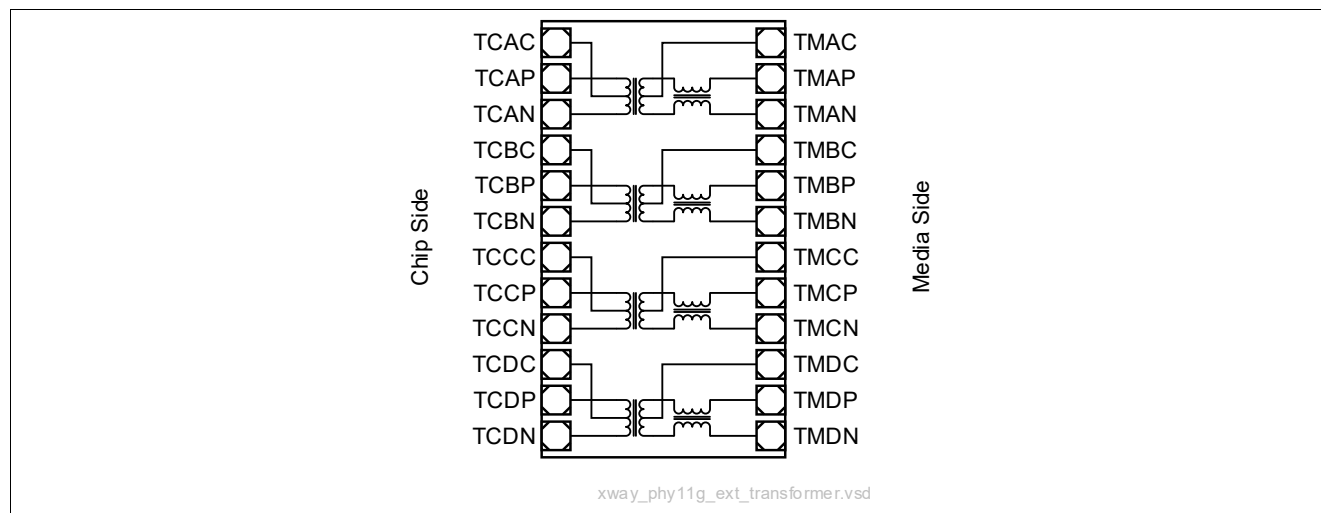

Figure 27 Schematic of an Ethernet Transformer Device

A typical Gigabit Ethernet capable transformer device is depicted in **Figure 27**. **Table 46** lists the characteristics of the supported transformer devices. Note that these characteristics represent the minimum for achieving standard performance. Since the transformer significantly impacts the link performance, it is possible to increase the loop reach by selecting transformers with improved parameters.

Table 46 Electrical Characteristics for Supported Transformers (Magnetics)

Parameter	Symbol	Values			Unit	Note / Test Condition
		Min.	Typ.	Max.		
Turns Ratio	1:tr	0.95	1.00	1.05		±5%
Differential-to-common-mode rejection	DCMR	40	–	–	dB	30 MHz
		35	–	–	dB	60 MHz
		30	–	–	dB	100 MHz
Crosstalk attenuation	CTA	45	–	–	dB	30 MHz
		40	–	–	dB	60 MHz
		35	–	–	dB	100 MHz
Insertion loss	IL	–	–	1	dB	1 MHz ≤ f ≤ 250 MHz
Return loss	RL	16	–	–	dB	1 MHz ≤ f ≤ 40 MHz
Return loss	RL	16-10*log ₁₀ (f/40)	–	–	dB	40 MHz ≤ f ≤ 125 MHz

1) Also often referred to as “magnetics”.

7.6.3 RJ45 Plug

Table 47 describes the electrical characteristics of the RJ45 plug to be used in conjunction with the GPY115.

Table 47 Electrical Characteristics for Supported RJ45 Plugs

Parameter	Symbol	Values			Unit	Note / Test Condition
		Min.	Typ.	Max.		
Crosstalk attenuation	CTA	45	–	–	dB	30 MHz
		40	–	–	dB	60 MHz
		35	–	–	dB	100 MHz
Insertion loss	IL	–	–	1	dB	1 MHz ≤ f ≤ 250 MHz
Return loss	RL	16	–	–	dB	1 MHz ≤ f ≤ 40 MHz
Return loss	RL	16-10*log ₁₀ (f/40)	–	–	dB	40 MHz ≤ f ≤ 250 MHz

7.6.4 Calibration Resistors

An external resistor R_{CAL} of 22 kΩ 1% must be connected between the RCAL pin and ground to calibrate the GPY115 Ethernet analog modules.

Additionally, an external resistor R_{RESREF} of 200 Ω 1% must be connected between the RESREF pin and ground to calibrate the GPY115 SGMII analog modules.

The resistor values are indicated in **Table 48**.

Table 48 Calibration Resistors Values

Parameter	Symbol	Values			Unit	Note / Test Condition
		Min.	Typ.	Max.		
GPY115 calibration resistor	R_{CAL}	21780	22000	22220	Ω	±1%
SGMII PHY calibration resistor	R_{RESREF}	198	200	202	Ω	±1%

7.7 Power Supply

Due to its integrated DC/DC SVR converter, the GPY115 can be powered using a single power supply, as described in the next section. However, the device can also be powered without the integrated DC/DC converter. **Figure 28** and **Figure 29** show the high-level principle of circuitry. For more details, refer to Reference Board Hardware Design Guide [6].

7.7.1 Power Supply Using Integrated DC/DC SVR Converter

The GPY115 can be powered using a single 3.3 V supply when the integrated DC/DC converter is used. As long as the applied nominal voltage remains within the operating range specified in **Chapter 7.2**, the device operates automatically and without the need for additional settings to be applied. Only minor external circuitry is required to enable this feature. **Figure 28** shows an example schematic. The electrical characteristics of the power supply are defined in **Chapter 7.2**.

The required values for the external components are listed in **Table 49**.

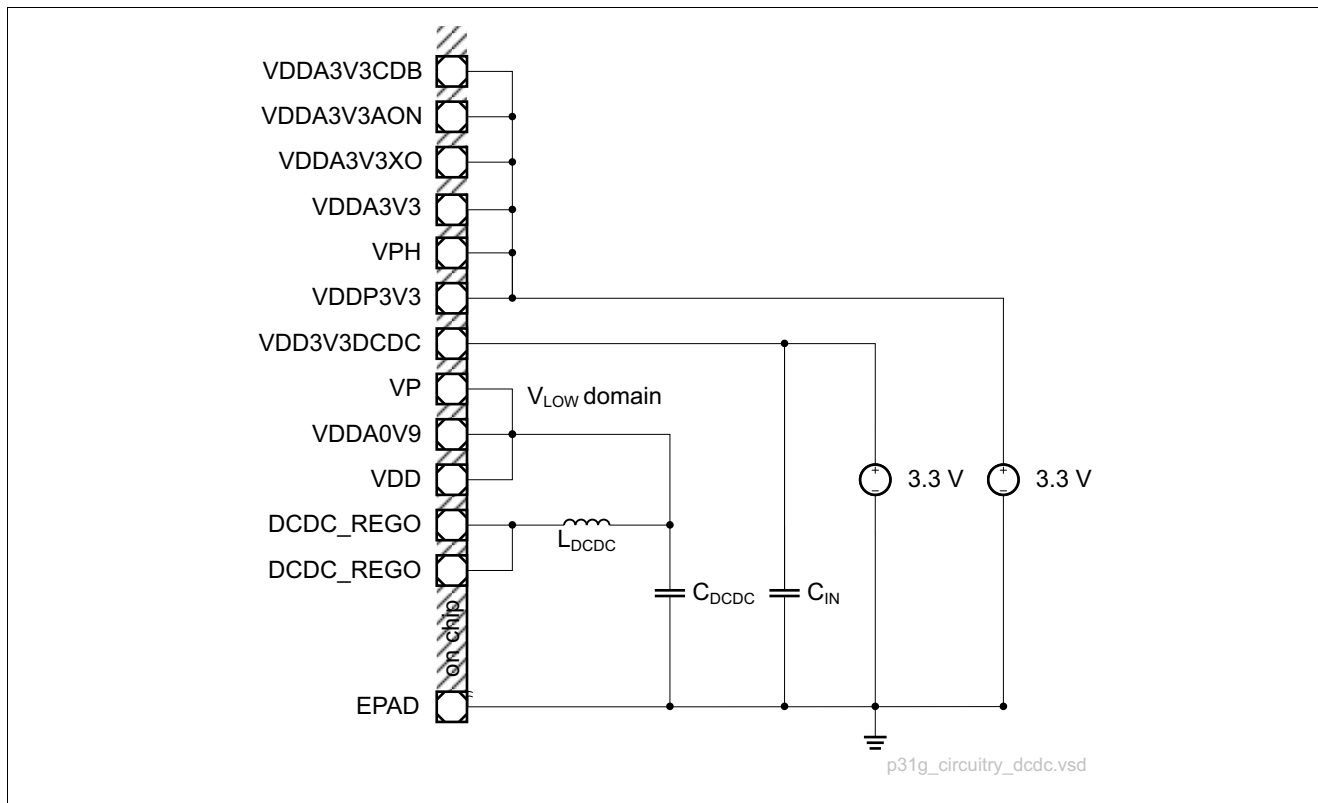

Figure 28 External Circuitry Using the Integrated DC/DC Converter

Table 49 External Component Values for DC/DC Converter

Parameter	Symbol	Values			Unit	Note / Test Condition
		Min.	Typ.	Max.		
DC/DC buck inductance	L_{DCDC}	–	1.0	–	μH	$\text{DCR}_{\text{max}} = 0.07 \text{ ohm}$
DC/DC smoothing capacitance	C_{DCDC}	–	2 x 22	–	μF	Refer to [6] for exact reference circuitry
			1 x 330		pF	
DC/DC input capacitance	C_{IN}	–	10.0	–	μF	Refer to [6] for exact reference circuitry
			22			
			0.1			

7.7.2 Power Supply without using Integrated DC/DC Converter

When the integrated DC/DC converter is not used, for example when both power supply voltages are already available in the system, the GPY115 can be powered by a dual power supply, as shown in **Figure 29**. The electrical characteristics of the power supply are defined in **Chapter 7.2**.

In external supply mode, the DC/DC converter output pins are left unconnected. The integrated DC/DC converter can then be switched off after power up. Note that **Figure 29** is only a generic schematic, and does not show power supply blocking for reasons of simplicity.

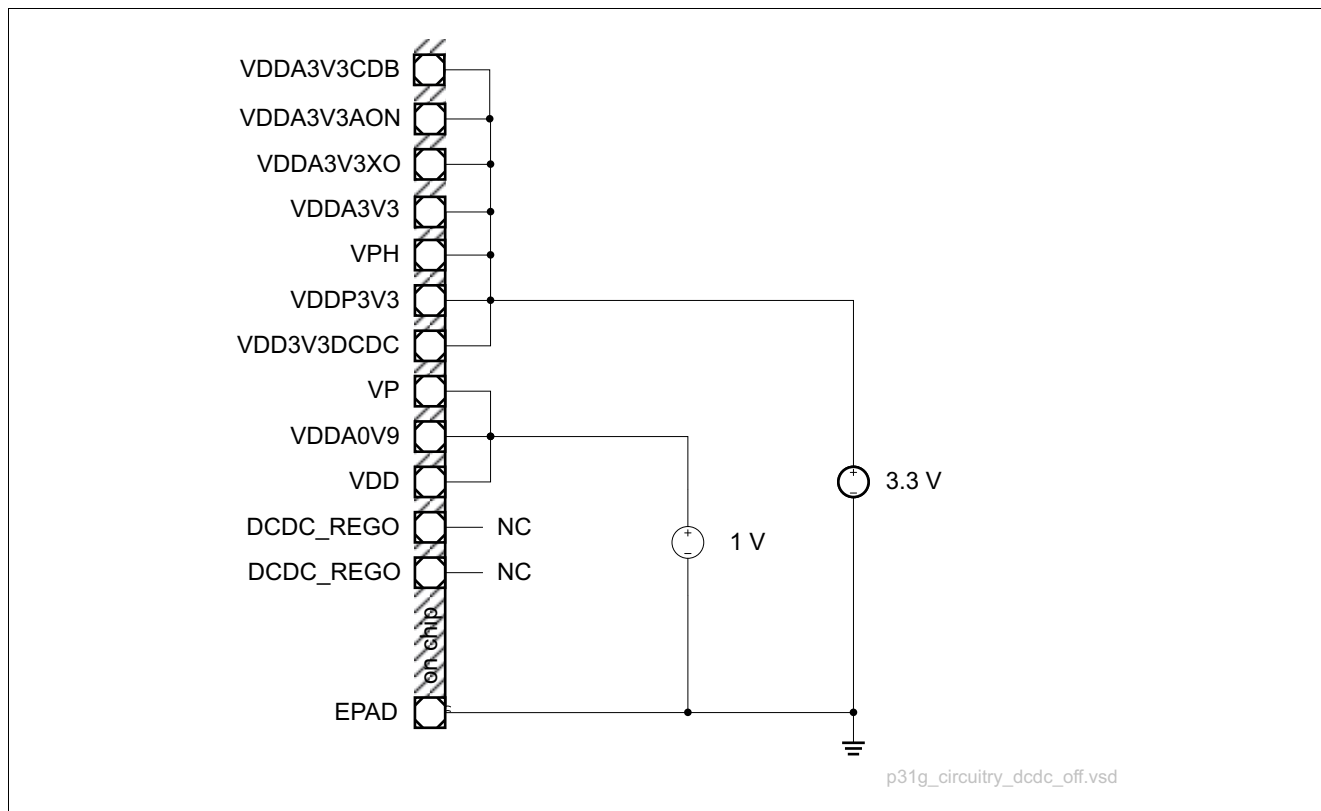

Figure 29 External Circuitry without using the Integrated DC/DC Converter

8 Package Outline

The product is assembled in a PG-VQFN-56 package, which complies with regulations requiring lead free material. The following parameters are generated in accordance with JEDEC JESD51 standards [9]. Three models are provided:

- in natural convection environment, still air (Table 50)
- with a thermal solution setting chip top temperature at 70°C (Table 51)
- according to compact 2-R model (Table 52)

Table 50 JEDEC Thermal Resistance Package Parameter - Still air conditions

Item	Name/Value
Environmental conditions	The chip is mounted on a 4-layer PCB (2S2P) according to JESD51-7 [9], PCB size 76.2x114 mm Natural convection: still air, according to JESD51-2 [9] Ambient temperature: 85°C
Thermal Resistance - Junction to Ambient	$R_{th,JA} = 23 \text{ K/W}$
Thermal Delta - Junction to Case Top	$\Psi_{jCtop} = 0.53 \text{ K/W}$

Table 51 JEDEC Thermal Resistance Package Parameter - With Thermal Solution Environment

Item	Name/Value	Environment
Thermal Resistance Junction to Case Top	$R_{th,JCtop} = 18.2 \text{ K/W}$	Cold plate on package top surface. Temp = 70°C. PCB with 16 thermal vias
Thermal Resistance - Junction to Case Bottom	$R_{th,JB} = 12.8 \text{ K/W}$	As per JESD51-8 [9] Ring style cold plate on PCB around 3 mm from package edge. Temp = 70°C. PCB with 16 thermal vias.

Table 52 JEDEC Thermal Resistance Package Parameter - Compact 2-R Model Network

Item	Name/Value
Thermal Resistance Junction to Case Top	$R_{th,JCtop} = 24.6 \text{ K/W}$
Thermal Resistance - Junction to Case Bottom	$R_{th,JCbottom} = 5.24 \text{ K/W}$

The mechanical drawings for this package are shown in **Figure 30**. Dimensions are in millimeters.

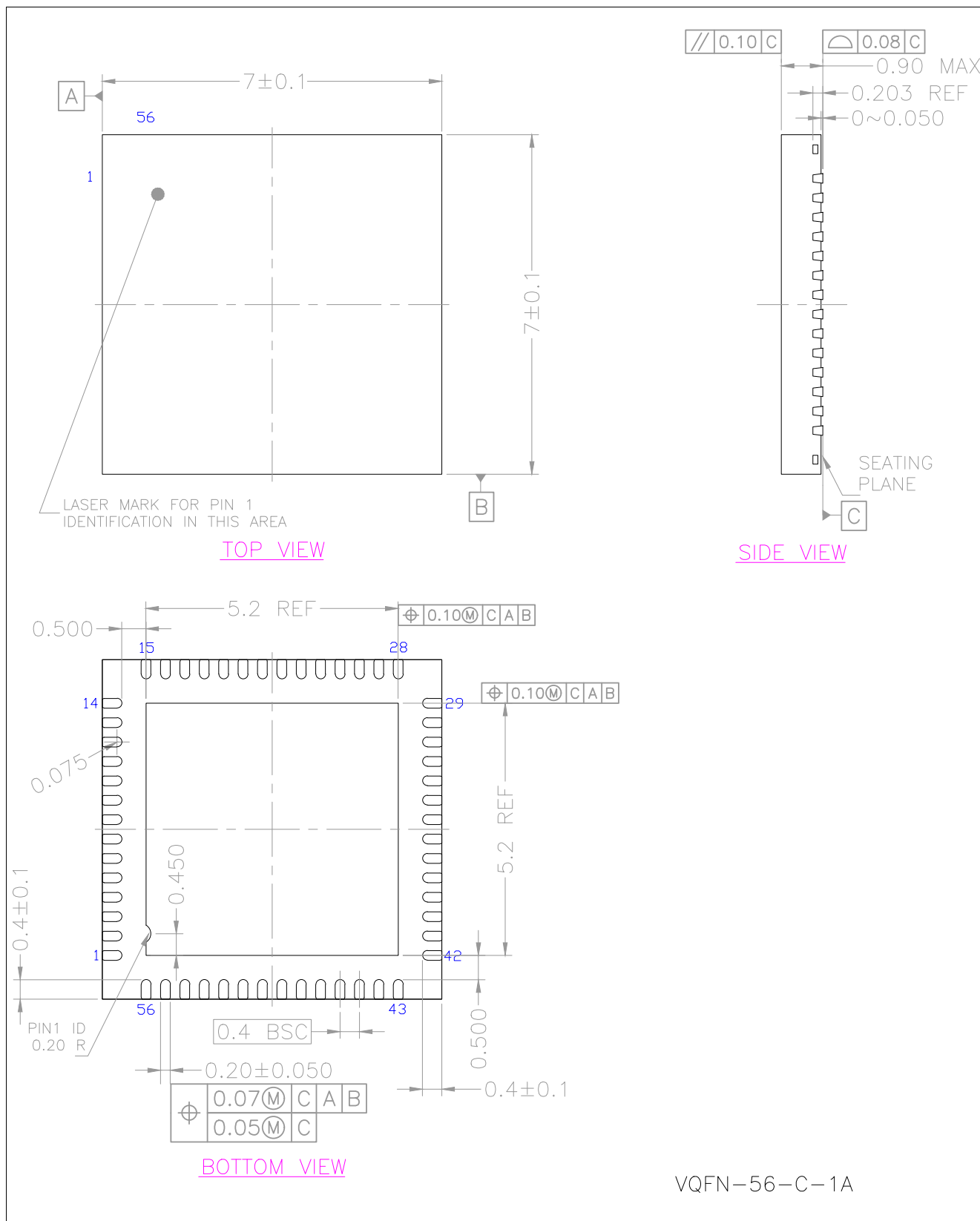

Figure 30 PG-VQFN-56 7 mm x 7 mm Package Outline

8.1 Chip Identification and Ordering Information

Figure 31 shows an example of the marking pattern on the Gigabit Ethernet PHY GPY115 device. The actual chip marking may differ slightly from the illustration.

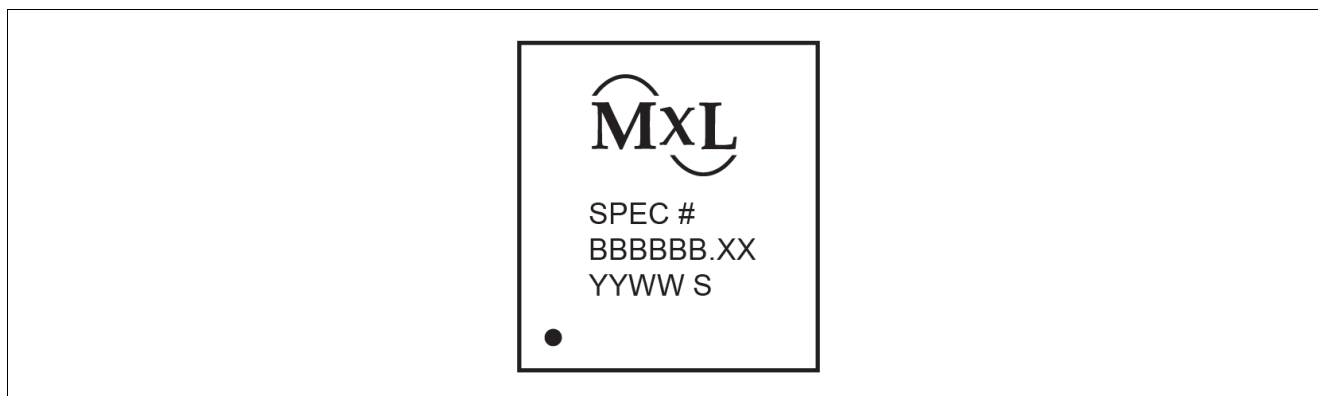

Figure 31 Example of Chip Marking

Table 53 explains the chip marking information, **Table 54** provides chip ordering information for GPY115C0VI, and **Table 55** provides chip ordering information for GPY115B1VI.

Table 53 Chip Marking Pattern

Marking	Description
Text Line 1	MaxLinear Logo
Text Line 2	Spec. Number - See Table 54 (GPY115C0VI) and Table 55 (GPY115B1VI)
Text Line 3	Wafer Lot Number
Text Line 4	Date Code (YYWW) and Assembly Site Code (S)

Table 54 Product Naming (GPY115C0VI)

Product Name	Ordering Code	S-Spec# ¹⁾	MMID	OTP Firmware Version	Device Number ²⁾	Device Revision Number ³⁾	PHY Identifier ⁴⁾
GPY115	GPY115C0VI	SLNWA	99AFCA	0x886F	0x31	0x0	0xDF10

1) Marking of Engineering Sample is QW6G with MMID xxxxx. OTP, Device Number, Device Revision Number and PHY Identifier identical to S-Spec part.

2) LDN field in CL22 and CL45 registers.

3) LDRN field in CL22 and CL45 registers.

4) PHY Identifier 2 register 16-bit value.

Table 55 Product Naming (GPY115B1VI)

Product Name	Ordering Code	S-Spec#	MMID	OTP Firmware Version	Device Number ¹⁾	Device Revision Number ²⁾	PHY Identifier ³⁾
GPY115	GPY115B1VI	SLNBZ	999N9H	0x8747	0x30	0x3	0xDF03

1) LDN field in CL22 and CL45 registers.

2) LDRN field in CL22 and CL45 registers.

3) PHY Identifier 2 register 16-bit value.

Terminology

A

ADS	Auto-Downspeed
ANEG	Auto-Negotiation
ANSI	American National Standards Institute

B

BER	Bit Error Rate
BW	Bandwidth

C

CAT5	Category 5 Cabling
CCR	Configuration Content Record
CDR	Clock and Data Recovery
CRC	Cyclic Redundancy Check
CSR	Configuration Signature Record
CRS	Carrier Sense

D

DEC	Digital Echo Canceler
-----	-----------------------

E

ECM	Externally Controlled Mode (LED)
EEE	Energy-Efficient Ethernet
EEPROM	Electrically Erasable Programmable ROM
EMI	Electromagnetic Interference
ESD	Electrostatic Discharge

F

FFU	Field Firmware Upgrade
FLP	Fast Link Pulse
FO	Fiber-Optic

G

GbE	Gigabit Ethernet
GBIC	Gigabit Interface Converter
GMII	Gigabit Media-Independent Interface
GPIO	General Purpose Input/Output

H

HBM	Human Body Model
HSTL	High-Speed Transceiver Logic
HYB	Hybrid

I

IC	Integrated Circuit
ICM	Internally Controlled Mode (LED)

ICV	Integrity Check Value
IEEE	Institute of Electrical and Electronics Engineers
IPG	Inter-Packet Gap
J	
JTAG	Joined Test Action Group
L	
LAN	Local Area Network
LED	Light Emitting Diode
LPI	Low Power Idle
LSB	Least Significant Bit
M	
MAC	Media Access Controller
MDI	Media-Dependent Interface
MDIO	Management Data Input/Output
MDIX	Media-Dependent Interface Crossover
MII	Media-Independent Interface
MMD	MDIO Manageable Device
MoCA	Multimedia over Coax Alliance
MSB	Most Significant Bit
N	
NAS	Network Attached Storage
NLP	Normal Link Pulse
NP	Next Page
O	
OSI	Open Systems Interconnection
OTP	One-Time Programmable Memory
OUI	Organizationally Unique Identifier
P	
PCB	Printed Circuit Board
PCS	Physical Coding Sublayer
PD	Powered Device
PHY	Physical Layer (device)
PICMG	PCI Industrial Computer Manufacturers Group
PLL	Phase-Locked Loop
PMA	Physical Media Attachment
PON	Passive Optical Network
PPS	Pulse Per Second
PTS	Precision Time Protocol
PSE	Power-Sourcing Equipment
R	

RX	Receive
S	
SA	Secure Association
SC	Secure Channel
SerDes	Serializer-Deserializer
SFD	Start-of-frame Delimiter
SFP	Small Form-Factor Pluggable
SGMII	Serial Gigabit Media-Independent Interface
SMD	Surface Mounted Device
SoC	System on Chip
STA	Station Management Entity (MAC SoC)
SVR	Switching Voltage Regulator (Internal DCDC)
T	
TAP	Test Access Port
TPI	Twisted Pair Interface
TsSync	Time Stamp Synchronization
TX	Transmit
V	
VQFN	Very Thin Quad Flat Non-leaded
W	
Wi-Fi	Wireless Local Area Network
WoL	Wake-on-LAN
X	
xMII	Symbolic shortening which denotes the set of supported MII Interfaces, e.g. RGMII and SGMII

References

- [1] Common Electrical I/O (CEI) – Electrical and Jitter Interoperability agreements for 6G+ bps and 11G+ bps I/O (IA # OIF-CEI-02.0) 28th February 2005
- [2] IEEE 802.3-2018: “Carrier sense multiple access with collision detection (CSMA/CD) access method and physical layer specifications”, IEEE Computer Society
- [3] Serial-GMII Specification: Revision 1.8, Cisco* Systems, November 2 2005
- [4] Sync-E Jitter and Wander specification ITU-T G.8262: “Timing characteristics of a synchronous Ethernet equipment slave clock”
- [5] IEEE 1588-2008: “IEEE Standard for a Precision Clock Synchronization Protocol for Networked Measurement and Control Systems”
- [6] Ethernet Network Connection EASY GPY211 LBB Reference Board V1.3.1 HDK HW7.02 Hardware Design Guide Rev. 1.0
- [7] Ethernet Network Connection GPY API Programmer's Guide Rev. 3.0