

Revision History

REV.	Description	Date	APP'D
A	DRAWING ORIGATION	JAN/17/2018	ECN 1808-06 jh

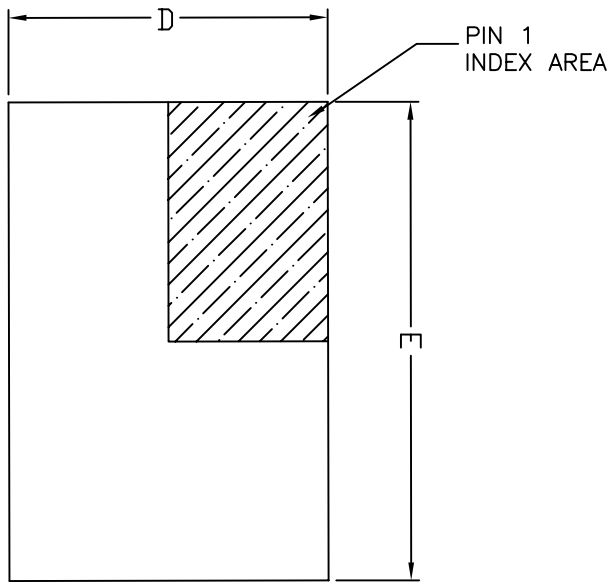

TOP VIEW

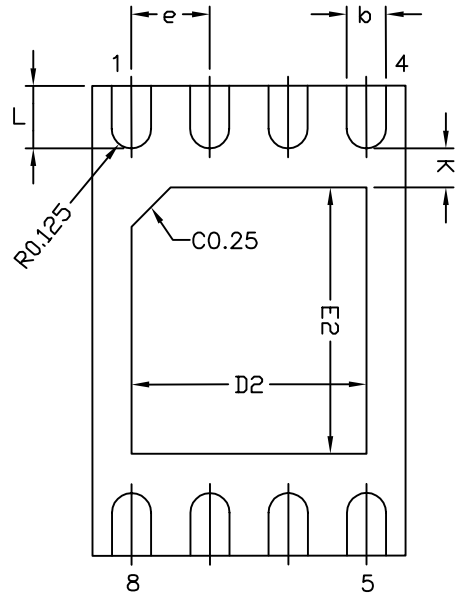

BOTTOM VIEW

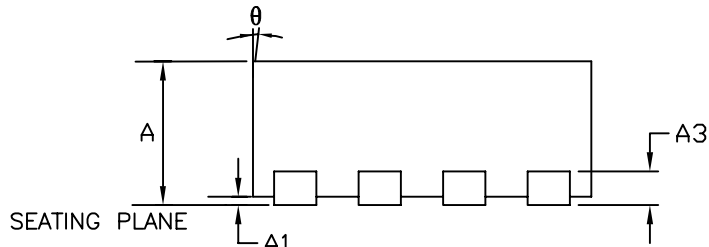

SIDE VIEW

DIM SYMBOL	MIN	NOM	MAX
A	0.80	0.90	1.00
A1	0.00	0.02	0.05
A3	0.20 REF		
b	0.18	0.25	0.30
D	2.00 BSC		
E	3.00 BSC		
e	0.50 BSC		
D2	1.50	-	1.75
E2	1.60	-	1.90
K	0.20	-	-
L	0.30	0.40	0.50
θ	0	-	14
N	8		

TERMINAL DETAILS

- ALL DIMENSIONS ARE IN MILLIMETERS, ANGLES ARE IN DEGREES.
- DIMENSIONS AND TOLERANCE PER JEDEC MO-229.

	MAXLINEAR CORPORATION	
	8DFN 2X3 Package Outline Drawing	
Packaging Approval:		Drawing No.: POD-000000132
By: YG Eom	Date: JAN.17.2018	Revision: A
Sheet 1 OF 2		

Revision History			
REV.	Description	Date	APP'D
A	DRAWING ORIGINATION	JAN/17/2018	ECN 1808-06 jh

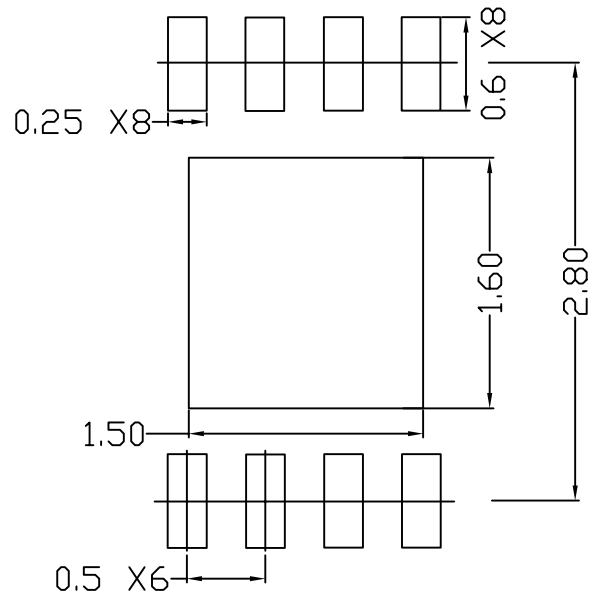

TYPICAL RECOMMENDED LAND PATTERN

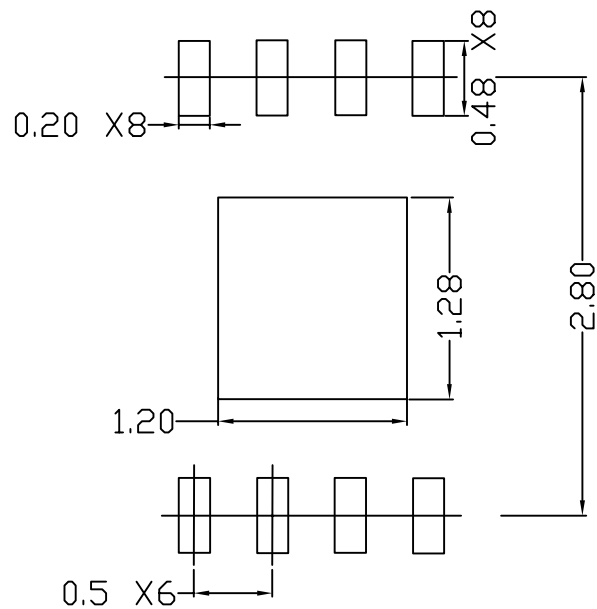

TYPICAL RECOMMENDED STENCIL

		MAXLINEAR CORPORATION	
		8DFN 2X3 Package Outline Drawing	
Packaging Approval:		Drawing No.: POD-000000 132	Sheet 2 OF 2
By: YG Eom	Date: JAN.17.2018	Revision: A	