

| REVISION HISTORY | | | |
|------------------|---------------------|----------|-------|
| REV. | DISCRIPTION | DATE | APP'D |
| A | DRAWING ORIGINATION | 08/07/09 | PC |

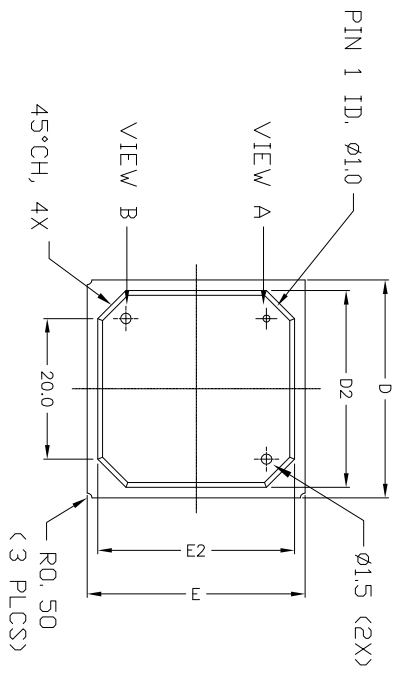

TOP VIEW

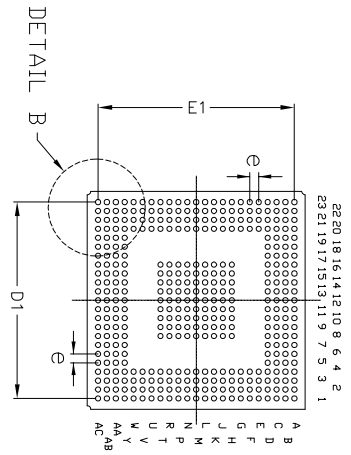

BOTTOM VIEW

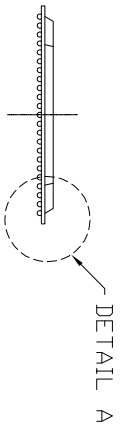

SIDE VIEW

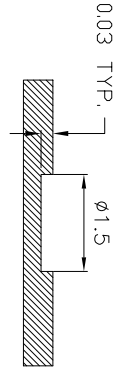

VIEW B

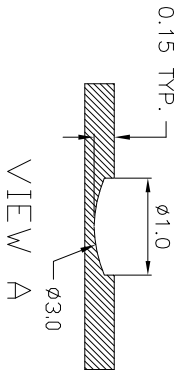

VIEW A

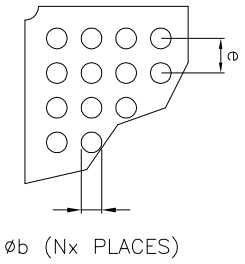

DETAIL B

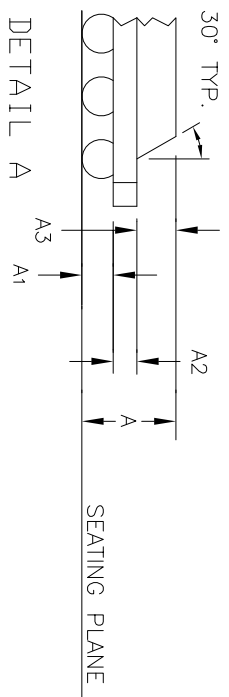

DETAIL A

| SYMBOLS | DIMENSIONS IN MM (Control Unit) | | | DIMENSIONS IN INCH (Reference Unit) | | |
|---------|---------------------------------|-------|-------|-------------------------------------|-------|-------|
| | MIN | NOM | MAX | MIN | NOM | MAX |
| A | 2.17 | 2.33 | 2.49 | 0.085 | 0.092 | 0.098 |
| A1 | 0.50 | 0.60 | 0.70 | 0.020 | 0.024 | 0.028 |
| A2 | 0.52 | 0.56 | 0.60 | 0.020 | 0.022 | 0.024 |
| A3 | 1.15 | 1.17 | 1.19 | 0.045 | 0.046 | 0.047 |
| D | 30.80 | 31.00 | 31.20 | 1.213 | 1.220 | 1.228 |
| D1 | 27.94 BSC | | | 1.100 BSC | | |
| D2 | 27.90 | 28.00 | 28.10 | 1.098 | 1.102 | 1.106 |
| E | 30.80 | 31.00 | 31.20 | 1.213 | 1.220 | 1.228 |
| E1 | 27.94 BSC | | | 1.100 BSC | | |
| E2 | 27.90 | 28.00 | 28.10 | 1.098 | 1.102 | 1.106 |
| b | 0.60 | 0.75 | 0.90 | 0.024 | 0.030 | 0.035 |
| e | 1.27 BSC | | | 0.050 BSC | | |
| M | 23 | | | 23 | | |
| N | 385 | | | 385 | | |

NOTES: "M" REPRESENTS THE SOLDER BALL MATRIX SIZE.

| | | | |
|---------------------|----------------|---------------------------------------|---------------|
| | | EXAR CORPORATION | |
| | | 385-BALL 31X31mm PBGA PACKAGE OUTLINE | |
| Packaging Approval: | | Drawing No: 385-BALL 31X31mm PBGA | |
| By: PC | Date: 08/07/09 | Revision: A | Sheet: 1 OF 1 |